

D3270022
sup.vista mm. 157
Kg./m 1.201

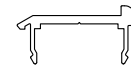

D3270017
sup.vista mm. 45
Kg./m 0.367

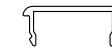

D3270018
sup.vista mm. 34
Kg./m 0.208

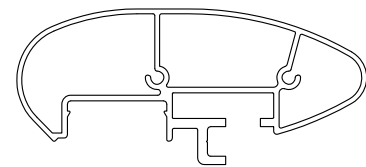

D3270013
sup.vista mm. 183
Kg./m 1.731
TAPPO DX D020D103
TAPPO SX D020D104



D3270011
sup.vista mm. 36
Kg./m 0.572
TAPPO DX D020D107
TAPPO SX D020D108



D3270016
sup.vista mm. 25
Kg./m 0.350
TAPPO D020F112



D3270020
sup.vista mm. 84
Kg./m 0.386

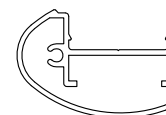

D3270021
sup.vista mm. 105
Kg./m 0.751
TAPPO DX D020D101
TAPPO SX D020D102

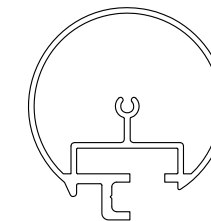

D3270019
sup.vista mm. 159
Kg./m 1.350
TAPPO D020D100

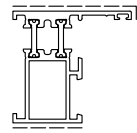

D1210504
sup.vista mm. 80
Kg./m 1.000

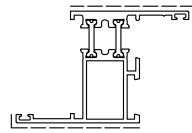

D1210501
sup.vista mm. 108
Kg./m 1.100

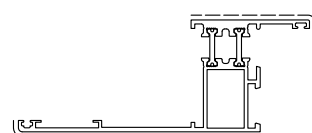

D1210995
sup.vista mm. 153
Kg./m 1.384

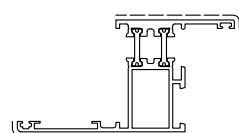

D1210657
sup.vista mm. 123
Kg./m 1.197

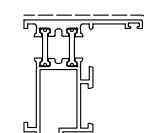

D1210655
sup.vista mm. 86
Kg./m 1.095

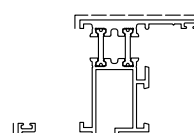

D1210618
sup.vista mm. 118
Kg./m 1.248

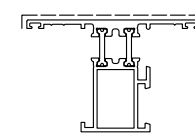

D1210503
sup.vista mm. 108
Kg./m 1.100

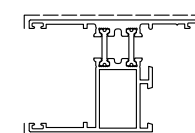

D1210605
sup.vista mm. 131
Kg./m 1.242

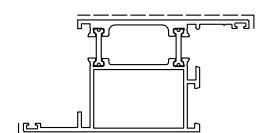

D1210544
sup.vista mm. 148
Kg./m 1.453

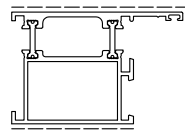

D1210542
sup.vista mm. 122
Kg./m 1.331

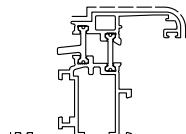

D1210546
sup.vista mm. 86
Kg./m 1.273

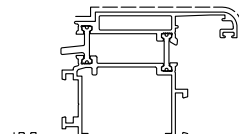

D1210622
sup.vista mm. 149
Kg./m 1.615

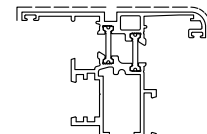

D1210628
sup.vista mm. 128
Kg./m 1.420
TAPPO EST. D0015D06
TAPPO INT. D4240032

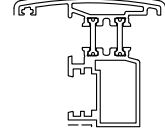

D1210637
sup.vista mm. 79
Kg./m 1.227
TAPPO D0015D32

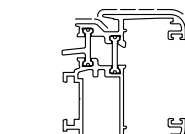

D1210674
sup.vista mm. 132
Kg./m 1.399

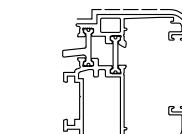

D1210509
sup.vista mm. 141
Kg./m 1.411

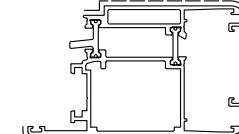

D1210626
sup.vista mm. 182
Kg./m 1.749

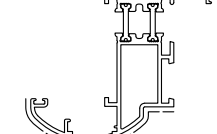

D1210149
sup.vista mm. 125
Kg./m 1.316

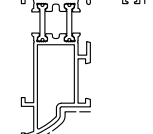

D1210152
sup.vista mm. 86
Kg./m 1.111

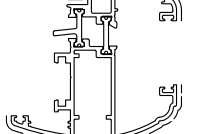

D1210150
sup.vista mm. 141
Kg./m 1.440



D3290001
sup.vista mm. 14
Kg./m 0.144

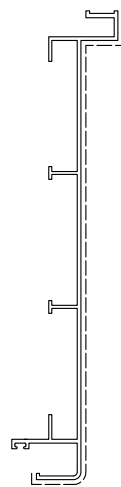

D3290066
sup.vista mm. 224
Kg./m 1.291
TAPPO D6240015

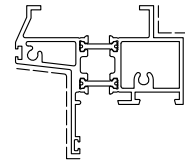

D1210528
sup.vista mm. 112
Kg./m 1.536

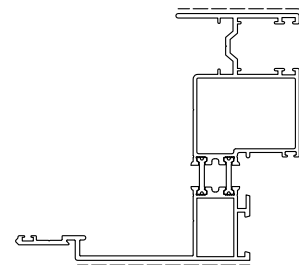

D1210650
sup.vista mm. 171
Kg./m 2.137
TAPPO D4240117



D3210017
kg/m. 0.118
sup. in vista mm. 30



D3091045
sup. in vista mm. 34
kg/m. 0.210
TAPPO D4040029 **SX**
TAPPO D4040030 **DX**



D3220132
sup.vista mm. =
Kg./m 0.197



D3220016
sup.vista mm. 20
Kg./m 0.300

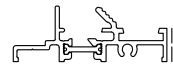

D1210631
sup.vista mm. 13
Kg./m 0.742



D3210016
sup.vista mm. 55
Kg./m 0.379

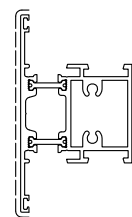

D1210514
sup.vista mm. 127
Kg./m 1.518

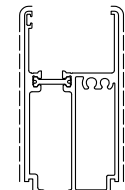

D1211001
sup.vista mm. 142
Kg./m 1.474

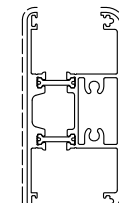

D1210520
sup.vista mm. 176
Kg./m 1.599
TAPPO D0015D07

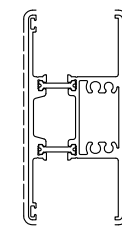

D1210257
sup.vista mm. 175
Kg./m 1.548

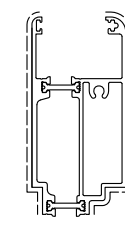

D1210615
sup.vista mm. 186
Kg./m 1.436

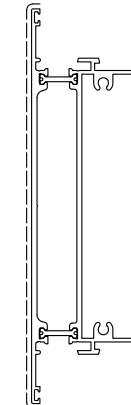

D1210518
sup.vista mm. 287
Kg./m 2.825

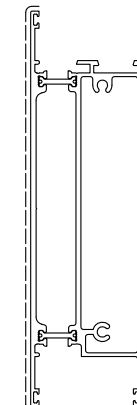

D1210524
sup.vista mm. 310
Kg./m 2.922

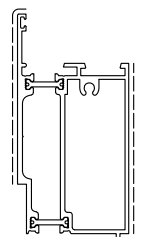

D1210604
sup.vista mm. 141
Kg./m 1.694

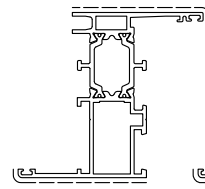

D1211002
kg/m. 1.391
sup. in vista mm. 111

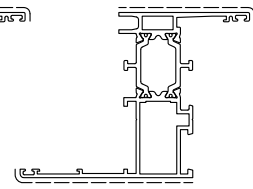

D1211018
kg/m. 1.474
sup. in vista mm. 129

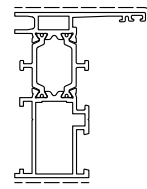

D1211003
kg/m. 1.279
sup. in vista mm. 86

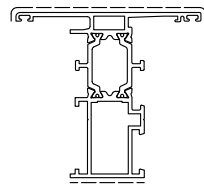

D1211004
kg/m. 1.391
sup. in vista mm. 110

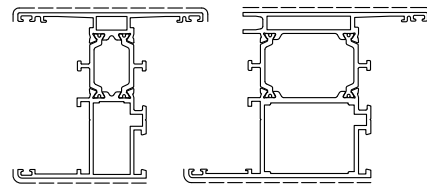

D1211006
kg/m. 1.477
sup. in vista mm. 135

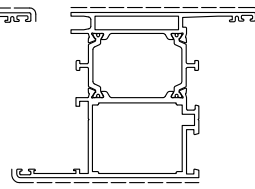

D1220064
kg/m. 1.887
sup. in vista mm. 155

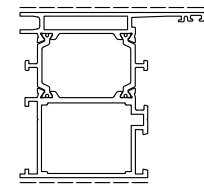

D1220065
kg/m. 1.773
sup. in vista mm. 130

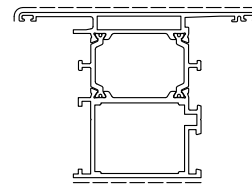

D1220066
kg/m. 1.884
sup. in vista mm. 155

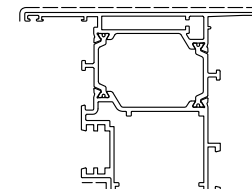

D1220073
kg/m. 2.130
sup. in vista mm. 175

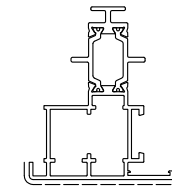

D1211040
kg/m. 1.366
sup. in vista mm. 87

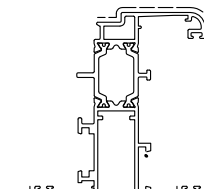

D1210154
kg/m. 1.439
sup. in vista mm. 104

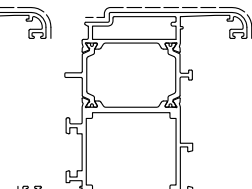

D1211021
kg/m. 1.991
sup. in vista mm. 149

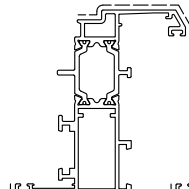

D1211022
kg/m. 1.438
sup. in vista mm. 104

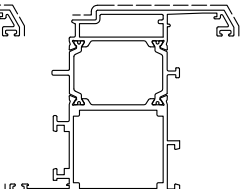

D1211023
kg/m. 1.987
sup. in vista mm. 150

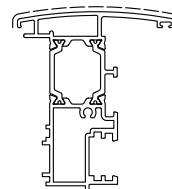

D1210007
kg/m. 1.502
sup. in vista mm. 85
TAPPO D4240101

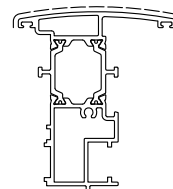

D1211039
kg/m. 1.463
sup. in vista mm. 84
TAPPO D4240102

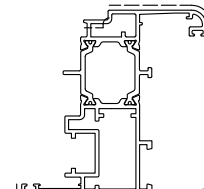

D1211009
kg/m. 1.612
sup. in vista mm. 116

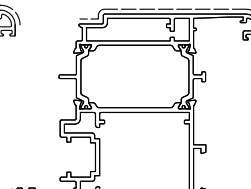

D1210107
kg/m. 2.205
sup. in vista mm. 163

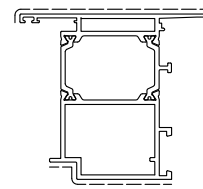

D1220069
kg/m. 1.717
sup. in vista mm. 147
TAPPO D015D125

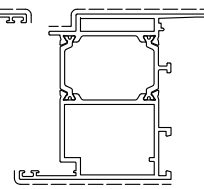

D1220070
kg/m. 1.717
sup. in vista mm. 147.5

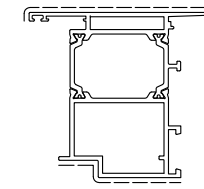

D1220068
kg/m. 1.717
sup. in vista mm. 147
TAPPO D15D125A

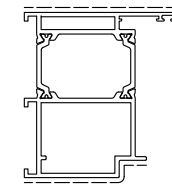

D1220067
kg/m. 1.592
sup. in vista mm. 121

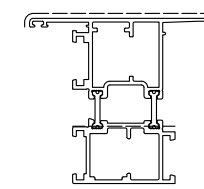

D1211037
kg/m. 1.715
sup. in vista mm. 130

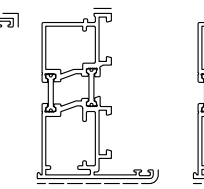

D1211032
kg/m. 1.329
sup. in vista mm. 57

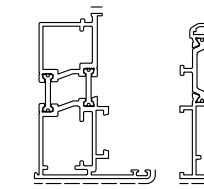

D1211033
kg/m. 1.308
sup. in vista mm. 54

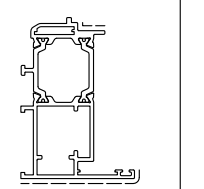

D1211034
kg/m. 1.188
sup. in vista mm. 63

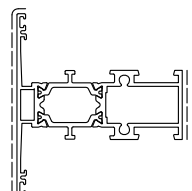

D1211007
kg/m. 1.433
sup. in vista mm. 109

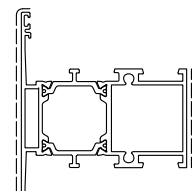

D1210155
kg/m. 1.660
sup. in vista mm. 132

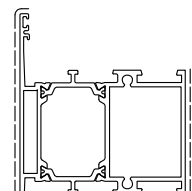

D1211045
kg/m. 1.868
sup. in vista mm. 152

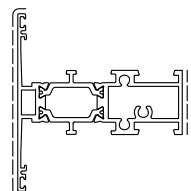

D1210010
kg/m. 1.402
sup. in vista mm. 104

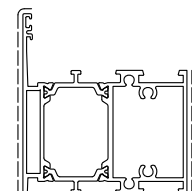

D1210011
kg/m. 1.833
sup. in vista mm. 128

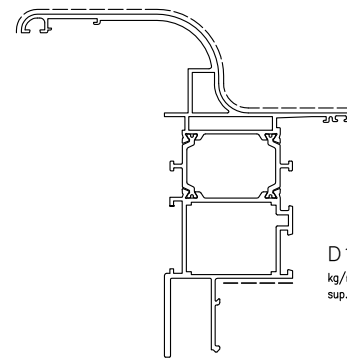

D1220072
kg/m. 2.858
sup. in vista mm. 193

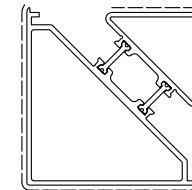

D1210075
kg/m. 2.118
sup. in vista mm. 227



D3210016
kg/m. 0.379
sup. in vista mm. 55

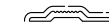

D3220126
kg/m. 0.225
sup. in vista mm. 51

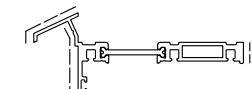

D1211041
kg/m. 0.802
sup. in vista mm. 65



D3290138
kg/m. 0.140
sup. in vista mm. 18



D3091045
kg/m. 0.210
sup. in vista mm. 34
TAPPO SX D4040029
TAPPO DX D4040030

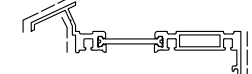

D1211042
kg/m. 0.802
sup. in vista mm. 65

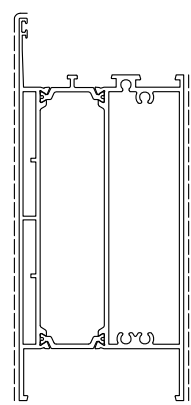

D1220049
kg/m. 3.240
sup. in vista mm. 290

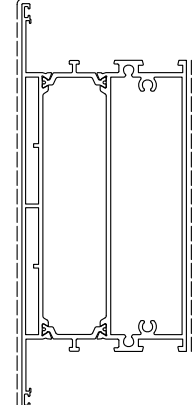

D1220075
kg/m. 3.290
sup. in vista mm. 288

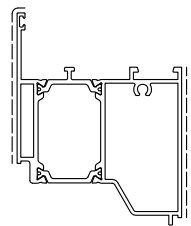

D1211046
kg/m. 1.655
sup. in vista mm. 125

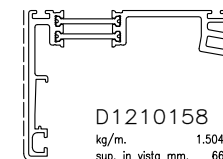

D1210158
kg/m. 1.504
sup. in vista mm. 66



D3290001
kg/m. 0.144
sup. in vista mm. 14

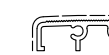

D3220128
kg/m. 0.494
sup. in vista mm. 87

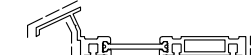

D1211043
kg/m. 0.735
sup. in vista mm. 49

D3210317

kg/m. 0.363
sup. in vista mm.



D3220127
kg/m. 0.464
sup. in vista mm. 40



D3210020
kg/m. 0.516
sup. in vista mm. 39



D3210017
kg/m. 0.119
sup. in vista mm. 31



D1211044
kg/m. 0.768
sup. in vista mm. 13

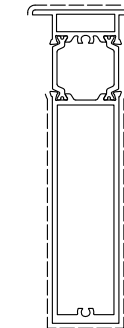

D1211027
kg/m. 2.060
sup. in vista mm. 261

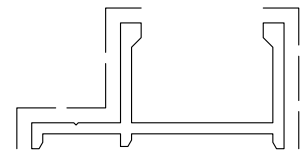

D0008713
sup.vista mm. 52
Kg./m 0.286

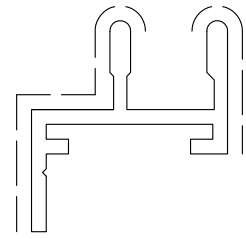

D0007592
sup.vista mm. 53
Kg./m 0.427

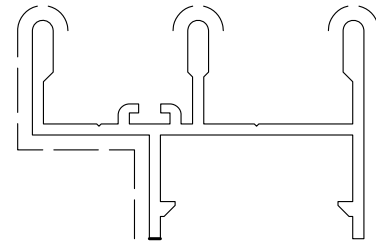

D0009179
sup.vista mm. 85
Kg./m 0.581

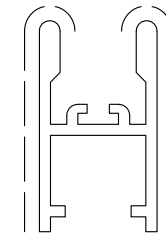

D0008712
sup.vista mm. 63
Kg./m 0.375

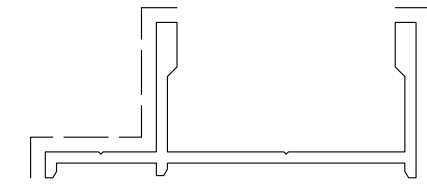

D3290163
sup.vista mm. 63
Kg./m 0.413

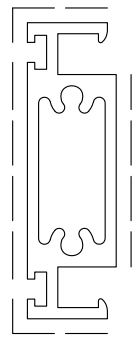

D3290162
sup.vista mm. 82
Kg./m 0.537

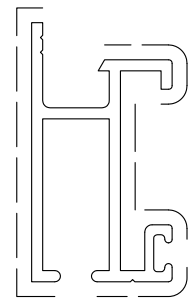

D0009182
sup.vista mm. 93
Kg./m 0.421

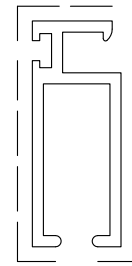

D3290161
sup.vista mm. 70
Kg./m 0.325

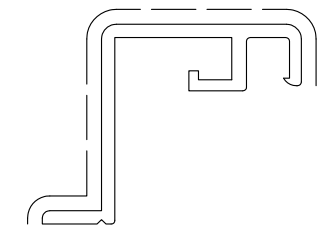

D3290097
sup.vista mm.68.5
Kg./m 0.381

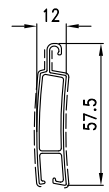

D0016033
sup.vista mm. 117
Kg./m 0.367
TAPPO D0031D23

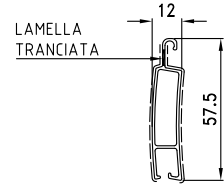

D0031D80
sup.vista mm. 117
Kg./m 0.367
TAPPO D0031D23

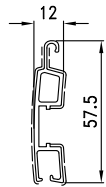

D0016055
sup.vista mm. 109
Kg./m 0.466

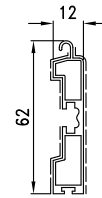

D0016034
sup.vista mm. 125
Kg./m 0.518
CATENACCIO D0031D13

D4210201
SPAZZOLINO 5x5

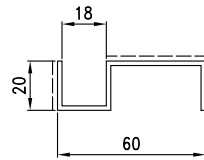

D3290147
sup.vista mm. 60
Kg./m 0.557

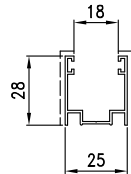

D3290155
sup.vista mm. 63.2
Kg./m 0.278

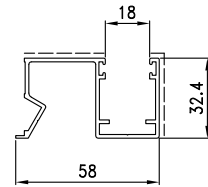

D3290157
sup.vista mm. 71
Kg./m 0.713
TAPPO D4240048

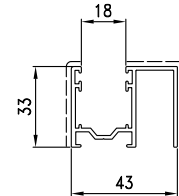

D3290159
sup.vista mm. 93
Kg./m 0.672
TAPPO D4240117

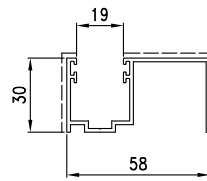

D3290111
sup.vista mm. 98
Kg./m 0.653

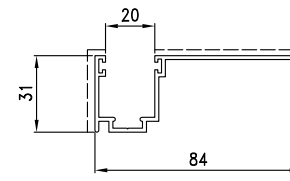

D3290160
sup.vista mm. 134.8
Kg./m 0.815

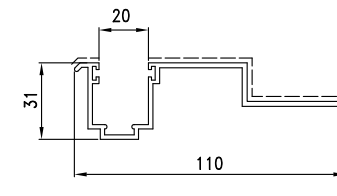

D3290150
sup.vista mm. 122.8
Kg./m 0.993



D0015125
sup.vista mm. 46
Kg./m 0.594

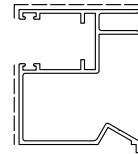

D0015127
sup.vista mm. 86
Kg./m 0.907
TAPPO D4240048

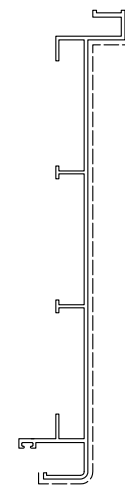

D3290066
sup.vista mm. 224
Kg./m 1.291
TAPPO D6240015

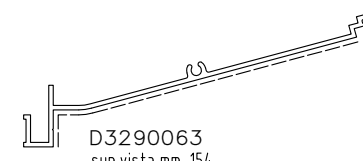

D3290063
sup.vista mm. 154
Kg./m 0.942
TAPPO D0080D04

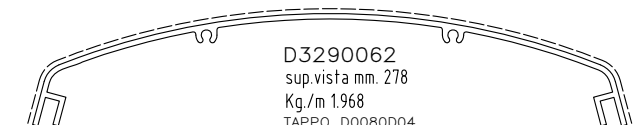

D3290062
sup.vista mm. 278
Kg./m 1.968
TAPPO D0080D04

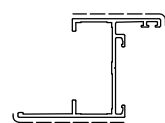

D3210223
sup.vista mm. 84
Kg./m 0.513

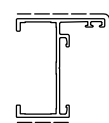

D3210225
sup.vista mm. 60
Kg./m 0.424

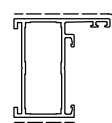

D3210226
sup.vista mm. 67
Kg./m 0.576

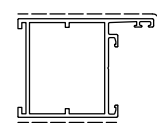

D3210227
sup.vista mm. 100
Kg./m 0.764

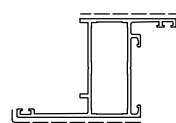

D3210230
sup.vista mm. 96
Kg./m 0.684

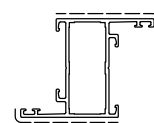

D3210231
sup.vista mm. 86
Kg./m 0.662



D3210235
sup.vista mm. 119
Kg./m 0.894



D3210236
sup.vista mm. 120
Kg./m 0.837

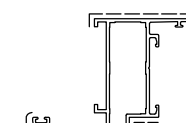

D3210238
sup.vista mm. 104
Kg./m 0.805

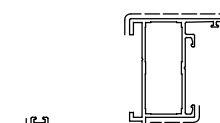

D3210239
sup.vista mm. 138
Kg./m 0.902

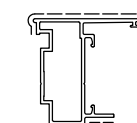

D3210242
sup.vista mm. 74
Kg./m 0.662
TAPPO D0040D08

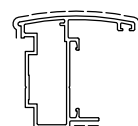

D3210243
sup.vista mm. 73
Kg./m 0.680
TAPPO D0040D18

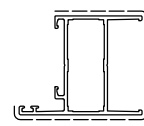

D3220055
sup.vista mm. 92
Kg./m 0.637

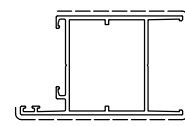

D3220056
sup.vista mm. 124
Kg./m 0.823

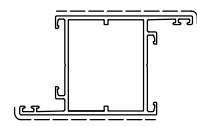

D3210248
sup.vista mm. 118
Kg./m 0.848

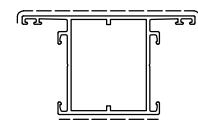

D3210247
sup.vista mm. 118
Kg./m 0.848

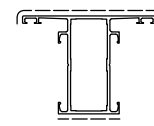

D3210249
sup.vista mm. 86
Kg./m 0.662

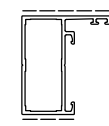

D3210246
sup.vista mm. 60
Kg./m 0.529

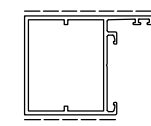

D3210228
sup.vista mm. 93
Kg./m 0.718

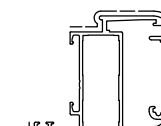

D3210257
sup.vista mm. 120
Kg./m 0.896

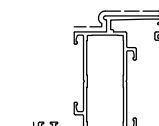

D3210261
sup.vista mm. 99
Kg./m 0.767

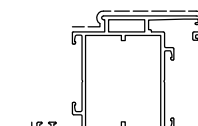

D3210262
sup.vista mm. 131
Kg./m 1.034

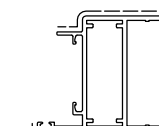

D3220064
sup.vista mm. 116
Kg./m 0.996

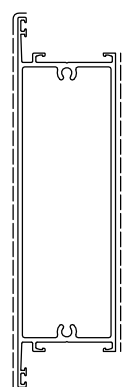

D3220058
sup.vista mm. 278
Kg./m 1.833

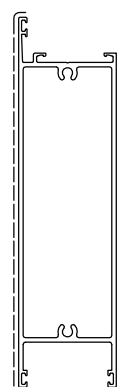

D3220057
sup.vista mm. 290
Kg./m 1.898

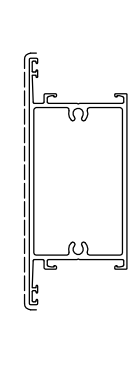

D3210269
sup.vista mm. 178
Kg./m 1.285

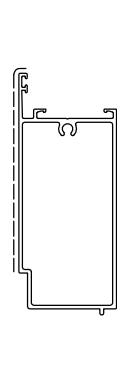

D3210270
sup.vista mm. 165
Kg./m 1.118

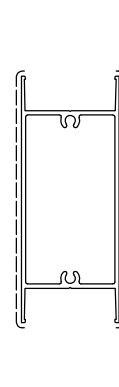

D3220061
sup.vista mm. 207
Kg./m 1.310

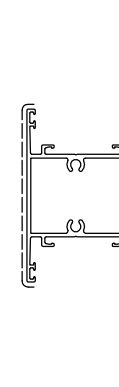

D3210271
sup.vista mm. 118
Kg./m 0.936

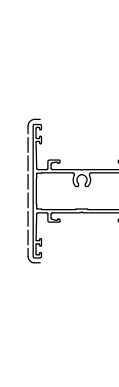

D3210273
sup.vista mm. 86
Kg./m 0.712

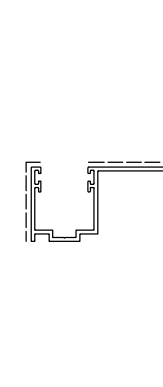

D3290111
sup.vista mm. 95
Kg./m 0.653



D3091045
sup. in vista mm. 34
kg/m. 0.210
TAPPO D4040029 **SX**
TAPPO D4040030 **DX**

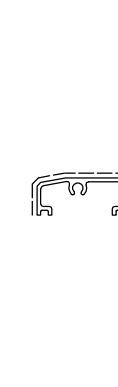

D3220060
sup.vista mm. 64
Kg./m 0.351

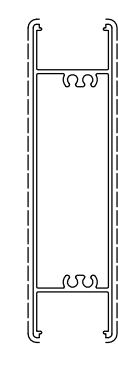

D3210276
sup.vista mm. 262
Kg./m 1.499

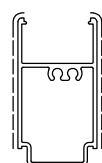

D3210274
sup.vista mm. 110
Kg./m 0.840

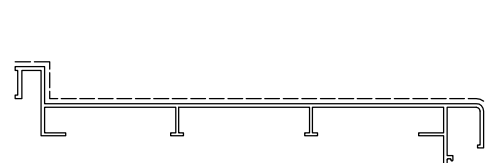

D3290066
sup.vista mm. 224
Kg./m 1.291
TAPPO D6240015

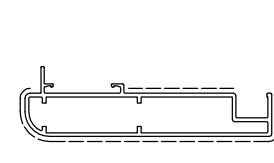

D3290112
sup.vista mm. 162
Kg./m 1.064

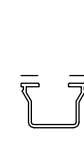

D3210174
sup.vista mm. 15
Kg./m 0.224

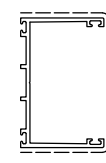

D3210056
sup.vista mm. 74
Kg./m 0.559



D3290002
sup.vista mm. 30
Kg./m 0.122

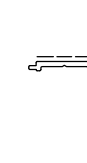

D3210279
sup.vista mm. 23
Kg./m 0.165

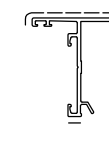

D3220062
sup.vista mm. 47
Kg./m 0.383



D3220063
sup.vista mm. 62
Kg./m 0.310

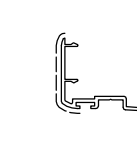

D0026261
sup.vista mm. 35
Kg./m 0.305

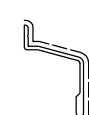

D0019624
sup.vista mm. 39
Kg./m 0.254



D3210277
sup.vista mm. 31
Kg./m 0.338



D0019622
sup.vista mm. 15
Kg./m 0.181



D0019625
sup.vista mm. 53
Kg./m 0.235



D0026260
sup.vista mm. 7.5
Kg./m 0.149

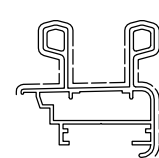

D0026263
sup.vista mm. 204
Kg./m 1.056

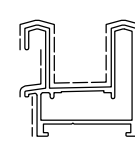

D0019629
sup.vista mm. 182
Kg./m 0.913

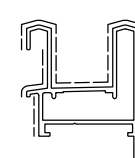

D0019630
sup.vista mm. 205
Kg./m 1.007

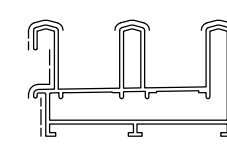

D0023355
sup.vista mm. 52
Kg./m 1.466

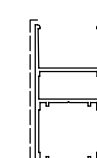

D0023313
sup.vista mm. 138
Kg./m 0.799

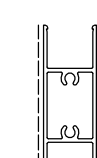

D0023334
sup.vista mm. 130
Kg./m 0.776

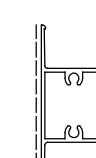

D0026169
sup.vista mm. 136
Kg./m 0.821

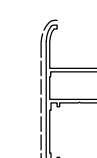

D0026262
sup.vista mm. 142
Kg./m 0.821

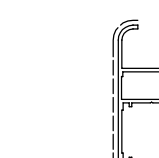

D0023335
sup.vista mm. 75
Kg./m 0.845

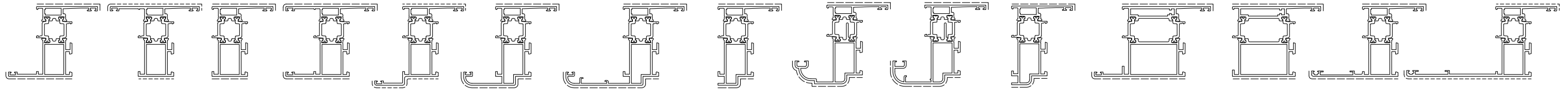

D1210200 kg/m. 1.175 sup. in vista mm. 105	D1210203 kg/m. 1.179 sup. in vista mm. 105	D1210204 kg/m. 1.065 sup. in vista mm. 80	D1210268 kg/m. 1.288 sup. in vista mm. 130	D1210242 kg/m. 1.200 sup. in vista mm. 110	D1210205 kg/m. 1.295 sup. in vista mm. 119	D1210213 kg/m. 1.403 sup. in vista mm. 139	D1210206 kg/m. 1.141 sup. in vista mm. 87	D1B10063 kg/m. 1.307 sup. in vista mm. 123	D1B10079 kg/m. 1.403 sup. in vista mm. 124	D1B10064 kg/m. 1.250 sup. in vista mm. 85	D1210209 kg/m. 1.620 sup. in vista mm. 147	D1210210 kg/m. 1.496 sup. in vista mm. 121	D1210212 kg/m. 1.245 sup. in vista mm. 124	D1210264 kg/m. 1.433 sup. in vista mm. 154
---	---	--	---	---	---	---	--	---	---	--	---	---	---	---

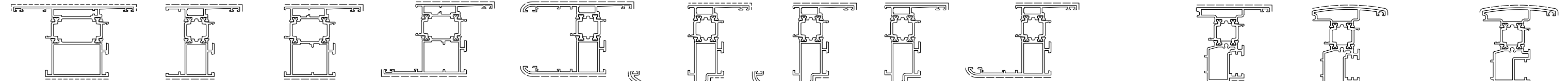

D1B10068 kg/m. 1.642 sup. in vista mm. 150	D1210254 kg/m. 1.163 sup. in vista mm. 102	D1210288 kg/m. 1.296 sup. in vista mm. 104	D1B10069 kg/m. 1.424 sup. in vista mm. 132	D1210269 kg/m. 1.495 sup. in vista mm. 157	D1210278 kg/m. 1.481 sup. in vista mm. 139	D1210207 kg/m. 1.365 sup. in vista mm. 125	D1210208 kg/m. 1.179 sup. in vista mm. 87	D1210267 kg/m. 1.275 sup. in vista mm. 120	D1210234 kg/m. 1.315 sup. in vista mm. 75 TAPPO D4240104	D1210202 kg/m. 1.334 sup. in vista mm. 77 TAPPO D4240095	D1210253 kg/m. 1.292 sup. in vista mm. 77 TAPPO D4240107
---	---	---	---	---	---	---	--	---	--	--	--

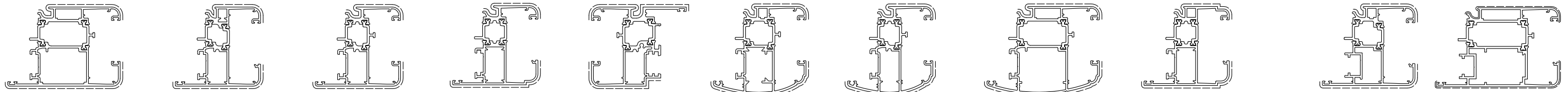

D1210258 kg/m. 1.901 sup. in vista mm. 196	D1210296 kg/m. 1.524 sup. in vista mm. 149	D1210255 kg/m. 1.476 sup. in vista mm. 153	D1210185 kg/m. 1.484 sup. in vista mm. 154	D1210256 kg/m. 1.732 sup. in vista mm. 170 TAPPO EST. D4240096 TAPPO INT. D4240032	D1210279 kg/m. 1.757 sup. in vista mm. 163	D1210265 kg/m. 1.552 sup. in vista mm. 156	D1210266 kg/m. 1.939 sup. in vista mm. 197	D1B10065 kg/m. 1.507 sup. in vista mm. 151	D1210295 kg/m. 1.633 sup. in vista mm. 161	D1210303 kg/m. 2.137 sup. in vista mm. 212
---	---	---	---	---	---	---	---	---	---	---

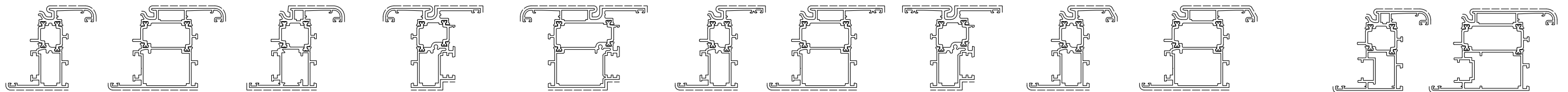



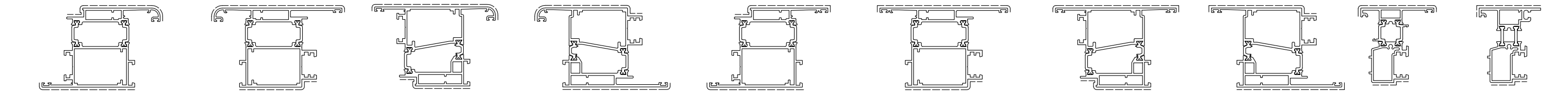



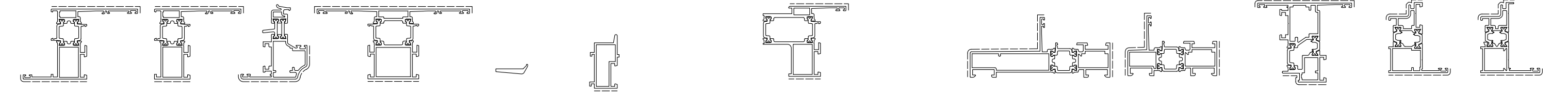



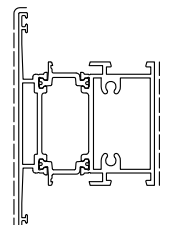
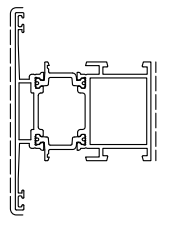
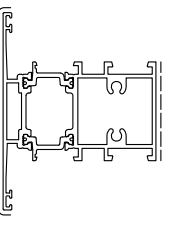
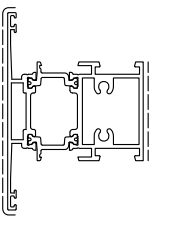
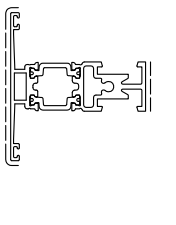
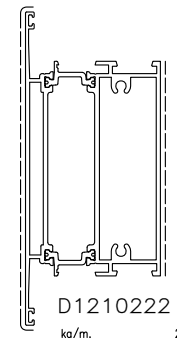
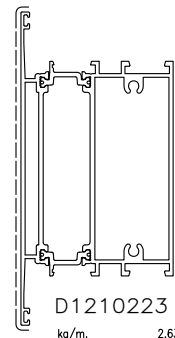
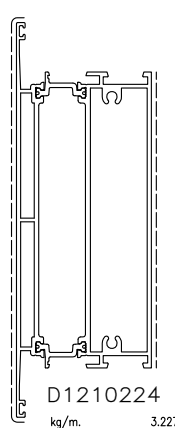
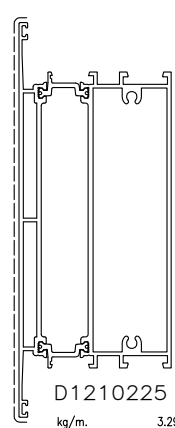
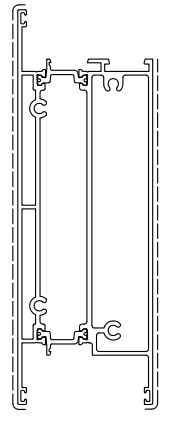
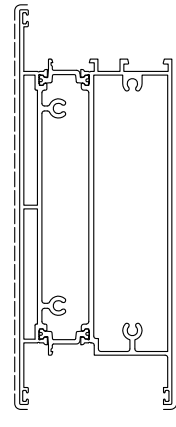
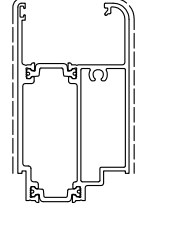
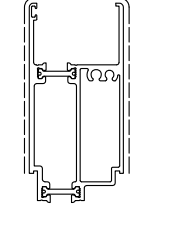
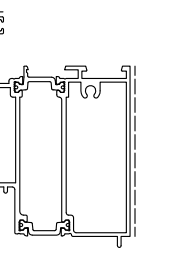
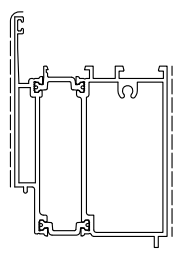
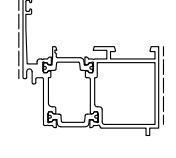
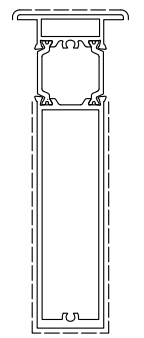
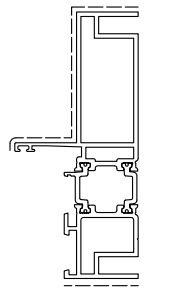
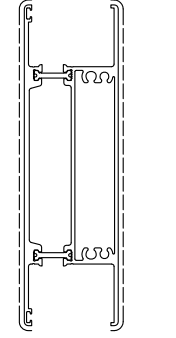
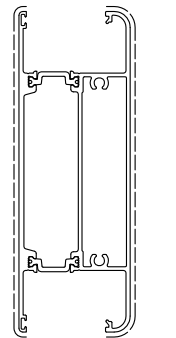
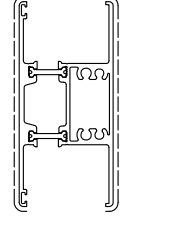
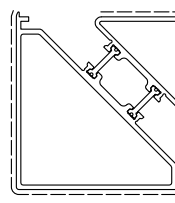
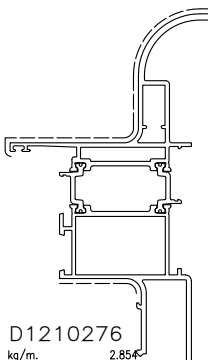
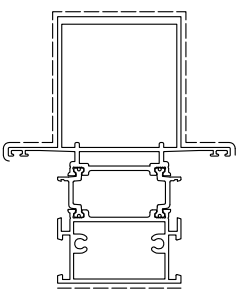
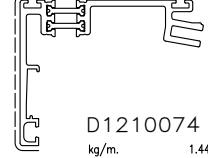
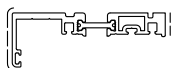
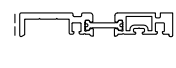
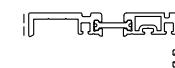

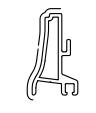

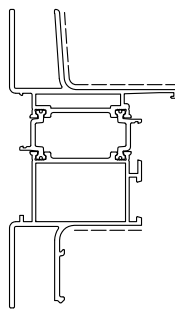
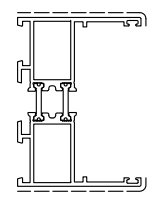
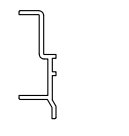
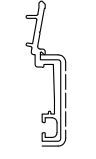

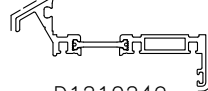

D1210201 kg/m. 1.354 sup. in vista mm. 116	D1210237 kg/m. 1.733 sup. in vista mm. 160	D1210272 kg/m. 1.513 sup. in vista mm. 125	D1210250 kg/m. 1.608 sup. in vista mm. 134 TAPPO EST. D4240096 TAPPO INT. D4240032	D1210270 kg/m. 2.008 sup. in vista mm. 190 TAPPO EST. D4240096 TAPPO INT. D4240032	D1210215 kg/m. 1.317 sup. in vista mm. 112	D1210236 kg/m. 1.698 sup. in vista mm. 156	D1210216 kg/m. 1.566 sup. in vista mm. 129 TAPPO EST. D4240096 TAPPO INT. D4240032	D1210214 kg/m. 1.352 sup. in vista mm. 117	D1210238 kg/m. 1.734 sup. in vista mm. 160	D1210251 kg/m. 1.461 sup. in vista mm. 125	D1210252 kg/m. 1.972 sup. in vista mm. 172
---	---	---	---	---	---	---	---	---	---	---	---

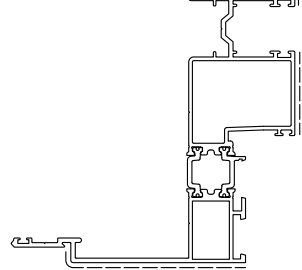
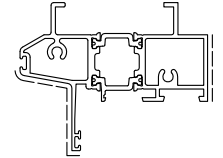
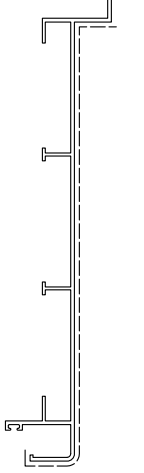

D1220028 kg/m. 1.931 sup. in vista mm. 165	D1220029 kg/m. 2.087 sup. in vista mm. 193 TAPPO EST. D4240158 TAPPO INT. D4240032	D1220030 kg/m. 2.076 sup. in vista mm. 169	D1220031 kg/m. 2.230 sup. in vista mm. 197 TAPPO EST. D4240032 TAPPO INT. D4240158	D1220034 kg/m. 1.896 sup. in vista mm. 161	D1220035 kg/m. 2.056 sup. in vista mm. 189 TAPPO EST. D4240158 TAPPO INT. D4240032	D1220036 kg/m. 2.022 sup. in vista mm. 165	D1220037 kg/m. 2.180 sup. in vista mm. 193 TAPPO EST. D4240032 TAPPO INT. D4240158	D1210235 kg/m. 1.290 sup. in vista mm. 81 TAPPO D4240106	D1220044 kg/m. 1.302 sup. in vista mm. 69 TAPPO D4240106
---	---	---	---	---	---	---	---	--	--

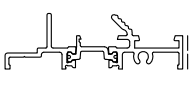

D1210260 kg/m. 1.288 sup. in vista mm. 125	D1210261 kg/m. 1.178 sup. in vista mm. 100	D1210262 kg/m. 1.147 sup. in vista mm. 76	D1210263 kg/m. 1.681 sup. in vista mm. 167	D3210009 kg/m. 0.210 sup. in vista mm. -	D3210312 kg/m. 0.539 sup. in vista mm. 18	D1210211 kg/m. 1.312 sup. in vista mm. 104	D1210302 kg/m. 1.676 sup. in vista mm. 131	D1210286 kg/m. 1.306 sup. in vista mm. 92	D1210301 kg/m. 1.598 sup. in vista mm. 123	D1210293 kg/m. 1.074 sup. in vista mm. 56	D1210294 kg/m. 1.018 sup. in vista mm. 55
---	---	--	---	---	--	---	---	--	---	--	--

 D1210273 kg/m. 1.836 sup. in vista mm. 146	 D1210221 kg/m. 1.459 sup. in vista mm. 126	 D1210220 kg/m. 1.680 sup. in vista mm. 126	 D1210219 kg/m. 1.626 sup. in vista mm. 126	 D1210217 kg/m. 1.218 sup. in vista mm. 86	 D1210222 kg/m. 2.564 sup. in vista mm. 220	 D1210223 kg/m. 2.632 sup. in vista mm. 220	 D1210224 kg/m. 3.227 sup. in vista mm. 286	 D1210225 kg/m. 3.296 sup. in vista mm. 286			
 D1220032 kg/m. 3.428 sup. in vista mm. 309	 D1220043 kg/m. 3.584 sup. in vista mm. 309	 D1B10067 kg/m. 1.531 sup. in vista mm. 148 TAPPO D4240109	 D1211001 kg/m. 1.463 sup. in vista mm. 143 TAPPO D4240109	 D1210229 kg/m. 1.874 sup. in vista mm. 141	 D1210230 kg/m. 2.004 sup. in vista mm. 141	 D1210228 kg/m. 1.136 sup. in vista mm. 69	 D1211027 kg/m. 2.060 sup. in vista mm. 261	 D1210233 kg/m. 1.993 sup. in vista mm. 136	 D1210277 kg/m. 2.195 sup. in vista mm. 269 TAPPO D4240109	 D1B10080 kg/m. 2.262 sup. in vista mm. 278 TAPPO D4240109	 D1210257 kg/m. 1.548 sup. in vista mm. 175 TAPPO D4240109
 D1210075 kg/m. 2.119 sup. in vista mm. 227	 D1210276 kg/m. 2.854 sup. in vista mm. 214	 D1210232 kg/m. 2.657 sup. in vista mm. 252	 D1210074 kg/m. 1.445 sup. in vista mm. 67	 D1210299 kg/m. 0.735 sup. in vista mm. 32	 D1210298 kg/m. 0.677 sup. in vista mm. 18	 D1210300 kg/m. 0.741 sup. in vista mm. 32	 D3290207 kg/m. 0.298 sup. in vista mm. 22 TAPPO D4240155	 D3290208 kg/m. 0.399 sup. in vista mm. 32 TAPPO D4240156	 D0060099 kg/m. 0.270 sup. in vista mm. 17,5		
 D1210291 kg/m. 2.313 sup. in vista mm. 122	 D1210275 kg/m. 1.365 sup. in vista mm. 106	 D3210007 kg/m. 0.321 sup. in vista mm. --	 D3210020 kg/m. 0.516 sup. in vista mm. 39	 D3091045 kg/m. 0.210 sup. in vista mm. 34 TAPPO SX D4040029 TAPPO DX D4040030	 D1210249 kg/m. 0.854 sup. in vista mm. 67	 D3220126 kg/m. 0.226 sup. in vista mm. 52	 D3290001 kg/m. 0.144 sup. in vista mm. 14	 D3290197 kg/m. 0.116 sup. in vista mm. 9	 D1210246 kg/m. 2.186 sup. in vista mm. 150 TAPPO D4240117	 D1210248 kg/m. 1.592 sup. in vista mm. 102	 D3290066 kg/m. 1.290 sup. in vista mm. 222 TAPPO D6240015
 D3290135 kg/m. 0.096 sup. in vista mm. --	 D3290136 kg/m. 0.184 sup. in vista mm. 33	 D3290137 kg/m. 0.178 sup. in vista mm. 31	 D1210297 kg/m. 0.774 sup. in vista mm. 13,5	 D3220132 kg/m. 0.198 sup. in vista mm. --	 D3220016 kg/m. 0.299 sup. in vista mm. 20	 D3290138 kg/m. 0.140 sup. in vista mm. 18	 D3200035 kg/m. 0.340 sup. in vista mm. --				

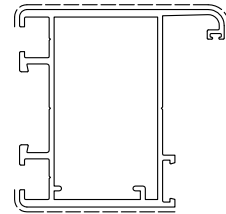

D3220129
sup.vista mm. 167
Kg./m 2.360

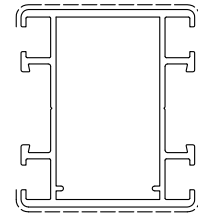

D3220130
sup.vista mm. 164
Kg./m 2.606

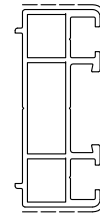

D3220131
sup.vista mm. 74
Kg./m 1.701



D3290051
sup.vista mm. 34
Kg./m 0.313



D3290012
sup.vista mm. --
Kg./m 0.551

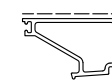

D3290052
sup.vista mm. 59
Kg./m 0.456

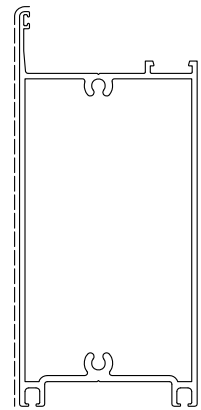

D3220004
sup.vista mm. 303
Kg./m 3.086

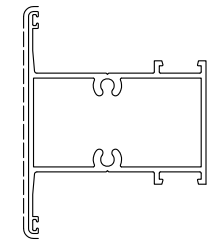

D3220011
sup.vista mm. 146
Kg./m 1.836

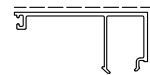

D3290129
sup.vista mm. 74
Kg./m 0.410

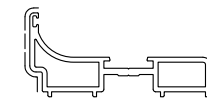

D3220007
sup.vista mm. 55
Kg./m 1.110



D3220006
sup.vista mm. --
Kg./m 0.583



D3290013
sup.vista mm. 47
Kg./m 0.221



D3290011
sup.vista mm. 86
Kg./m 1.304

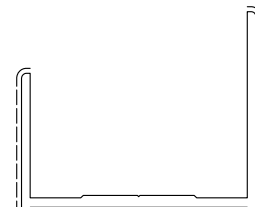

D3290004
sup.vista mm. 140
Kg./m 2.298

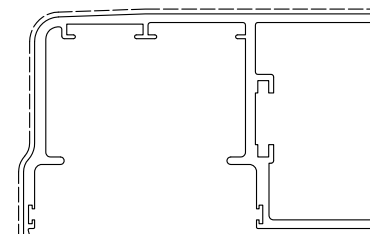

D3220005
sup.vista mm. 277
Kg./m 4.104



D3290009
sup.vista mm. 53
Kg./m 0.578

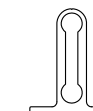

D3290008
sup.vista mm. --
Kg./m 0.929

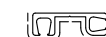

D3290003
sup.vista mm. 56
Kg./m 0.278

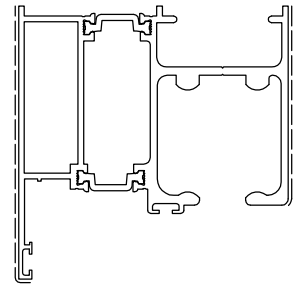

D1250007
Kg/m 2.560
Sup. in vista mm 146

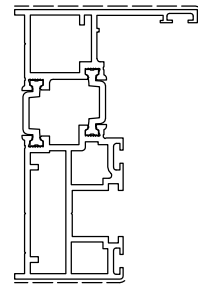

D1250008
Kg/m 1.843
Sup. in vista mm 92

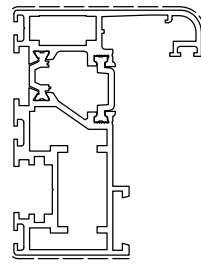

D1250009
Kg/m 1.979
Sup. in vista mm 102

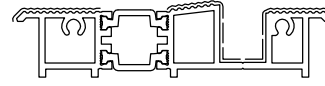

D1250010
Kg/m 1.447
Sup. in vista mm 121

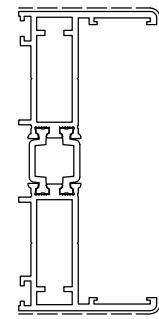

D1250013
Kg/m 1.609
Sup. in vista mm 90

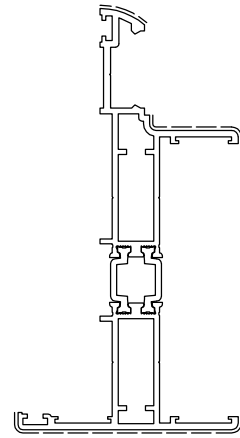

D1250014
Kg/m 2.081
Sup. in vista mm 123

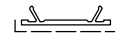

D3290002
Kg/m 0.122
Sup. in vista mm 30



D3250031
Kg/m 0.211
Sup. in vista mm 36

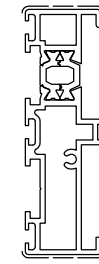

D1250015
Kg/m 1.238
Sup. in vista mm 48
TAPPO D4240276

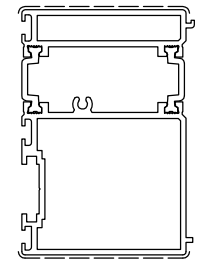

D1250012
Kg/m 1.806
Sup. in vista mm 102
TAPPO D4240275

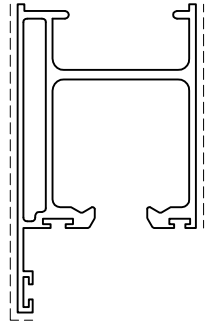

D3250003
kg/m 1.566
sup. in vista mm 146

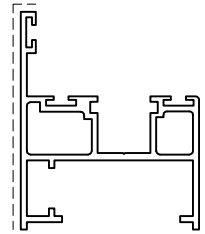

D3250004
kg/m 1.024
sup. in vista mm 98

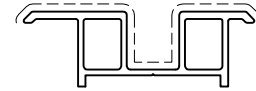

D3250005
kg/m 0.673
sup. in vista mm 92

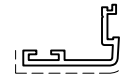

D3250031
kg/m 0.211
sup. in vista mm 36



D3290002
kg/m 0.122
sup. in vista mm 30



D3290001
kg/m 0.144
sup. in vista mm 14

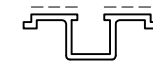

D3290002
kg/m 0.262
sup. in vista mm 25

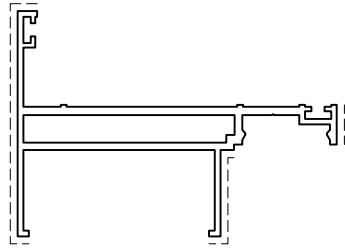

D3250002
kg/m 1.296
sup. in vista mm 108

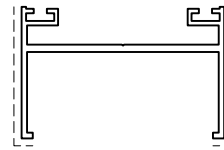

D3250001
kg/m 0.656
sup. in vista mm 76

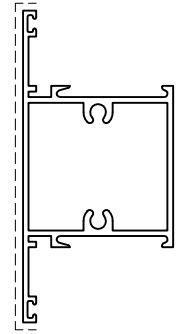

D3250021
kg/m 1.031
sup. in vista mm 133



D3280001
kg/m 0.347
sup. in vista mm 111



D3280002
kg/m 0.448
sup. in vista mm 141



D0050013
kg/m 0.240
sup. in vista mm 111

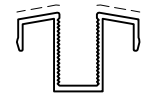

D3280007
kg/m 0.311
sup. in vista mm 21

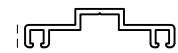

D0019632
kg/m 0.256
sup. in vista mm 12

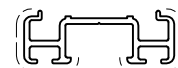

D3250007
kg/m 0.386
sup. in vista mm 44

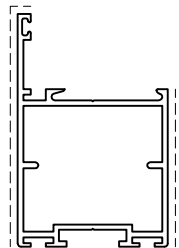

D3250011
kg/m 0.854
sup. in vista mm 108

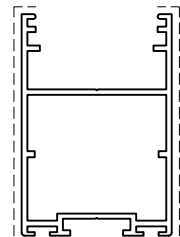

D3250012
kg/m 0.923
sup. in vista mm 126

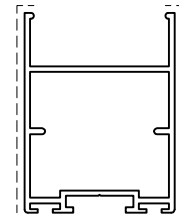

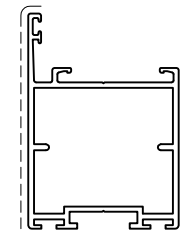

D0019650
kg/m 0.837
sup. in vista mm 106

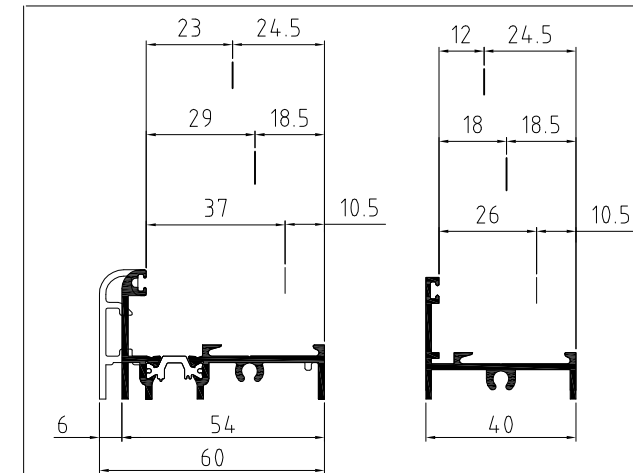

D0019656
kg/m 0.848
sup. in vista mm 105



D3290190 kg/m 0.245 sup. in vista mm 44.5	D3290193 kg/m 0.240 sup. in vista mm 42
D3290189 kg/m 0.246 sup. in vista mm 39.5	D3290192 kg/m 0.235 sup. in vista mm 36
D3290188 kg/m 0.226 sup. in vista mm 30.5	D3290191 kg/m 0.216 sup. in vista mm 28
	

N.B. NON LAVORABILE CON LA
PUNZONATRICE DI SISTEMA.
CERNIERA D6210095
SQUADRETTA D4354000

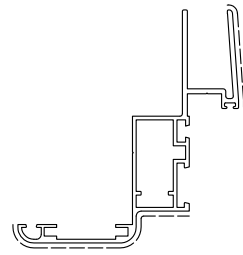

D3220078
sup.vista mm. 124
Kg./m 1.501

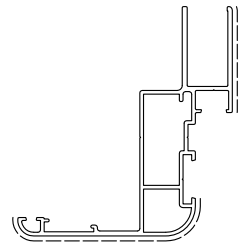

D3220079
sup.vista mm. 130
Kg./m 1.523



D3220081
sup.vista mm. 60
Kg./m 0.392

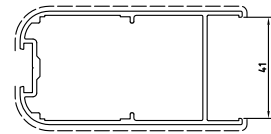

D3220082
sup.vista mm. 204
Kg./m 1.333

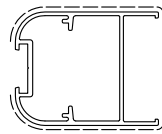

D3220084
sup.vista mm. 140
Kg./m 0.990

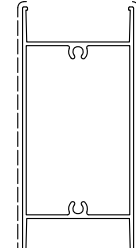

D3220080
sup.vista mm. 205
Kg./m 1.271
TAPPO D0040D20



D3220118
sup.vista mm. 0
Kg./m 0.275

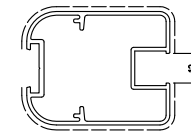

L-IT34642
sup.vista mm. 167
Kg./m 1.064

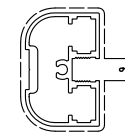

D3220116
sup.vista mm. 135
Kg./m 0.918

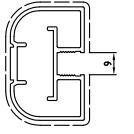

D3B20006
sup.vista mm. 136
Kg./m 0.828

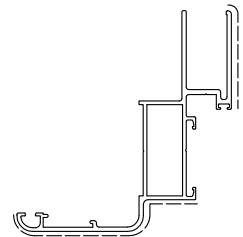

D3220089
sup.vista mm. 126
Kg./m 1.332

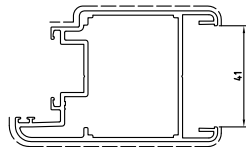

D3220092
sup.vista mm. 171
Kg./m 1.458

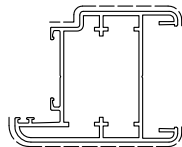

D3220093
sup.vista mm. 137
Kg./m 1.248

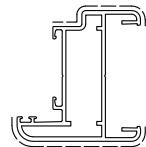

D3220094
sup.vista mm. 105
Kg./m 0.994

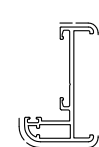

D3220117
sup.vista mm. 52
Kg./m 0.500

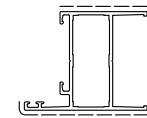

D3220055
sup.vista mm. 92
Kg./m 0.637

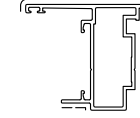

D3210242
sup.vista mm. 74
Kg./m 0.662
TAPPO D0040D08

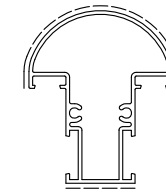

D3220090
sup.vista mm. 124
Kg./m 1.152

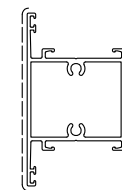

D3210271
sup.vista mm. 118
Kg./m 0.936

N.B. NON LAVORABILE CON LA
PUNZONATRICE DI SISTEMA.
SQUADRETTA D0091A02

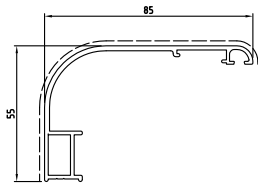

D3220109
sup.vista mm. 132
Kg./m 0.876

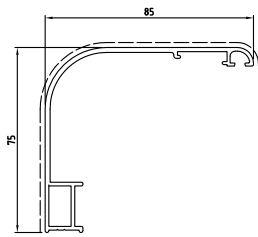

D3220110
sup.vista mm. 153
Kg./m 0.986

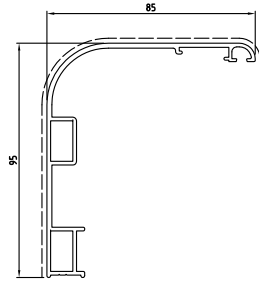

D3220111
sup.vista mm. 173
Kg./m 1.218

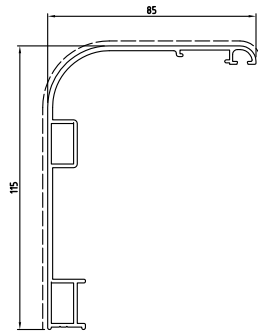

D3220112
sup.vista mm. 192
Kg./m 1.326

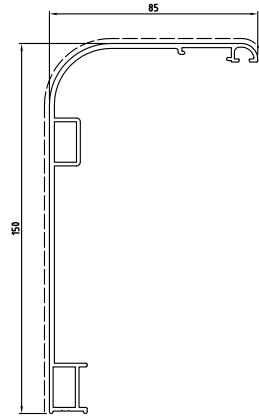

D3220141
sup.vista mm. 227
Kg./m 1.538

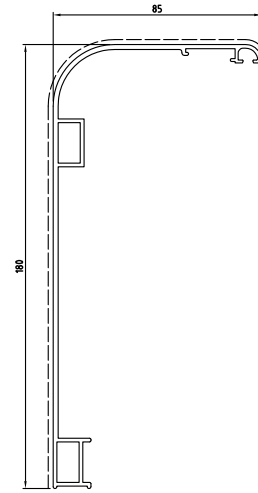

D0034761
sup.vista mm. 258
Kg./m 1.703

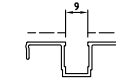

D3220085
sup.vista mm. 31
Kg./m 0.250

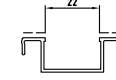

D3220087
sup.vista mm. 18
Kg./m 0.250

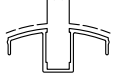

D3220088
sup.vista mm. 32.5
Kg./m 0.308

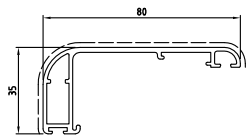

D3220106
sup.vista mm. 114
Kg./m 0.810

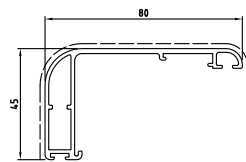

D3220105
sup.vista mm. 124
Kg./m 0.891

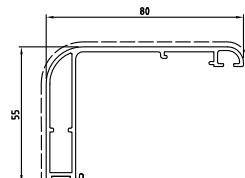

D3220107
sup.vista mm. 134
Kg./m 0.975



D3220108
sup.vista mm. 55
Kg./m 0.581

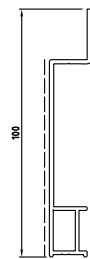

D3220113
sup.vista mm. 80
Kg./m 0.699

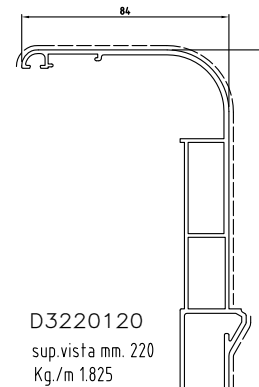

D3220120
sup.vista mm. 220
Kg./m 1.825

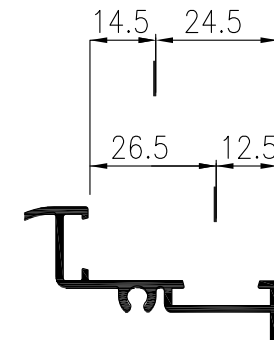

D3220115
sup.vista mm. 39.5
Kg./m 0.221



D3220114
sup.vista mm. 27.5
Kg./m 0.270

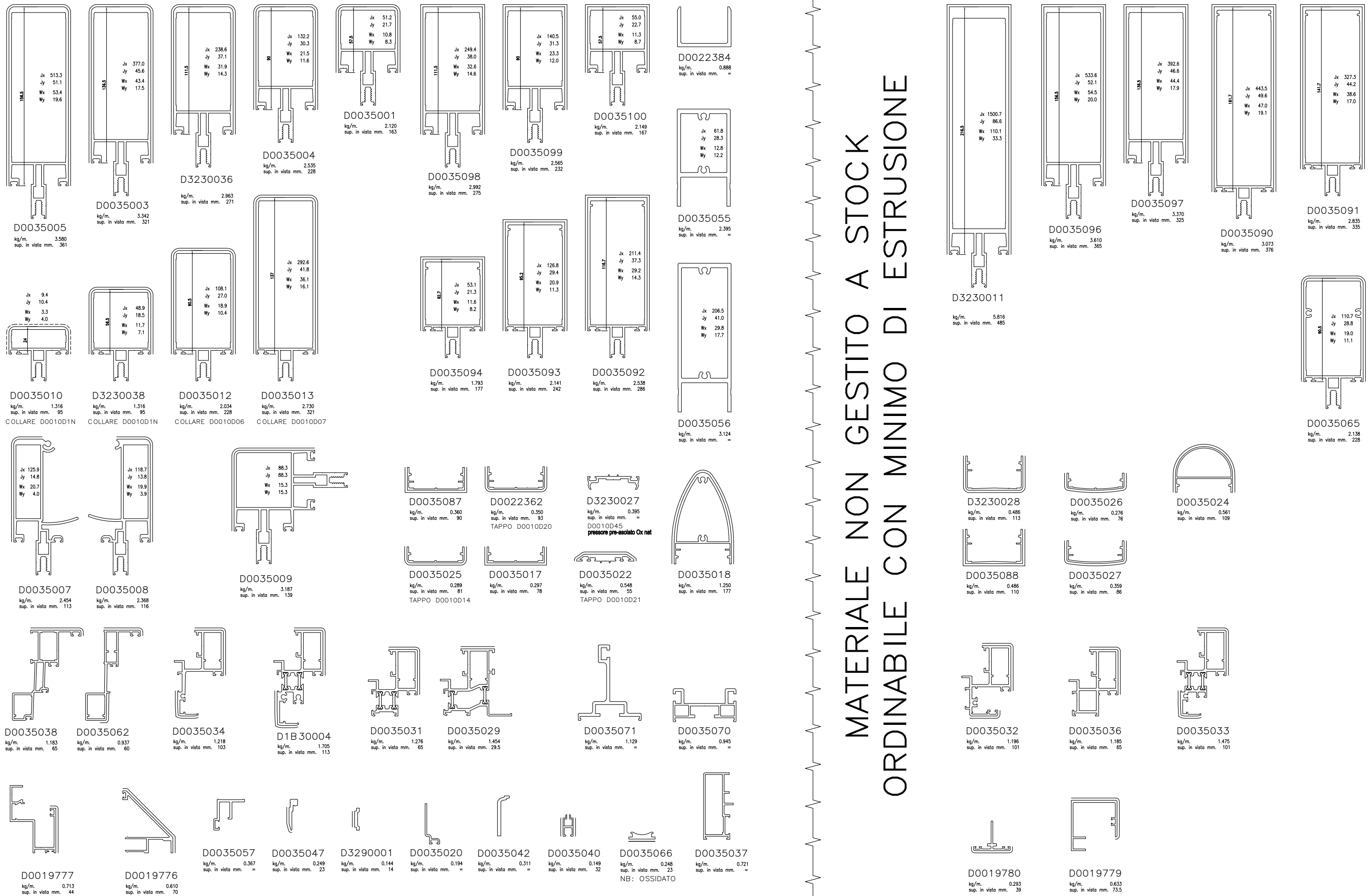

MATERIALE NON GESTITO A STOCK
ORDINABILE CON MINIMO DI ESTRUSIONE

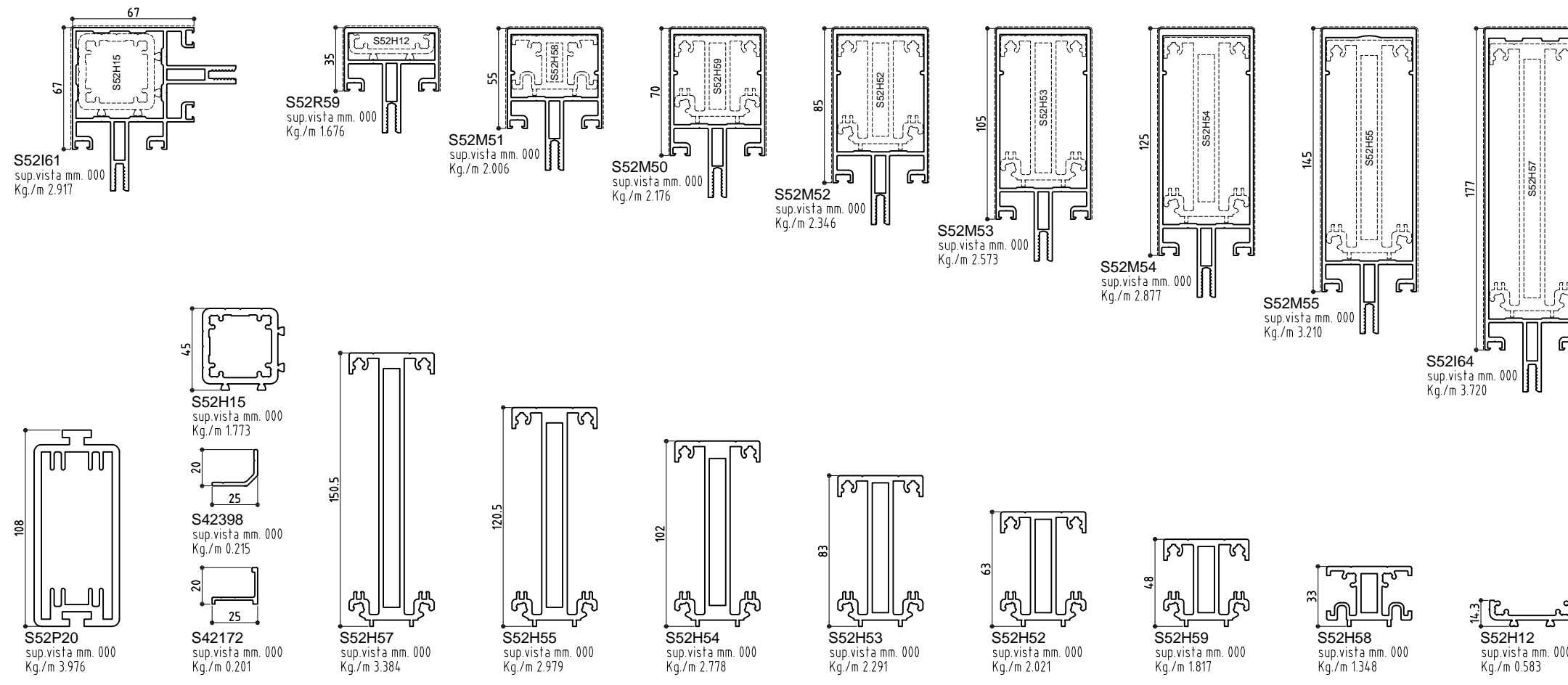
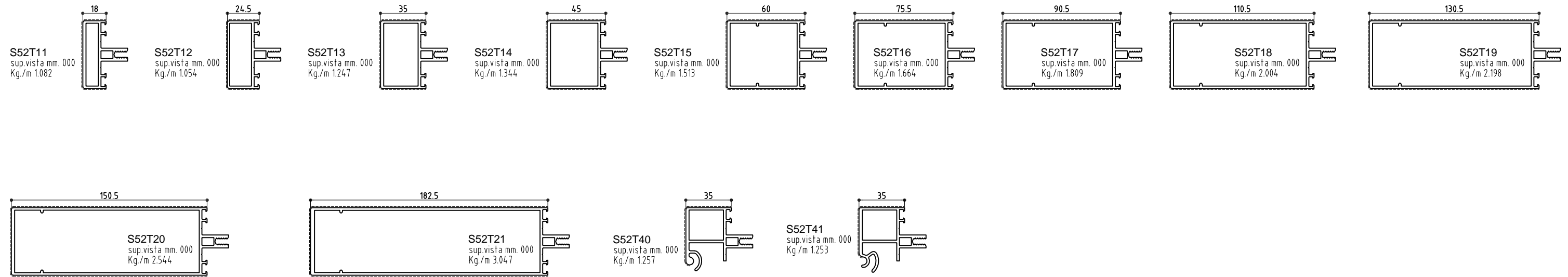

PROFILATI MINIMO ESTRUSIONE

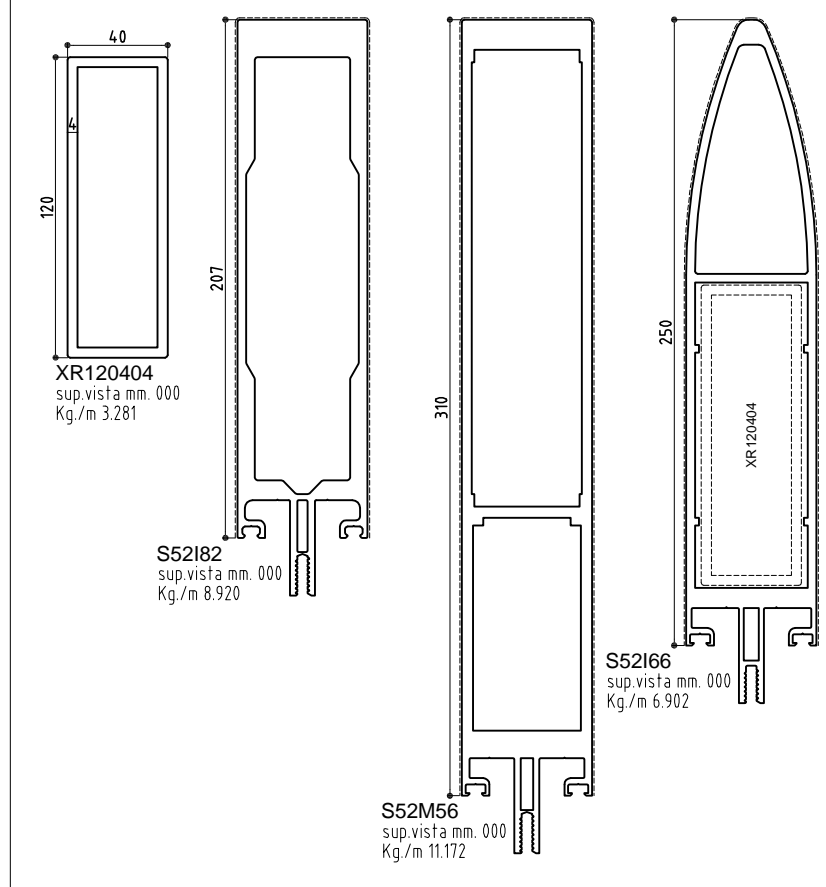

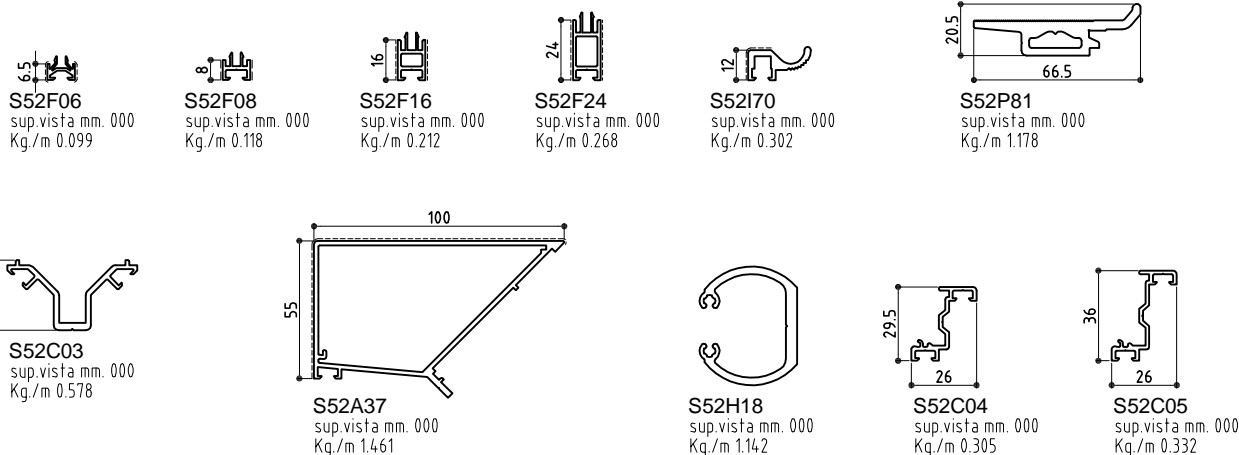
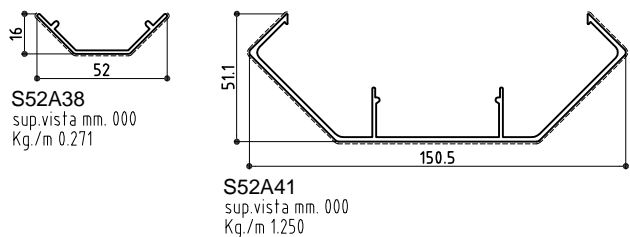
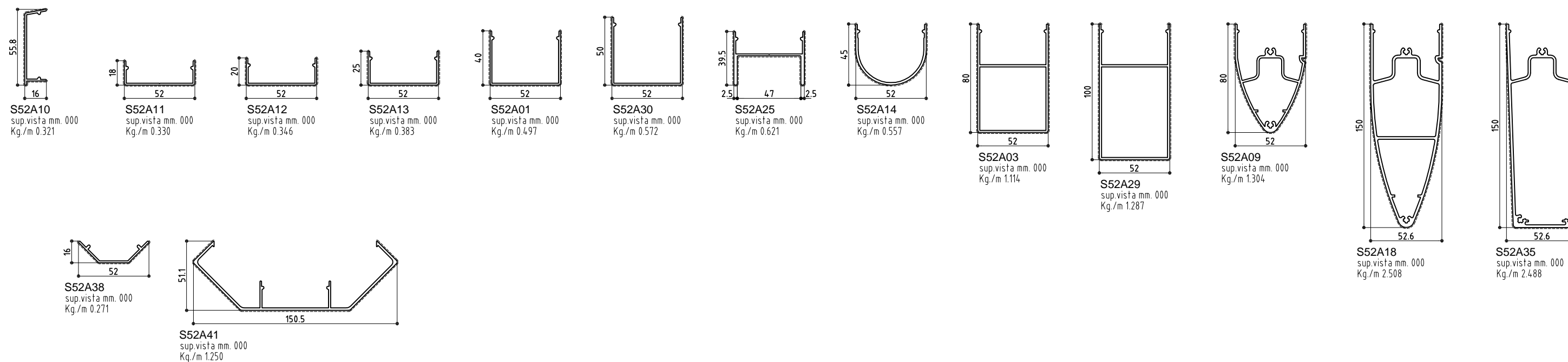
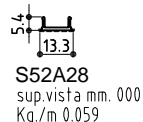
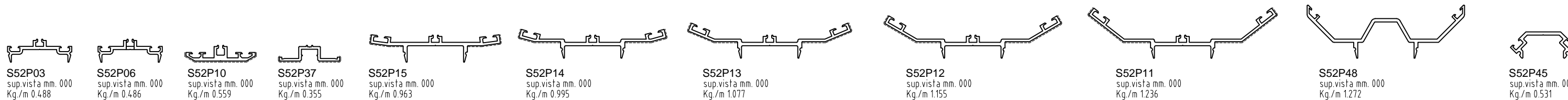

PROFILATI - IT NS

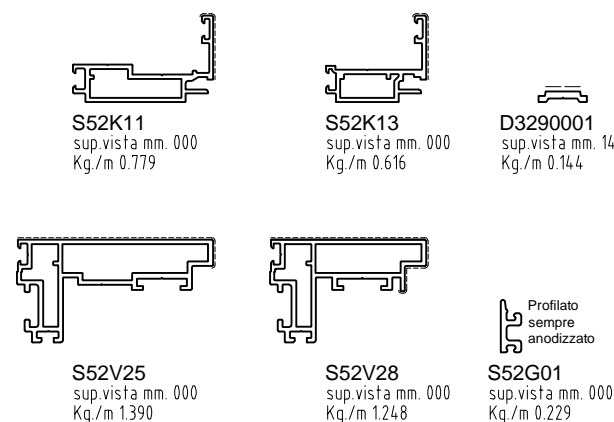

PROFILATI - SGC

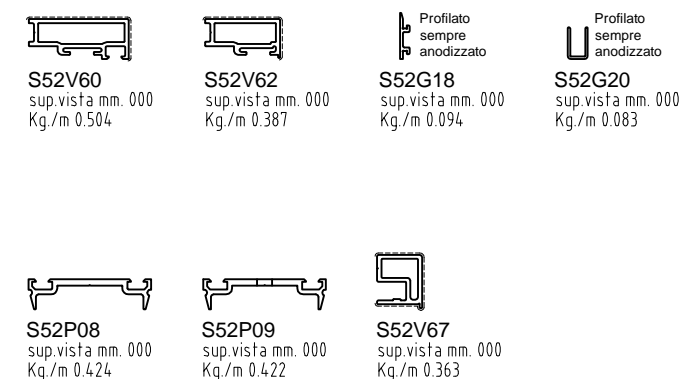

D0027477
sup.vista mm. 20
Kg./m 0.208

D0027470
sup.vista mm. = 0
Kg./m 1.323

D0027480
sup.vista mm. 154
Kg./m 1.590

D3220080
sup.vista mm. 208
Kg./m 1.272
TAPPO D0040D20

D0027478
sup.vista mm. 165
Kg./m 1.328

D0027484
sup.vista mm. 100
Kg./m 1.382

D3220094
sup.vista mm. 105
Kg./m 0.942

D0027488
sup.vista mm. 75
Kg./m 0.656

D3210242
sup.vista mm. 74
Kg./m 0.662
TAPPO D0040D08

D3260061
sup.vista mm. 156
Kg./m 1.331

D0027479
sup.vista mm. 93
Kg./m 0.950

D0027483
sup.vista mm. 109
Kg./m 1.120

D3220093
sup.vista mm. 137
Kg./m 1.172

D0027487
sup.vista mm. 76
Kg./m 0.802

D0027481
sup.vista mm. 60
Kg./m 0.680

D3220085
sup.vista mm. 31
Kg./m 0.250

D3210279
sup.vista mm. 23
Kg./m 0.165

D0027482
sup.vista mm. 81
Kg./m 0.977

D0027475
sup.vista mm. 45
Kg./m 0.840

D0027474
sup.vista mm. 61
Kg./m 0.618

D0027462
sup.vista mm. 100
Kg./m 1.952

D3220087
sup.vista mm. 18
Kg./m 0.250

D0027463
sup.vista mm. 60
Kg./m 0.308

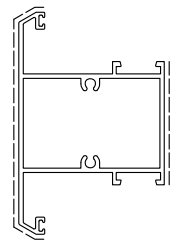

D0024462
sup.vista mm. 154
kg/m 1.496

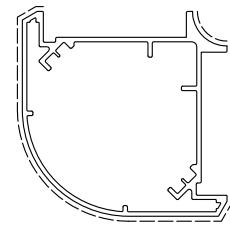

D0024499
sup.vista mm. 174
kg/m 2.031

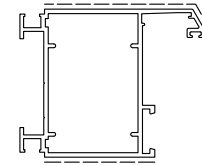

D0024461
sup.vista mm. 118
kg/m 1.372

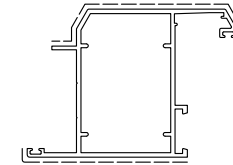

D0024463
sup.vista mm. 163
kg/m 1.336
TAPPO D0013D60

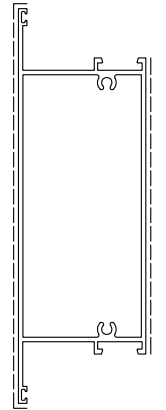

D3210086
sup.vista mm. 287
kg/m 2.036

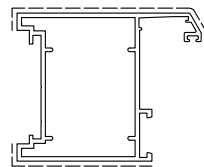

D0060105
sup.vista mm. 151
kg/m 1.415

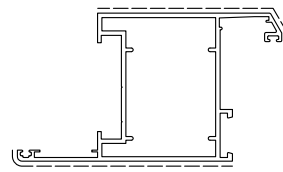

D0024470
sup.vista mm. 195
kg/m 1.587

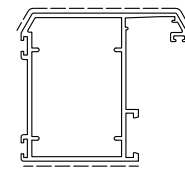

D0024473
sup.vista mm. 126
kg/m 1.266

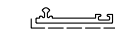

D3290068
sup.vista mm. 36.5
kg/m 0.194

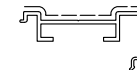

D0024472
sup.vista mm. 74
kg/m 0.429

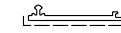

D3290067
sup.vista mm. 46.5
kg/m 0.251

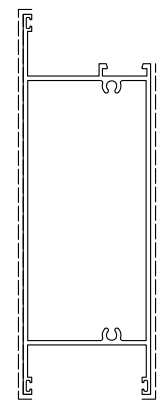

D3220020
sup.vista mm. 298
kg/m 2.014

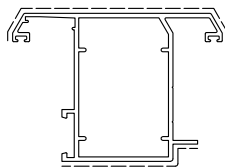

D0024464
sup.vista mm. 163
kg/m 1.401
TAPPO D0013D60

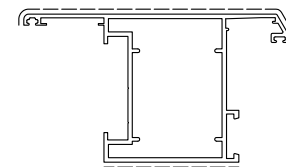

D0024471
sup.vista mm. 195
kg/m 1.587

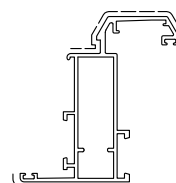

D0024479
sup.vista mm. 113
kg/m 1.042



D0024478
sup.vista mm. 76
kg/m 0.626

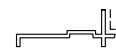

D0024465
sup.vista mm. 14
kg/m 0.227

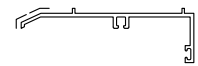

D0024474
sup.vista mm. 35
kg/m 0.424

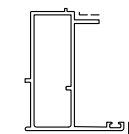

D0024466
sup.vista mm. 57
kg/m 0.640

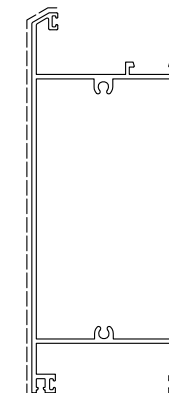

D0024469
sup.vista mm. 292
kg/m 2.238

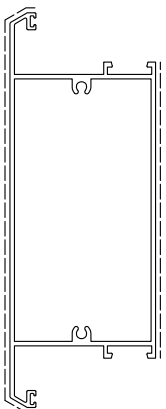

D0024468
sup.vista mm. 294
kg/m 2.218

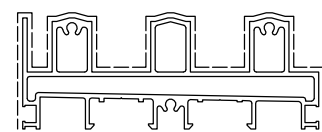

D0015177
sup.vista mm. 30
Kg/m 2.764

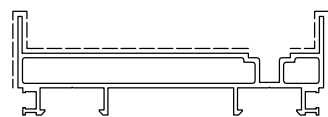

D0015176
sup.vista mm. 95
Kg/m 1.828

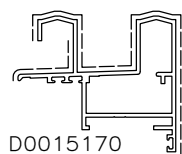

D0015170
sup.vista mm. 95
Kg/m 1.149

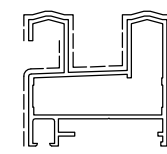

D0015171
sup.vista mm. 211
Kg/m 1.198

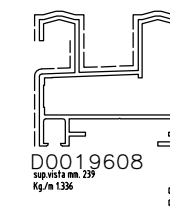

D0019608
sup.vista mm. 239
Kg/m 1.336



D0015175
sup.vista mm. 79
Kg/m 0.269

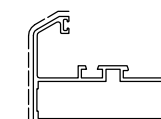

D3210071
sup.vista mm. 93
Kg/m 0.964

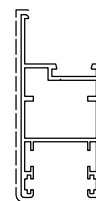

D0015190
sup.vista mm. 140
Kg/m 0.937

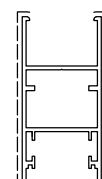

D0015188
sup.vista mm. 154
Kg/m 0.945

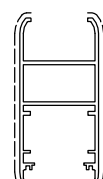

D0026255
sup.vista mm. 151
Kg/m 0.905

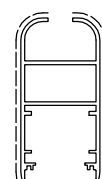

D0026265
sup.vista mm. 158
Kg/m 0.942

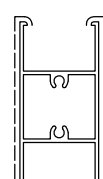

D0019620
sup.vista mm. 158
Kg/m 0.921

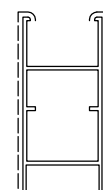

D0007515
sup.vista mm. 165
Kg/m 0.901



D0015182
sup.vista mm. 53
Kg/m 0.246
TAPPO D0011D07



D3290176
sup.vista mm. 14
Kg/m 0.156



D3290161
sup.vista mm. 70
Kg/m 0.325



D0015185
sup.vista mm. 99
Kg/m 0.292
TAPPO D4240274

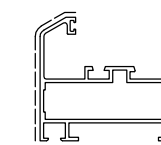

D3210070
sup.vista mm. 117
Kg/m 1.072

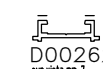

D0026291
sup.vista mm. 7
Kg/m 0.186



D3290001
sup.vista mm. 14
Kg/m 0.144



D3210311
sup.vista mm. 14
Kg/m 0.604

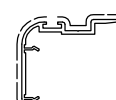

D0026264
sup.vista mm. 73
Kg/m 0.330

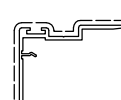

D0015191
sup.vista mm. 83
Kg/m 0.381

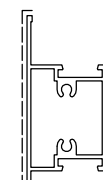

D0015186
sup.vista mm. 130
Kg/m 0.996



D0026267
sup.vista mm. 17
Kg/m 0.254



D0026244
sup.vista mm. 14
Kg/m 0.230



D3290068
sup.vista mm. 37
Kg/m 0.194

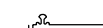

D3290067
sup.vista mm. 47
Kg/m 0.251

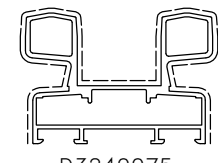

D3240075

kg/m. 1.856
Sup. in vista mm. 290

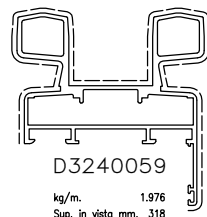

D3240059

kg/m. 1.976
Sup. in vista mm. 318

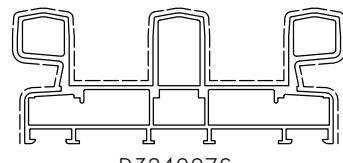

D3240076

kg/m. 2.931
Sup. in vista mm. 400

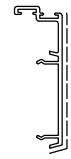

D3240056

kg/m. 0.384
Sup. in vista mm. --

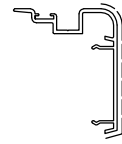

D3240064

kg/m. 0.497
Sup. in vista mm. 65

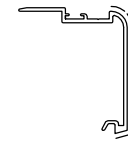

D3290174

kg/m. 0.448
Sup. in vista mm. 57

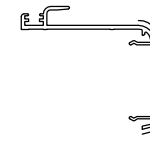

D3240061

kg/m. 0.527
Sup. in vista mm. 50

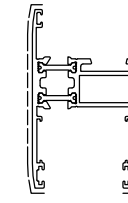

D1240022

kg/m. 1.256
Sup. in vista mm. 126

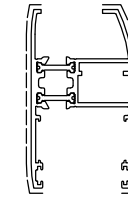

D1240023

kg/m. 1.329
Sup. in vista mm. 153

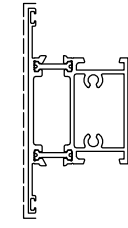

D1240026

kg/m. 1.356
Sup. in vista mm. 126

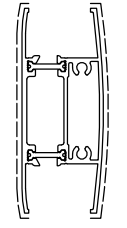

D1240027

kg/m. 1.411
Sup. in vista mm. 166

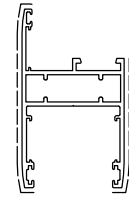

D3240069

kg/m. 1.072
Sup. in vista mm. 134

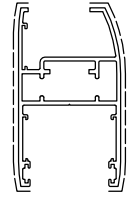

D3240070

kg/m. 1.180
Sup. in vista mm. 162

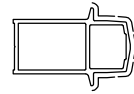

D3240065

kg/m. 0.643
Sup. in vista mm. 58



D3240055

kg/m. 0.273
Sup. in vista mm. 42



D3240054

kg/m. 0.200
Sup. in vista mm. 27

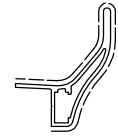

D3290172

kg/m. 0.524
Sup. in vista mm. 119

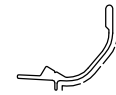

D3290170

kg/m. 0.338
Sup. in vista mm. 49



D3290161

kg/m. 0.325
Sup. in vista mm. 70



D3290162

kg/m. 0.527
Sup. in vista mm. 81



D3290169

kg/m. 0.355
Sup. in vista mm. 58



D0034127

kg/m. 0.451
Sup. in vista mm. --

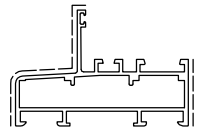

D3240073

kg/m. 1.123
Sup. in vista mm. 99



D3240009

kg/m. 0.251
Sup. in vista mm. 16



D3210314

kg/m. 0.235
Sup. in vista mm. 30.5



D3240057

kg/m. 0.278
Sup. in vista mm. --



D3290002

kg/m. 0.122
Sup. in vista mm. 30

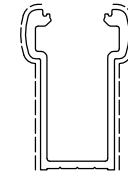

D3290167

kg/m. 1.450
Sup. in vista mm. 146

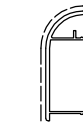

D3290125

kg/m. 0.302
Sup. in vista mm. 59

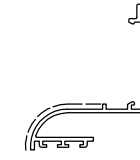

D3290126

kg/m. 0.626
Sup. in vista mm. 39

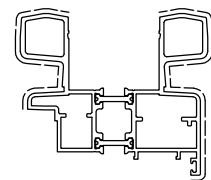

D1240030

kg/m. 1.964
Sup. in vista mm. 199

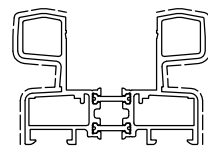

D1240019

kg/m. 1.980
Sup. in vista mm. 196

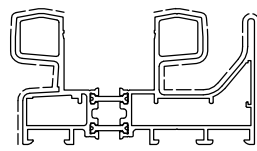

D1240017

kg/m. 2.450
Sup. in vista mm. 273

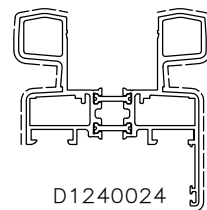

D1240024

kg/m. 2.102
Sup. in vista mm. 228

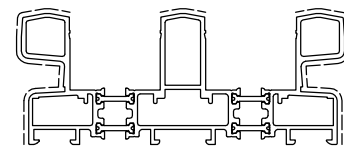

D1240018

kg/m. 3.223
Sup. in vista mm. 214

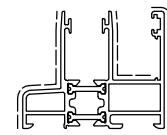

D1240014

kg/m. 1.330
Sup. in vista mm. 160

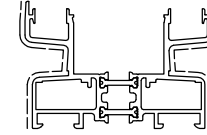

D1240015

kg/m. 1.842
Sup. in vista mm. 160

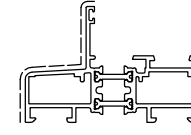

D1240020

kg/m. 1.324
Sup. in vista mm. 99

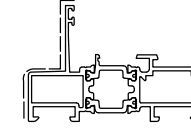

D1210286

kg/m. 1.306
Sup. in vista mm. 92

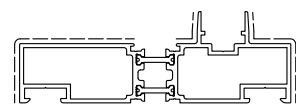

D1240047
sup.vista mm. 117
Kg./m 1.672

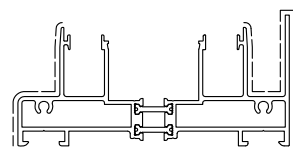

D1240050
sup.vista mm. 196
Kg./m 2.168
TAPPO DOOSLD01

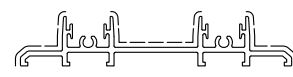

D3240086
sup.vista mm. 132
Kg./m 1.148

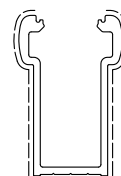

D3290167
sup.vista mm. 146
Kg./m 1.450



D3290002
sup.vista mm. 30
Kg./m 0.122



D3290169
sup.vista mm. 58
Kg./m 0.355

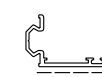

D3210314
sup.vista mm. 31
Kg./m 0.235



D3290001
sup.vista mm. 14
Kg./m 0.144



D3240079
sup.vista mm. 12
Kg./m 0.098



D3240091
sup.vista mm. 13
Kg./m 0.408

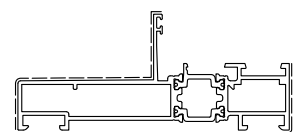

D1210302
sup.vista mm. 131
Kg./m 1.676

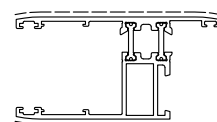

D1240052
sup.vista mm. 146
Kg./m 1.361

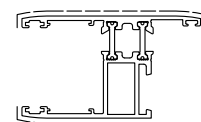

D1240022
sup.vista mm. 126
Kg./m 1.256

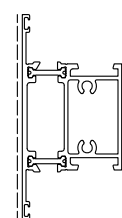

D1240026
sup.vista mm. 126
Kg./m 1.356

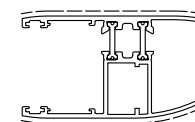

D1240023
sup.vista mm. 153
Kg./m 1.329

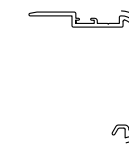

D3290174
kg/m. 0.448
Sup. in vista mm. 57

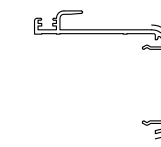

D3240061
kg/m. 0.527
Sup. in vista mm. 50



D0034127
sup.vista mm. =
Kg./m 0.451



D3240057
sup.vista mm. =
Kg./m 0.278

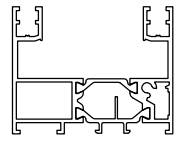

D1074001
kg/m. 1.520
sup. in vista mm. 140

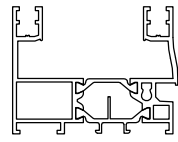

D1074002
kg/m. 1.528
sup. in vista mm. 157

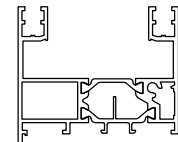

D1074003
kg/m. 1.649
sup. in vista mm. 167

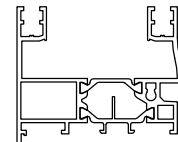

D1074004
kg/m. 1.662
sup. in vista mm. 184

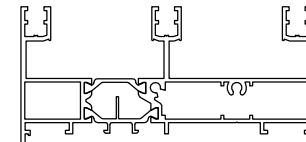

D1074005
kg/m. 2.447
sup. in vista mm. 199

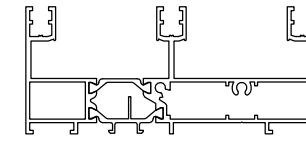

D1074006
kg/m. 2.314
sup. in vista mm. 172

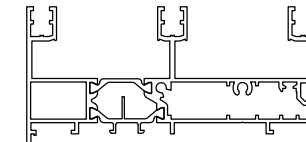

D1074007
kg/m. 2.524
sup. in vista mm. 302

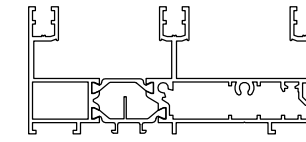

D1074000
kg/m. 2.391
sup. in vista mm. 276

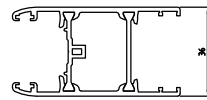

D1074051
kg/m. 1.077
sup. in vista mm. 151

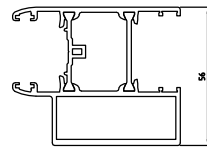

D1074052
kg/m. 1.625
sup. in vista mm. 190
TAPPO D4074006

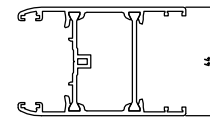

D1074053
kg/m. 1.114
sup. in vista mm. 151

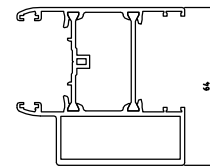

D1074054
kg/m. 1.661
sup. in vista mm. 190
TAPPO D4074006

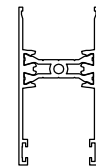

D1074076
kg/m. 0.952
sup. in vista mm. 212

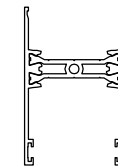

D1074078
kg/m. 0.988
sup. in vista mm. 142

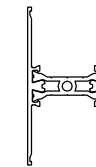

D1074077
kg/m. 0.893
sup. in vista mm. 132

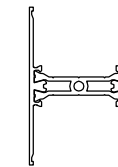

D1074079
kg/m. 0.929
sup. in vista mm. 132

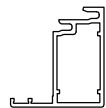

D3074001
kg/m. 0.659
sup. in vista mm. 82

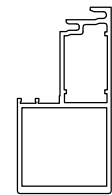

D3074002
kg/m. 1.304
sup. in vista mm. 152
TAPPO D4074007

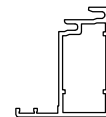

D3074003
kg/m. 0.695
sup. in vista mm. 86

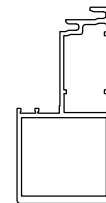

D3074004
kg/m. 1.341
sup. in vista mm. 154
TAPPO D4074007

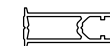

D3074029
kg/m. 0.432
sup. in vista mm. 42
TAPPO D4074011



D3074026
kg/m. 0.306
sup. in vista mm. 90
TAPPO D4074008



D3074005
kg/m. 0.361
sup. in vista mm. 108
NO TAPPO
GIRA SU 4 LATI
PER ZANZARIERA



D3074027
kg/m. 0.1
sup. in vista mm. 20



D3074030
kg/m. 0.188
sup. in vista mm. 38



D3074028
kg/m. 0.106
sup. in vista mm. 9



D4074020
kg/m. 0.25
sup. in vista mm. 9



D1074101
kg/m. 0.883
sup. in vista mm. 51

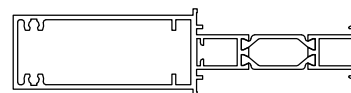

D1074102
kg/m. 1.964
sup. in vista mm. 206



D4074001
kg/m. 0.247
sup. in vista mm. 20



D4074002
kg/m. 0.225
sup. in vista mm. 18



D4074003
kg/m. 0.149
sup. in vista mm. 0.66



D4074004
kg/m. 0.090
sup. in vista mm. 37

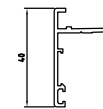

D3074007
kg/m. 0.325
sup. in vista mm. 49
CLIP D4280027

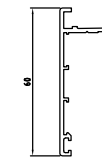

D3074006
kg/m. 0.416
sup. in vista mm. 69
CLIP D4280027

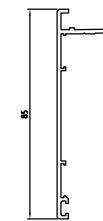

D3074009
kg/m. 0.517
sup. in vista mm. 94
CLIP D4280027

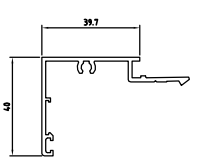

D3074008
kg/m. 0.549
sup. in vista mm. 84
CLIP D4280027

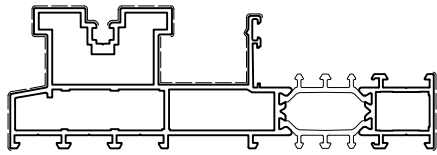

SC9K010
sup.vista mm. 000
Kg./m 3.225

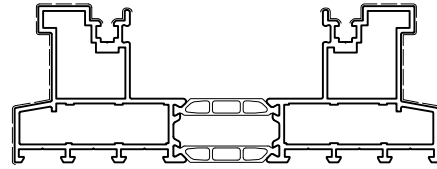

SC9K020
sup.vista mm. 000
Kg./m 3.527

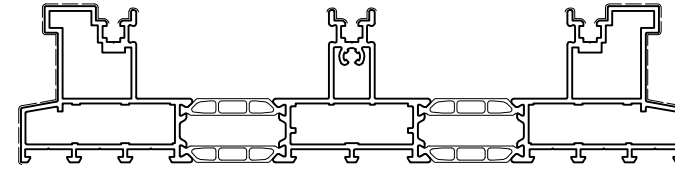

SC9K030
sup.vista mm. 000
Kg./m 5.192



SC 9A010
sup.vista mm. 000
Kg./m 0.733

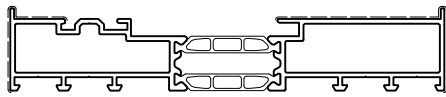

SC 9K 121
sup.vista mm. 000
Kg./m 2.373

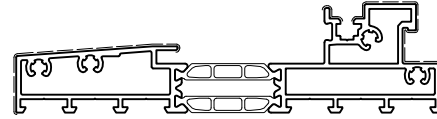

SC 9K 100
sup.vista mm. 000
Kg./m 2.954

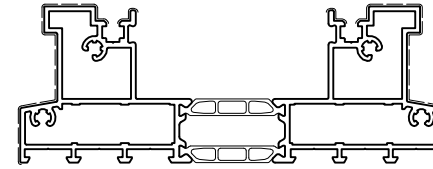

SC9K120
sup.vista mm. 000
Kg./m 3.681

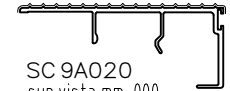

SC 9A020
sup.vista mm. 000
Kg./m 0.605

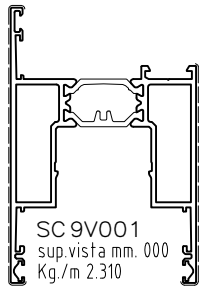

SC 9V001
sup.vista mm. 000
Kg./m 2.310

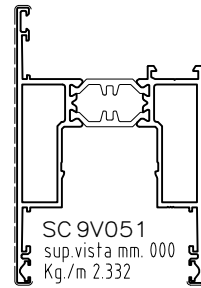

SC 9V051
sup.vista mm. 000
Kg./m 2.332

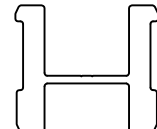

SC 9C 001
sup.vista mm. 000
Kg./m 2.621

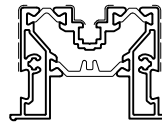

SC 9C 002
sup.vista mm. 000
Kg./m 1.645

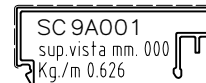

SC 9A001
sup.vista mm. 000
Kg./m 0.626

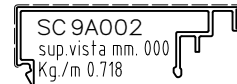

SC 9A002
sup.vista mm. 000
Kg./m 0.718



SC 9A004
sup.vista mm. 000
Kg./m 0.299



SC 9A003
sup.vista mm. 000
Kg./m 0.156



S52A28
sup.vista mm. 000
Kg./m 0.059



SC 9A101
sup.vista mm. 000
Kg./m 0.528

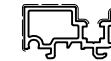

SC 9A100
sup.vista mm. 000
Kg./m 0.505



SZ9C 005
sup.vista mm. 000
Kg./m 0.315

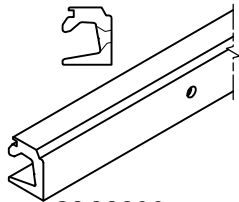

SC02206
sup.vista mm. 000
Kg./m 0.000

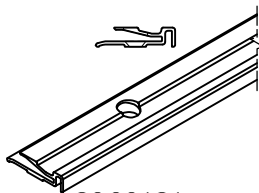

SC02181
sup.vista mm. 000
Kg./m 0.215

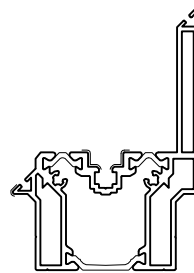

SC 9C 003
sup.vista mm. 000
Kg./m 2.416



SZ9C 030
sup.vista mm. 000
Kg./m 0.130



SZ9A016
sup.vista mm. 000
Kg./m 0.233



SC01103

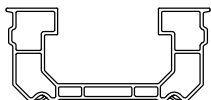

SKU2028

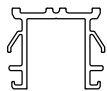

SKU2027



SKU2029



S215008



SKU2035

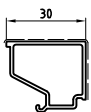

SGC2330
sup.vista mm. 000
Kg./m 0.341

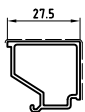

SGC2327
sup.vista mm. 000
Kg./m 0.327

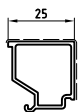

SGC2325
sup.vista mm. 000
Kg./m 0.312

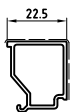

SGC2322
sup.vista mm. 000
Kg./m 0.298



SGC2320
sup.vista mm. 000
Kg./m 0.286



SGC2317
sup.vista mm. 000
Kg./m 0.275



SGC2315
sup.vista mm. 000
Kg./m 0.267



SGC2312
sup.vista mm. 000
Kg./m 0.262



SGC2310
sup.vista mm. 000
Kg./m 0.259



SGC0307
sup.vista mm. 000
Kg./m 0.236



SGC0303
sup.vista mm. 000
Kg./m 0.187



SCO1103

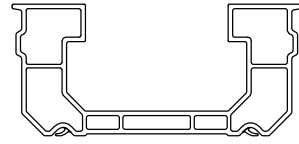

SKU2028

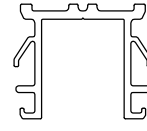

SKU2027

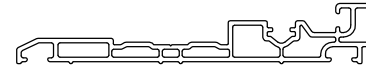

SKU2029



S215008

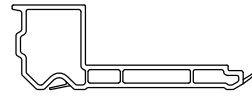

SKU2035

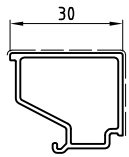

SGC 2330
sup.vista mm. 000
Kg./m 0.341

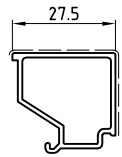

SGC 2327
sup.vista mm. 000
Kg./m 0.327

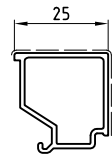

SGC 2325
sup.vista mm. 000
Kg./m 0.312

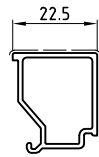

SGC 2322
sup.vista mm. 000
Kg./m 0.298



SGC 2320
sup.vista mm. 000
Kg./m 0.286



SGC 2317
sup.vista mm. 000
Kg./m 0.275



SGC 2315
sup.vista mm. 000
Kg./m 0.267



SGC 2312
sup.vista mm. 000
Kg./m 0.262



SGC 2310
sup.vista mm. 000
Kg./m 0.259



SGC 0307
sup.vista mm. 000
Kg./m 0.236

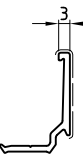

SGC 0303
sup.vista mm. 000
Kg./m 0.187

D3290094 Lg 6500
kg/m. 0.285
sup. in vista mm. 39

D4280027

D1240009 Lg 6650
kg/m. 2.955
sup. in vista mm. 378
TAPPO D4220025

D1240013 Lg 6650
kg/m. 1.953
sup. in vista mm. 158

D3290125 Lg 6500
kg/m. 0.302
sup. in vista mm. 59

D3240055 Lg 6500
kg/m. 0.273
sup. in vista mm. 42
27435

D4210066

D3240052 Lg 6650
kg/m. 0.33
sup. in vista mm. 62

D3240051 Lg 6650
kg/m. 0.44
sup. in vista mm. 74

D3240048 Lg 6650
kg/m. 0.52
sup. in vista mm. 102

D1240012 Lg 6650
kg/m. 1.995
sup. in vista mm. 154

D3290126 Lg 6500
kg/m. 0.626
sup. in vista mm. 39

D3240056 Lg 6500
kg/m. 0.384

D1240010 Lg 6650
kg/m. 2.247
sup. in vista mm. 266

D1240007 Lg 6650
kg/m. 2.115
sup. in vista mm. 242

D4230005 Lg 6650

D1240008 Lg 6650
kg/m. 3.292
sup. in vista mm. 259
TAPPO D4220025

D1240011 Lg 6650
kg/m. 2.348
sup. in vista mm. 194

D3240057 Lg 6500
kg/m. 0.278

D3240047 Lg 6650
kg/m. 0.82
sup. in vista mm. 81

D3240049 Lg 6650
kg/m. 0.95
sup. in vista mm. 25

D3240053 Lg 6650
kg/m. 1.26
sup. in vista mm. 177

D4230007 Lg 3300

D3240006 Lg 6650
kg/m. 1.137
sup. in vista mm. 112

D4230006 Lg 6500











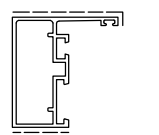
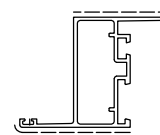
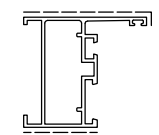
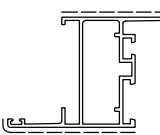
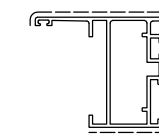
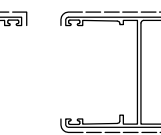
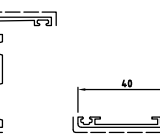
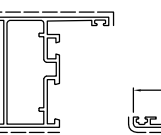
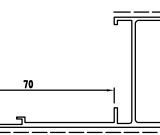
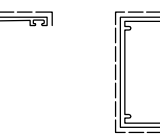
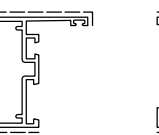
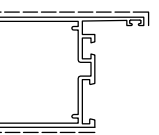
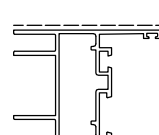
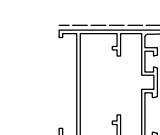
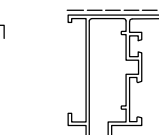
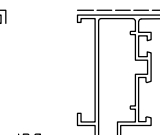
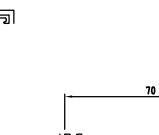
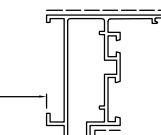
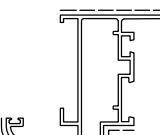
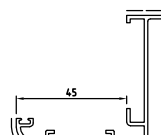
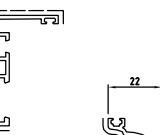
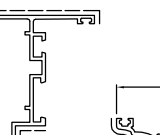
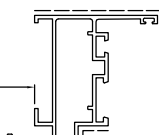
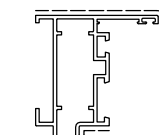
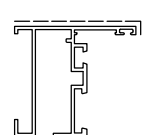
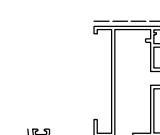
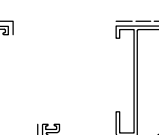

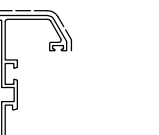
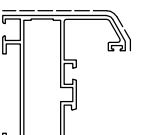
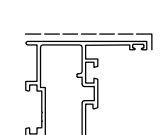
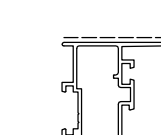
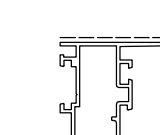
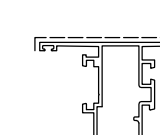
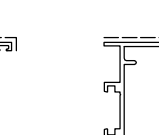
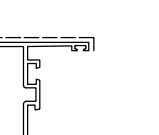
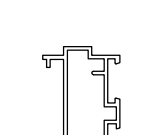
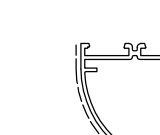
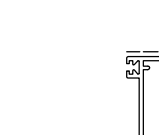
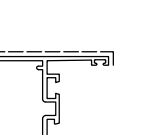



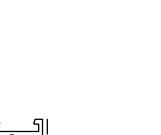

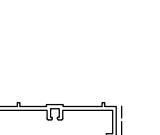



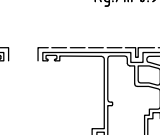
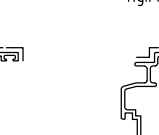
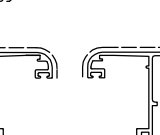
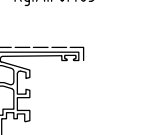
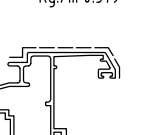
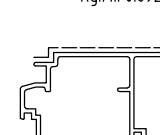
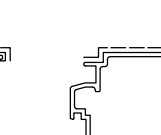

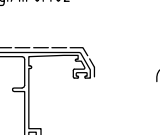
D3240050 Lg 6650
kg/m. 0.30

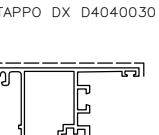
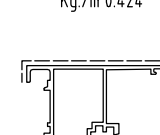
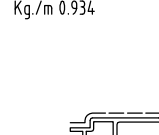
D3240046 Lg 6650
kg/m. 1.63
sup. in vista mm. 224

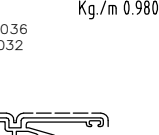
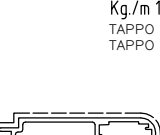
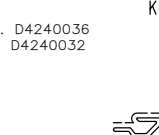
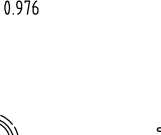
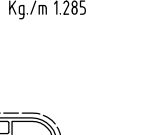
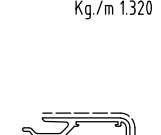
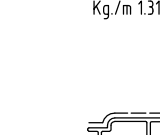
D3074027 Lg 6500
kg/m. 0.1
sup. in vista mm. 20

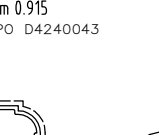

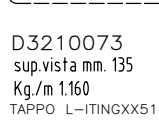
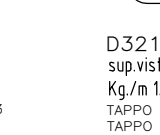
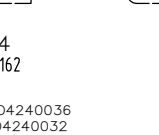
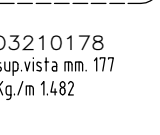

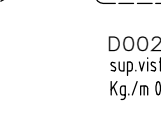
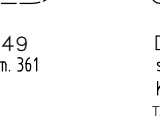
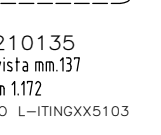
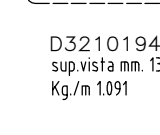
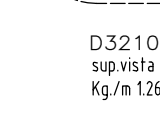
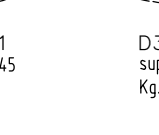





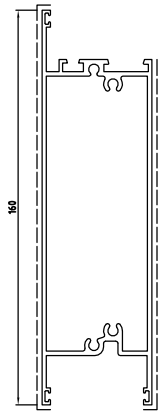
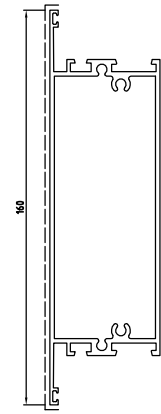
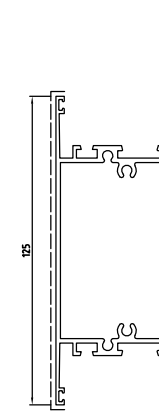
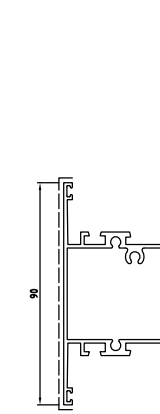
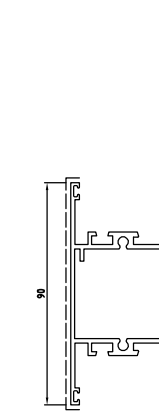
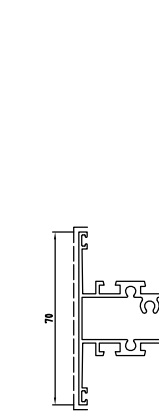
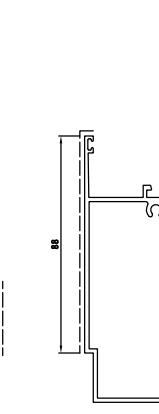
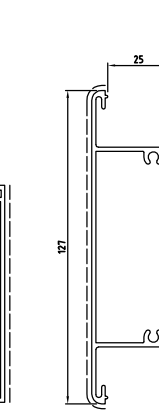
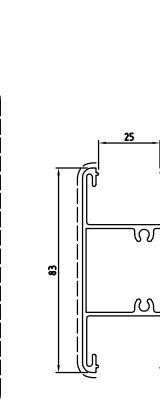
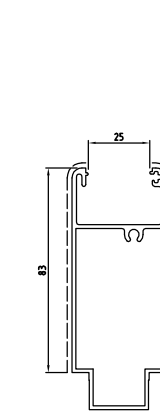
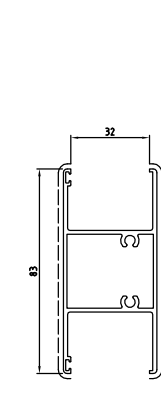
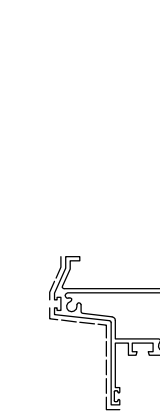

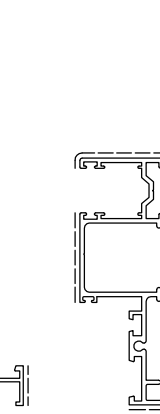

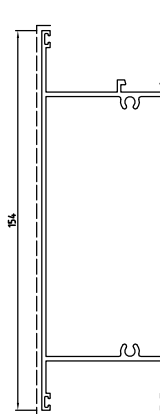
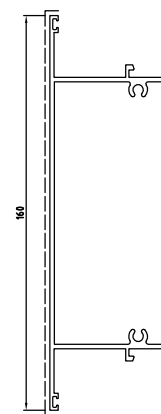
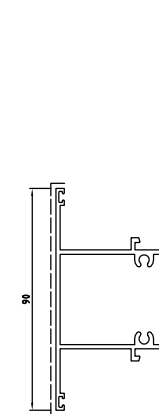
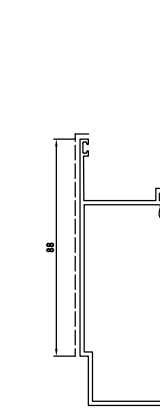

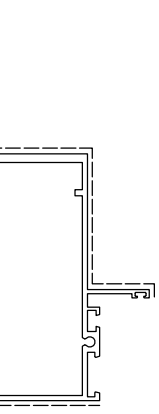
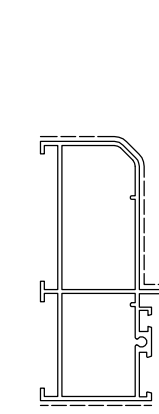
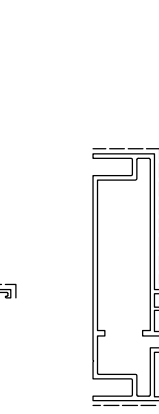
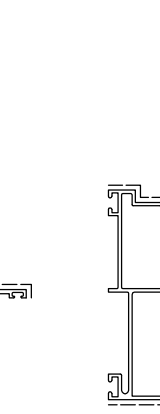
D3074026 Lg 6500
kg/m. 0.306
sup. in vista mm. 90
TAPPO D4074008

Tabellone 1-2

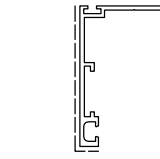
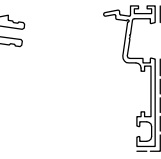
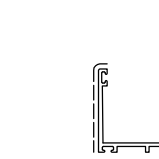
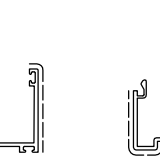
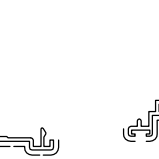
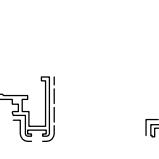
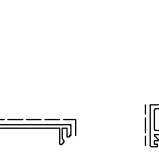
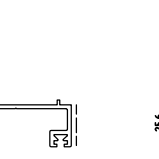
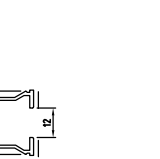
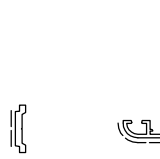
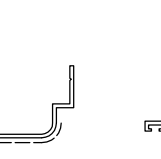
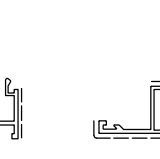
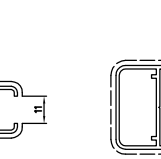
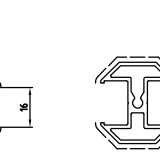
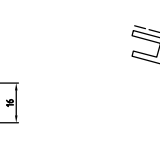
 D3210151 sup.vista mm. 69 Kg./m 0.718	 D3210163 sup.vista mm.95 Kg./m 0.818	 D3210062 sup.vista mm. 83 Kg./m 0.769	 D3210061 sup.vista mm. 109 Kg./m 0.883	 D3210063 sup.vista mm. 109 Kg./m 0.883	 D3210064 sup.vista mm. 134 Kg./m 0.972	 D3210116 sup.vista mm. 127 Kg./m 0.960	 D3210131 sup.vista mm.172 Kg./m 1.180	 D3210152 sup.vista mm. 158 Kg./m 1.047	 D3210182 sup.vista mm. 124 Kg./m 1.123	 D3210120 sup.vista mm. 153 Kg./m 1.225	 D3210121 sup.vista mm. 153 Kg./m 1.225	
 D3210123 sup.vista mm. 103 Kg./m 0.993	 D0026154 sup.vista mm. 103 Kg./m 0.912	 D3210105 sup.vista mm. 80 Kg./m 0.853	 D3210104 sup.vista mm. 109 Kg./m 0.956	 D3210142 sup.vista mm.165 Kg./m 1.204	 D3210167 sup.vista mm. 119 Kg./m 1.018	 D3210177 sup.vista mm.141 Kg./m 1.142	 D3210129 sup.vista mm. 117 Kg./m 0.991	 D3210141 sup.vista mm. 257 Kg./m 1.113	 D3210199 sup.vista mm. 88 Kg./m 0.867	 D3210175 sup.vista mm.118 Kg./m 1.018	 D3210200 sup.vista mm. 133 Kg./m 1.096	
 D3210193 sup.vista mm. 88 Kg./m 0.853	 D3210192 sup.vista mm. 120 Kg./m 1.021	 D3210176 sup.vista mm. 128 Kg./m 1.085	 D3210071 sup.vista mm. 93 Kg./m 0.964	 D3210070 sup.vista mm. 117 Kg./m 1.072	 D3210059 sup.vista mm. 82 Kg./m 0.821	 D3210053 sup.vista mm. 102 Kg./m 0.905	 D3210119 sup.vista mm. 82 Kg./m 0.821	 D3210079 sup.vista mm. 102 Kg./m 0.905	 D3210100 sup.vista mm.124 Kg./m 1.137	 D3210082 sup.vista mm. 147 Kg./m 1.223	 D3210083 sup.vista mm. 147 Kg./m 1.215	
 D3210066 sup.vista mm. 83 Kg./m 0.972	 D3210134 sup.vista mm. 92 Kg./m 0.991	 D3220031 sup.vista mm. 123 Kg./m 1.153	 D3220015 sup.vista mm.68 Kg./m 0.483	 D3210016 sup.vista mm.55 Kg./m 0.379	 D3210126 sup.vista mm.135 Kg./m 0.692	 D3210060 sup.vista mm. 20 Kg./m 0.340	 D3220033 sup.vista mm. 38 Kg./m 0.402	 D3220024 sup.vista mm.53 Kg./m 0.196	 D3091045 kg./m. 0.210 sup. in vista mm. 34 TAPPO SX D4040029 TAPPO DX D4040030	 D3220022 sup.vista mm. 30 Kg./m 0.424	 D3220023 sup.vista mm. 30 Kg./m 0.454	
 D3210047 sup.vista mm. 98 Kg./m 0.934	 D3210048 sup.vista mm. 135 Kg./m 1.133 TAPPO EST. D4240036 TAPPO INT. D4240032	 D3210172 sup.vista mm. 107 Kg./m 0.980	 D3210136 sup.vista mm.205 Kg./m 1.177 TAPPO EST. D4240036 TAPPO INT. D4240032	 D3210111 sup.vista mm. 101 Kg./m 0.976	 D3210049 sup.vista mm. 147 Kg./m 1.285	 D3210173 sup.vista mm. 152 Kg./m 1.320	 D3210156 sup.vista mm. 148 Kg./m 1.318	 D3210137 sup.vista mm.78 Kg./m 0.915 TAPPO D4240043	 D3210081 sup.vista mm. 78 Kg./m 0.875 TAPPO D4240041	 D3210080 sup.vista mm. 82 Kg./m 0.845 TAPPO D4240042	 D3210091 sup.vista mm. 80 Kg./m 0.909	 D3210090 sup.vista mm. 134 Kg./m 1.250
 D3210073 sup.vista mm. 135 Kg./m 1.160 TAPPO L-ITINGXX5103	 D3210074 sup.vista mm. 162 Kg./m 1.350 TAPPO EST. D4240036 TAPPO INT. D4240032	 D3210178 sup.vista mm. 177 Kg./m 1.482	 D3210183 sup.vista mm. 115 Kg./m 1.023	 D0023149 sup.vista mm. 361 Kg./m 0.975	 D3210135 sup.vista mm.137 Kg./m 1.172 TAPPO L-ITINGXX5103	 D3210194 sup.vista mm. 135 Kg./m 1.091	 D3210201 sup.vista mm.145 Kg./m 1.269	 D3210023 sup.vista mm. 135 Kg./m 1.193	 D3210204 sup.vista mm.133 Kg./m 1.169	 D3210198 sup.vista mm. 158 Kg./m 1.291	 D3210159 sup.vista mm. 157 Kg./m 1.296	
 D3210158 sup.vista mm. 110 Kg./m 0.919	 D3210188 sup.vista mm. 115 Kg./m 0.972	 D3210133 sup.vista mm. 115 Kg./m 0.962	 D3210052 sup.vista mm.151 Kg./m 1.266	 D3210162 sup.vista mm. 157 Kg./m 1.293	 D3210161 sup.vista mm. 183 Kg./m 1.423 TAPPO EST. D4240032 TAPPO INT. D4240034	 D3210180 sup.vista mm. 160 Kg./m 1.299	 D3220025 sup.vista mm. 153 Kg./m 1.119 TAPPO D4240033	 D3220026 sup.vista mm. 153 Kg./m 1.119 TAPPO D4240033	 D3220028 sup.vista mm. 56 Kg./m 0.640	 D3220027 sup.vista mm. 14 Kg./m 0.193		

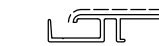
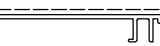
Data: LUGLIO 2013 Doc No. DOC-0000872169

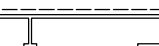
Tabellone 2-2

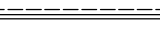
 D3220021 sup.vista mm. 314 Kg./m 2.198	 D3210088 sup.vista mm.287 Kg./m 2.134	 D3210114 sup.vista mm.207 Kg./m 1.795	 D3210117 sup.vista mm.147 Kg./m 1.423	 D3210069 sup.vista mm.147 Kg./m 1.314	 D3210092 sup.vista mm.107 Kg./m 1.058	 D3210094 sup.vista mm. 179 Kg./m 1.396	 D3210075 sup.vista mm. 271 Kg./m 1.755 TAPPO D4240035	 D3210076 sup.vista mm. 181 Kg./m 1.287 TAPPO D4240035	 D3210127 sup.vista mm. 170 Kg./m 1.247	 D3210206 sup.vista mm. 176 Kg./m 1.123	 D3210046 sup.vista mm. 136 Kg./m 1.277	 D3210164 sup.vista mm.55 Kg./m 0.588	 D3210190 sup.vista mm. 151 Kg./m 1.801 TAPPO D4240117	 D3210017 sup.vista mm. 31 Kg./m 0.121
 D3220020 sup.vista mm. 298 Kg./m 2.014	 D3210086 sup.vista mm.287 Kg./m 2.036	 D3210087 sup.vista mm.147 Kg./m 1.287	 D3210085 sup.vista mm. 179 Kg./m 1.361	 D3210093 sup.vista mm. 261 Kg./m 2.268	 D0026115 sup.vista mm.168 Kg./m 1.704	 D3210097 sup.vista mm. 138 Kg./m 1.617	 D0026105 sup.vista mm.122 Kg./m 1.288	 D3210171 sup.vista mm.136 Kg./m 2.060	 D3210057 sup.vista mm. 146 Kg./m 1.392	 D3210058 sup.vista mm. 144 Kg./m 1.080	 D3210018 sup.vista mm. 38 Kg./m 0.143	 D3210197 sup.vista mm. 210 Kg./m 2.346		
 D3290072 sup.vista mm. 64.5 Kg./m 0.898	 D3290071 sup.vista mm. 50 Kg./m 0.551	 D3210056 sup.vista mm. 74 Kg./m 0.559	 D3220029 sup.vista mm. 80 Kg./m 0.375	 D3220030 sup.vista mm. 66 Kg./m 0.478	 D3210067 sup.vista mm. 54 Kg./m 0.249	 D3220032 sup.vista mm. 34 Kg./m 0.480	 D3210174 sup.vista mm. 14.4 Kg./m 0.224	 D3290001 sup.vista mm. 14 Kg./m 0.144	 D0023291 sup.vista mm.98 Kg./m 0.392	 D3220016 sup.vista mm. 20 Kg./m 0.300	 D3210109 sup.vista mm. 80 Kg./m 0.412	 D3290073 sup.vista mm. 97 Kg./m 0.507	 D3290074 sup.vista mm. 76 Kg./m 0.612	
 D0023227 sup.vista mm. - Kg./m 0.419	 D0023173 sup.vista mm. - Kg./m 0.456	 D3290065 sup.vista mm. 135 Kg./m 0.907	 D3290066 sup.vista mm. 224 Kg./m 1.291 TAPPO D6240015	 D0023290 sup.vista mm.100 Kg./m 0.729	 D0023289 sup.vista mm.60 Kg./m 0.481	 D3290080 sup.vista mm. 248 Kg./m 0.937	 D3290063 sup.vista mm. 154 Kg./m 0.942 TAPPO D0080D04	 D3290062 sup.vista mm. 278 Kg./m 1.968 TAPPO D0080D04						

Data: LUGLIO 2013 DocNo. DOC-0000872169

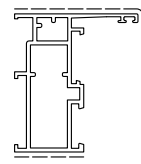

D3210288
sup.vista mm. 81
Kg./m 1.002

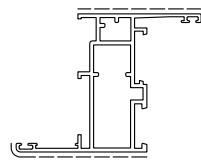

D3210287
sup.vista mm. 109
Kg./m 1.134

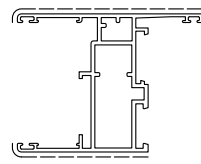

D3210299
sup.vista mm. 136
Kg./m 1.256

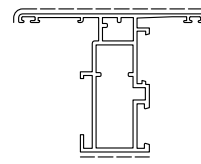

D3210300
sup.vista mm. 109
Kg./m 1.137

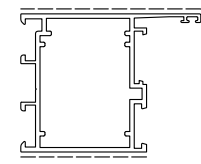

D3210290
sup.vista mm. 127
Kg./m 1.342

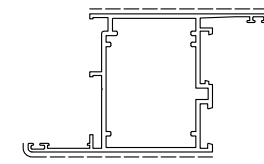

D3210289
sup.vista mm. 152
Kg./m 1.396

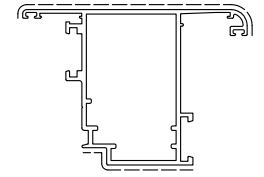

D3210302
sup.vista mm. 152
Kg./m 1.464

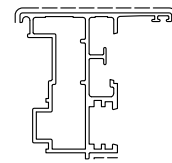

D3210293
sup.vista mm. 81
Kg./m 1.185
TAPPO EST. D4240023
TAPPO INT. D4240025

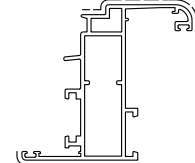

D3210291
sup.vista mm. 105
Kg./m 1.215

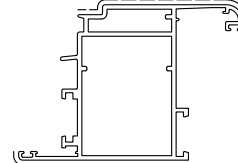

D3210292
sup.vista mm. 149
Kg./m 1.636

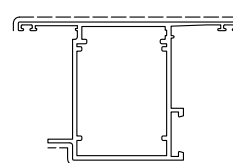

D3220069
sup.vista mm. 156
Kg./m 1.301
TAPPO D0015D30

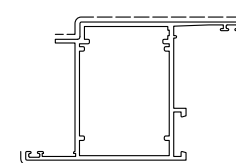

D3220068
sup.vista mm. 152
Kg./m 1.272
TAPPO D0015D30

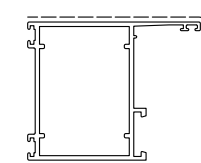

D3220070
sup.vista mm. 121
Kg./m 1.188

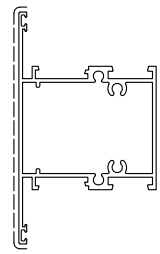

D3210294
sup.vista mm. 96
Kg./m 1.391

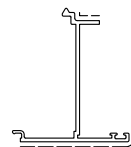

D3220073
sup.vista mm. 60
Kg./m 0.481

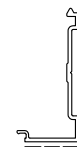

D3220072
sup.vista mm. 22
Kg./m 0.362

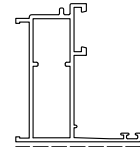

D3210307
sup.vista mm. 60
Kg./m 0.851



D0034373
sup.vista mm. 13.5
Kg./m 0.206

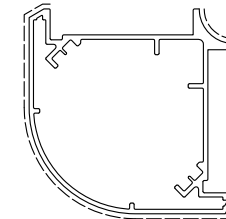

D0024499
sup.vista mm. 174
Kg./m 2.031



D3290001
sup.vista mm. 14
Kg./m 0.144

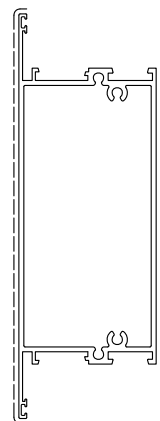

D3210295
sup.vista mm. 236
Kg./m 2.403

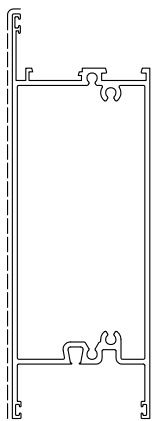

D3220071
sup.vista mm. 311
Kg./m 2.587



D3210311
sup.vista mm. 74
Kg./m 0.604



D3091045
kg./m. 0.210
sup. in vista mm. 34
TAPPO SX D4040029
TAPPO DX D4040030

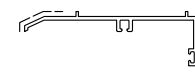

D0024474
sup.vista mm. 35
Kg./m 0.424



D3220015
sup.vista mm.68
Kg./m 0.483

CAVA 32

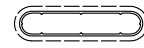

D0050013
sup.vista mm. 111
Kg./m 0.240



D6290118



D3260266
sup.vista mm. 76
Kg./m 0.452
TAPPO D4240172



D3260323
sup.vista mm. 136
Kg./m 0.358



D6702000



D3260324
sup.vista mm. 104
Kg./m 0.523

CAVA 31

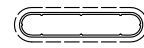

D0050013
sup.vista mm. 111
Kg./m 0.240



D6290201

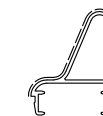

D3260325
sup.vista mm. 86
Kg./m 0.462
TAPPO D4240172

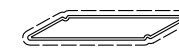

D3260323
sup.vista mm. 136
Kg./m 0.358



D6290202

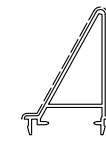

D3260326
sup.vista mm. 103
Kg./m 0.508

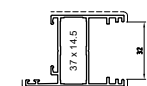

D3260174
sup.vista mm. 108
Kg./m 0.748
TAPPO D0030027

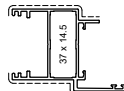

D3260175
sup.vista mm. 137
Kg./m 0.853
TAPPO D0030027
TAPPO D0040007 1/2

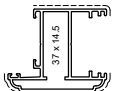

D3260194
sup.vista mm. 116
Kg./m 0.994
TAPPO D0030075

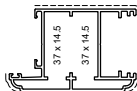

D3260195
sup.vista mm. 148
Kg./m 1.191
TAPPO D0030076

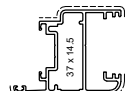

D3260241
sup.vista mm. 146
Kg./m 1.031
TAPPO L-ITL00001

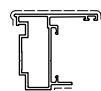

D3210242
sup.vista mm. 74
Kg./m 0.662
TAPPO D0040008
TAPPO D0030017



D3260199
sup.vista mm. 45
Kg./m 0.538
TAPPO D0030072



D3260191
sup.vista mm. 137
Kg./m 0.726
TAPPO D0030091



D3260193
sup.vista mm. 161
Kg./m 0.840
TAPPO D0030092

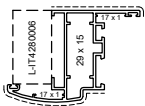

D3210175
sup.vista mm. 118
Kg./m 1.018

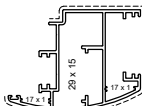

D3260184
sup.vista mm. 150
Kg./m 1.323
TAPPO D013D100

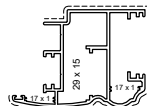

D3260057
sup.vista mm. 161
Kg./m 1.340
TAPPO D4240012

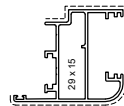

D3260045
sup.vista mm. 130
Kg./m 1.040

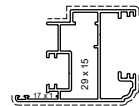

D3260186
sup.vista mm. 142
Kg./m 1.153
TAPPO D0030085

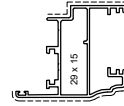

D3260179
sup.vista mm. 129
Kg./m 1.040

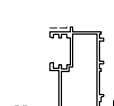

D3210080
sup.vista mm. 82
Kg./m 0.845
TAPPO D4240042
TAPPO D4240015 CHIUDI TUBOLARITA'

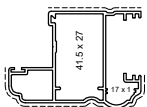

D3260067
sup.vista mm. 156
Kg./m 1.315
TAPPO D4240004

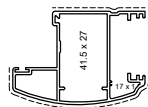

D3260068
sup.vista mm. 147
Kg./m 1.258
TAPPO D4240003

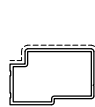

D3260037
sup.vista mm. 84
Kg./m 0.621
TAPPO D4240002

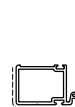

D3260066
sup.vista mm. 43
Kg./m 0.454
TAPPO D4240001

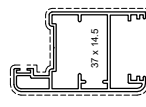

D3260055
sup.vista mm. 210
Kg./m 1.208
TAPPO D0033D01

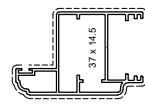

D3260196
sup.vista mm. 210
Kg./m 1.112
TAPPO D0030073

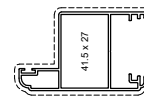

D3260030
sup.vista mm. 189
Kg./m 0.967
TAPPO D0030074

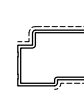

D3260182
sup.vista mm. 101
Kg./m 0.578
TAPPO D0033D02

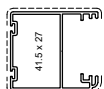

D3260198
sup.vista mm. 145
Kg./m 0.813
TAPPO D0030074

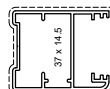

D3260180
sup.vista mm. 190
Kg./m 0.996
TAPPO D0033D01



D3260183
sup.vista mm. 104
Kg./m 0.996



D3250031
sup.vista mm. 37
Kg./m 0.211



D3260204
sup.vista mm. =
Kg./m 0.904

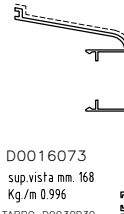

D0016073
sup.vista mm. 168
Kg./m 0.996
TAPPO D0030030

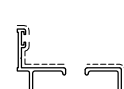

D3260203
sup.vista mm. 152
Kg./m 0.788
TAPPO D00G005



D3260208
sup.vista mm. 61
Kg./m 0.329



D3260211
sup.vista mm. 57
Kg./m 0.207



D3290001
sup.vista mm. 14
Kg./m 0.144



D3210279
sup.vista mm. 23
Kg./m 0.165



D3260218
sup.vista mm. 45
Kg./m 0.354



D3260209
sup.vista mm. 0.537
Kg./m 81



D3260210
sup.vista mm. 47
Kg./m 0.432



D3260216
sup.vista mm. 36
Kg./m 0.201



D3260042
sup.vista mm. 42
Kg./m 0.208



D3260207
sup.vista mm. 7
Kg./m 0.176

D3260040
sup.vista mm. 165
Kg./m 1.207
TAPPO D4240074

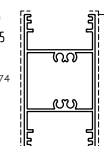

D3260039
sup.vista mm. 182
Kg./m 1.509
TAPPO D4240075

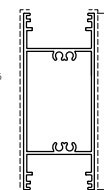

D3260041
sup.vista mm. 272
Kg./m 1.785
TAPPO D4240074

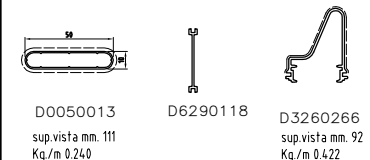
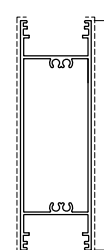

D0050013
sup.vista mm. 111
Kg./m 0.240

D6290118

D3260266
sup.vista mm. 92
Kg./m 0.422
TAPPO D4240172

CAVA 32

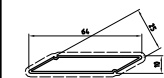

D3260323
sup.vista mm. 136
Kg./m 0.358

D6702000



D3260324
sup.vista mm. 104
Kg./m 0.523

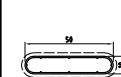

D0050013
sup.vista mm. 111
Kg./m 0.240

D6290201



D3260325
sup.vista mm. 86
Kg./m 0.462
TAPPO D4240172

CAVA 31

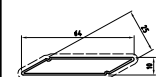

D3260323
sup.vista mm. 136
Kg./m 0.358

D6290202



D3260326
sup.vista mm. 103
Kg./m 0.508

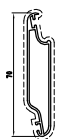

D3260051
sup.vista mm.157
Kg./m 0.490
TAPPO D6290099

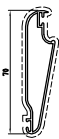

D3260052
sup.vista mm. 160
Kg./m 0.499
TAPPO D6290096

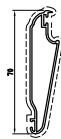

D3260053
sup.vista mm. 158
Kg./m 0.494
TAPPO D6290096

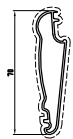

D3260063
sup.vista mm. 175
Kg./m 0.495
TAPPO D6290096

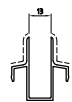

D3260050
sup.vista mm. 47
Kg./m 0.381



D3280007
sup.vista mm. 21
Kg./m 0.311



D3260049
sup.vista mm. 108
Kg./m 0.375

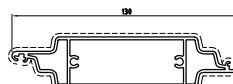

D3260043
sup.vista mm. 293
Kg./m 14.92
TAPPO D4240084



D3B 80005
sup.vista mm. 16
Kg./m 0.273

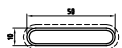

D3280001
sup.vista mm. 0.347
Kg./m 111
TAPPO D4240018 (CAVA 7)
TAPPO D4240086 (CAVA 32)



D3280002
sup.vista mm. 141
Kg./m 0.448
TAPPO D4240019 (CAVA 7)
TAPPO D4240085 (CAVA 32)



D3260129
sup.vista mm. 85
Kg./m 0.405

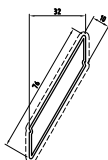

D3260224
sup.vista mm. 160
Kg./m 0.505

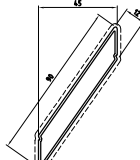

D3260225
sup.vista mm. 190
Kg./m 0.605



D3260212
sup.vista mm. 54
Kg./m 0.378



D0026187
sup.vista mm. 44
Kg./m 0.327



D3280006
sup.vista mm. 25
Kg./m 0.262



D3280005
sup.vista mm. 102
Kg./m 0.358

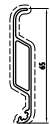

D3280003
sup.vista mm. 166
Kg./m 0.401
TAPPO D4240022



D3260221
sup.vista mm. 104
Kg./m 0.356



D3260223
sup.vista mm. 185
Kg./m 0.516

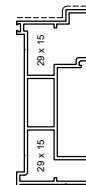

D3B 10052
sup.vista mm. 98
Kg./m 1.783

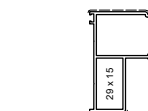

D3B 60016
sup.vista mm. 147
Kg./m 1.248

N.B.:
le cerniere non sono fornite da Domal

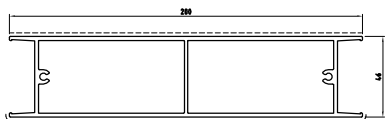

D3220091
sup.vista mm. 405
Kg./m 3.208



D3260206
sup.vista mm. 196
Kg./m 0.991

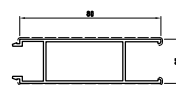

D0017891
sup.vista mm. 166
Kg./m 0.869

FRANGISOLE



D0034640
sup.vista mm. 472
Kg./m 1.933
TAPPO D030D300
REGISTRO D30D301



D0031931
sup.vista mm. 73
Kg./m 0.295



D0031932
sup.vista mm. 431
Kg./m 1.164



D0011006
sup.vista mm. 136
Kg./m 0.310

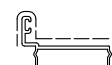

D3260038
sup.vista mm. 61
Kg./m 0.213



D3260011
sup.vista mm. 31
Kg./m 0.145

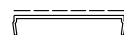

D3260010
sup.vista mm. 45
Kg./m 0.194

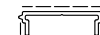

D3260042
sup.vista mm. 42
Kg./m 0.208



D3260024
sup.vista mm. 42
Kg./m 0.270



D3290001
sup.vista mm. 14
Kg./m 0.144

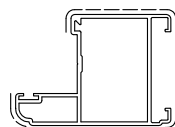

D3260016
sup.vista mm. 128
Kg./m 0.950
TAPPO D4240069

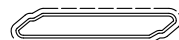

D3260047
sup.vista mm. 139
Kg./m 0.402



D3260048
sup.vista mm. 189
Kg./m 0.583

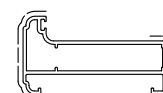

D3260013
sup.vista mm. 72
Kg./m 0.686

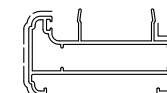

D3260014
sup.vista mm. 77
Kg./m 0.756

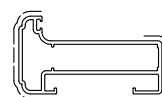

D3260028
sup.vista mm. 91
Kg./m 0.734
TAPPO D4240068
TAPPO D4240083

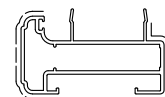

D3260029
sup.vista mm. 97
Kg./m 0.805
TAPPO D4240068
TAPPO D4240083

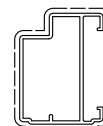

D3260017
sup.vista mm. 112
Kg./m 0.610



D3260035
sup.vista mm. 270
Kg./m 1.366
TAPPO D4240065
TAPPO D4240064

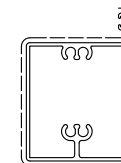

D3260034
sup.vista mm. 190
Kg./m 0.940
TAPPO D4240065
TAPPO D4240064

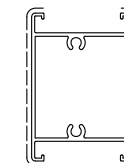

D3260026
sup.vista mm. 140
Kg./m 0.891
TAPPO D4240064

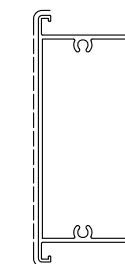

D3260025
sup.vista mm. 220
Kg./m 1.318
TAPPO D4240064

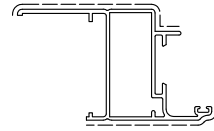

D0050025
sup.vista mm. 134
kg/m 0.905

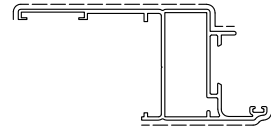

D3260036
sup.vista mm. 155
kg/m 0.992

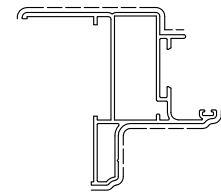

D0050027
sup.vista mm. 151
kg/m 1.121

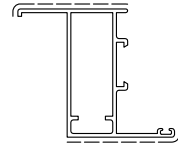

D0050002
sup.vista mm. 95
kg/m 0.845



D0050012
sup.vista mm. 138
kg/m 0.435

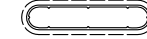

D0050013
sup.vista mm. 111
kg/m 0.240



D3280002
sup.vista mm. 141
kg/m 0.448



D0050016
sup.vista mm. 168
kg/m 0.554

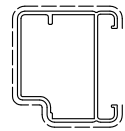

D0050029
sup.vista mm. 128
kg/m 0.656

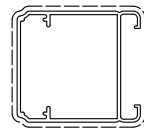

D0050030
sup.vista mm. 152
kg/m 0.764
TAPPO D00AW402

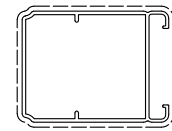

D0050031
sup.vista mm. 169
kg/m 0.805
TAPPO D00AW403

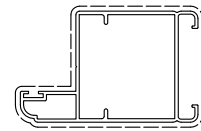

D0050044
sup.vista mm. 193
kg/m 0.948
TAPPO D00AW450

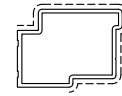

D3260182
sup.vista mm. 101
Kg./m 0.578
TAPPO D0033D02

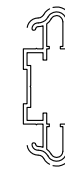

D0050014
sup.vista mm. 60
kg/m 0.545



D0050017
sup.vista mm. 49
kg/m 0.432
TAPPO D00AW303



D0050034
sup.vista mm. 94
kg/m 0.497
TAPPO D00AW303

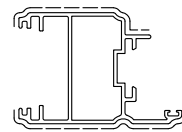

D0050050
sup.vista mm. 139
kg/m 0.999
TAPPO D4240058

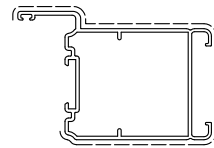

D0050028
sup.vista mm. 158
kg/m 1.015
TAPPO D00AW403
TAPPO D00AW304 (T/Z)

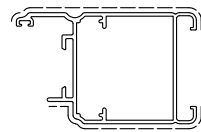

D0050026
sup.vista mm. 138
kg/m 0.986
TAPPO D00AW402
TAPPO D00AW421 (T/Z)

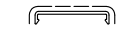

D0050038
sup.vista mm. 40
kg/m 0.211

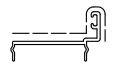

D3260038
sup.vista mm. 61
kg/m 0.213

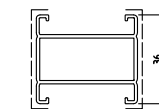

D0050035
sup.vista mm. 98
kg/m 0.594
TAPPO D00AW600

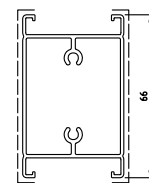

D0050043
sup.vista mm. 151
kg/m 0.988

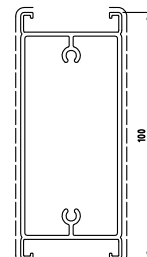

D0050032
sup.vista mm. 219
kg/m 1.420
TAPPO D00AW302 (SPORTELO)
TAPPO D00AW401 (FISSO)

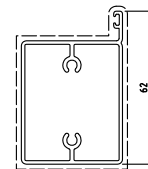

D0050036
sup.vista mm. 210
kg/m 0.888
TAPPO D00AW302 (SPORTELO)
TAPPO D00AW401 (FISSO)

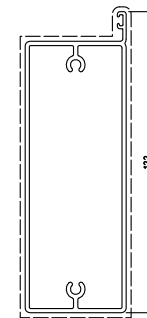

D0050033
sup.vista mm. 325
kg/m 1.588
TAPPO D00AW302 (SPORTELO)
TAPPO D00AW401 (FISSO)



D0050052
sup.vista mm. 40
kg/m 0.346



D3290080
sup.vista mm. 248
Kg./m 0.937

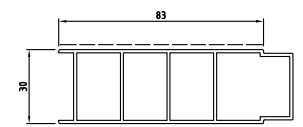

D3290132
sup.vista mm. 186
kg/m 1.126

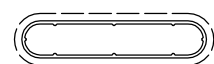

D0050013
sup.vista mm. 111
Kg./m 0.240

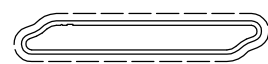

D0050012
sup.vista mm. 138
Kg./m 0.435



D0050016
sup.vista mm. 168
Kg./m 0.554



D0050014
sup.vista mm. 60
Kg./m 0.545



D0050017
sup.vista mm. 49
Kg./m 0.432

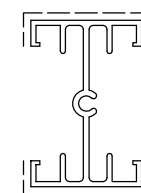

D0050005
sup.vista mm. 98
Kg./m 0.653

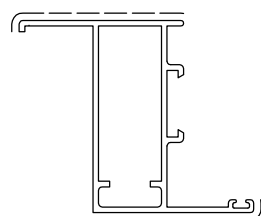

D0050002
sup.vista mm. 95
Kg./m 0.845

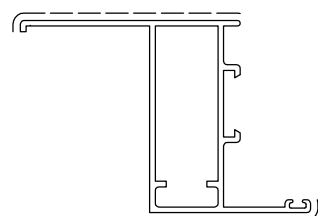

D0050023
sup.vista mm. 110
Kg./m 0.907

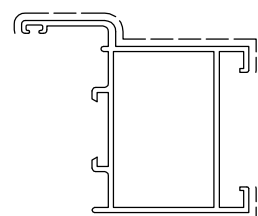

D0050003
sup.vista mm. 128
Kg./m 0.867
TAPPO D00AW042

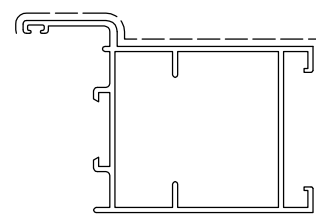

D0050008
sup.vista mm. 162
Kg./m 1.048
TAPPO D00AW043

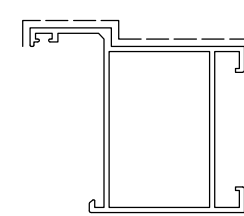

D0050021
sup.vista mm. 124
Kg./m 0.813

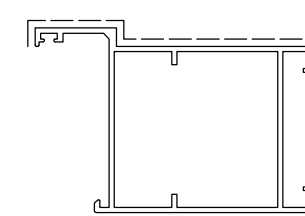

D0050020
sup.vista mm. 158
Kg./m 0.969



D0050060
sup.vista mm. 0
Kg./m 0.219
CLIP L-ITEPFBA67

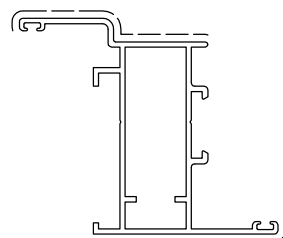

D0026214
sup.vista mm. 112
Kg./m 0.923

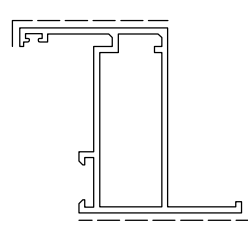

D0052217
sup.vista mm. 85
Kg./m 0.856

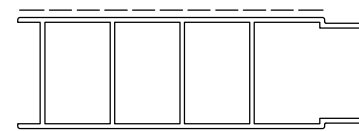

D3290132
sup.vista mm. 186
Kg./m 1.126

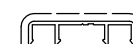

D0050011
sup.vista mm. 41
Kg./m 0.132



D3290001
sup.vista mm. 14
Kg./m 0.144



D0050010
sup.vista mm. 70
Kg./m 0.267

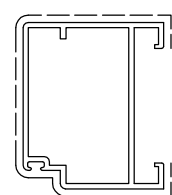

D0050015
sup.vista mm. 132
Kg./m 0.675

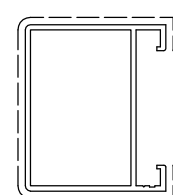

D0050004
sup.vista mm. 135
Kg./m 0.653
TAPPO D00AW042

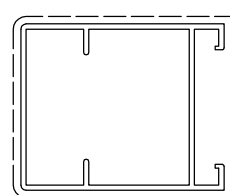

D0050009
sup.vista mm. 169
Kg./m 0.832
TAPPO D00AW043

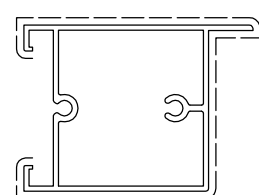

D0050024
sup.vista mm. 187
Kg./m 0.918
TAPPO D0096V89



D0050039
sup.vista mm. 218
Kg./m 1.425

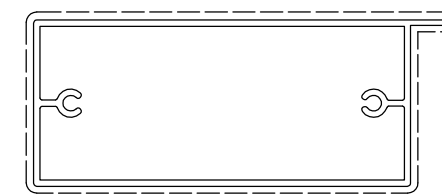

D0050007
sup.vista mm. 318
Kg./m 1.550

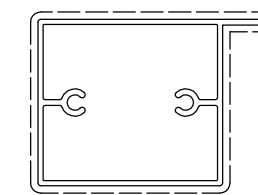

D0050006
sup.vista mm. 212
Kg./m 0.918
TAPPO D0096V88

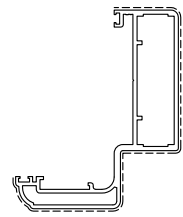

D3260268
sup.vista mm. 178
Kg./m 1.337

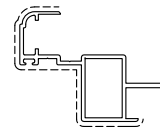

D3280020
sup.vista mm. 111
Kg./m 0.689



D3260237
sup.vista mm. 28
Kg./m 0.143



D3260243
sup.vista mm. 160
Kg./m 0.373
TAPPO 0030D89

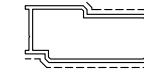

D3260202
sup.vista mm. 99
Kg./m 0.526
TAPPO D0030D90

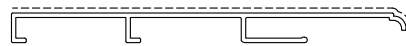

D3280022
sup.vista mm. 164
Kg./m 1.104



D3280021
sup.vista mm. 163
Kg./m 1.558



D3290131
sup.vista mm. 182
Kg./m 0.712

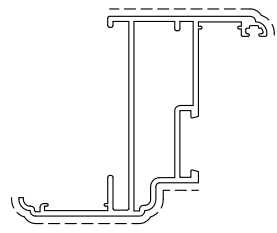

D3260022
Kg./m 0.867
sup.vista mm. 104

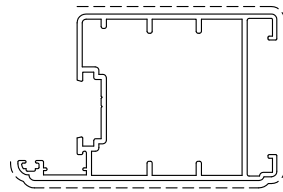

D3260015
Kg./m 0.986
sup.vista mm. 140
TAPPO D4240070

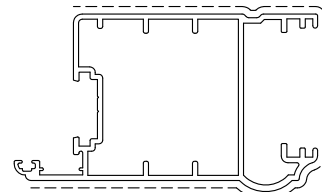

D3260018
Kg./m 1.172
sup.vista mm. 163
TAPPO D4240071

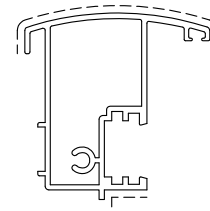

D3260027
Kg./m 0.886
sup.vista mm.77
TAPPO D4240072 DX
TAPPO D4240073 SX

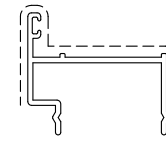

D3260012
Kg./m 0.397
sup.vista mm. 94

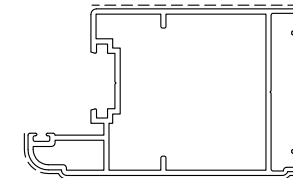

D3260262
kg/m. 1.049
sup. in vista mm.148
TAPPO D4240153

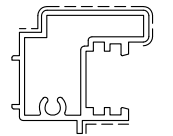

D3260263
kg/m. 0.641
sup. in vista mm.47
TAPPO D4240148 DX
TAPPO D4240149 SX

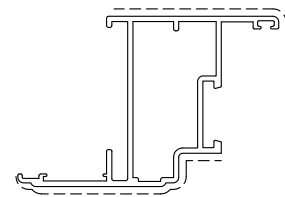

D3260019
Kg./m 0.832
sup.vista mm. 111

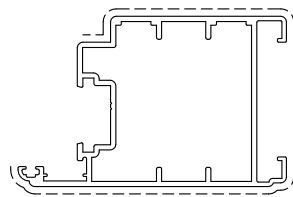

D3260020
Kg./m 1.045
sup.vista mm. 152
TAPPO D4240077

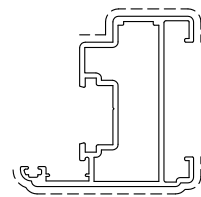

D3260021
Kg./m 0.780
sup.vista mm. 102
TAPPO D4240076

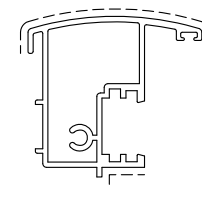

D3260023
Kg./m 0.815
sup.vista mm.72
TAPPO D4240078 DX
TAPPO D4240079 SX

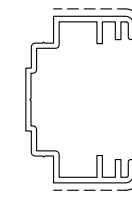

D3260054
Kg./m 0.505
sup.vista mm. 54

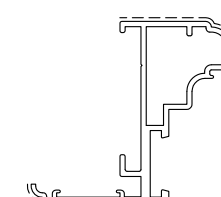

D3260260
kg/m. 0.884
sup. in vista mm.106

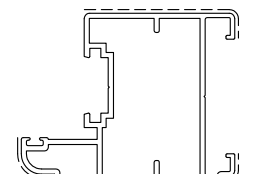

D3260261
kg/m. 0.928
sup. in vista mm. 116
TAPPO D4240153

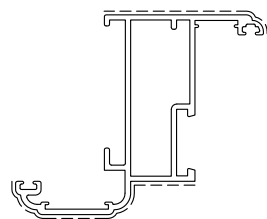

D3260255
kg/m. 0.884
sup. in vista mm. 106

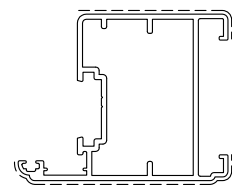

D3260257
kg/m. 0.856
sup. in vista mm. 110
TAPPO D4240152

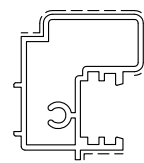

D3260259
kg/m. 0.690
sup. in vista mm. 68
TAPPO D4240146 DX
TAPPO D4240147 SX

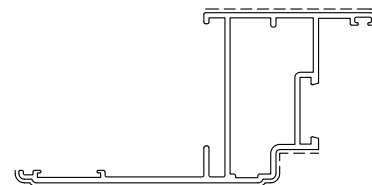

D3260264
kg/m. 0.946
sup. in vista mm. 139

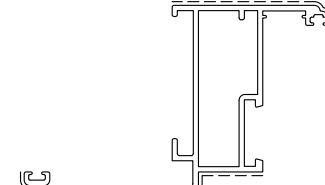

D3260256
kg/m. 0.953
sup. in vista mm. 122



D3260258
kg/m. 0.482
sup. in vista mm. -



D0050060
sup.vista mm. 0
Kg./m 0.219
CLIP L-ITEPFBA67

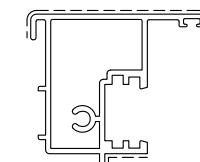

D3260265
kg/m. 0.773
sup. in vista mm. 69
TAPPO D4240150 DX
TAPPO D4240151 SX

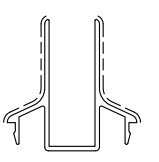

D3260267
kg/m. 0.395
sup. in vista mm. 67

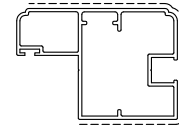

D3260201
sup.vista mm. 183
Kg./m 1.007
TAPPO D030D150

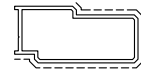

D3260202
sup.vista mm. 99
Kg./m 0.526
TAPPO D0030D90

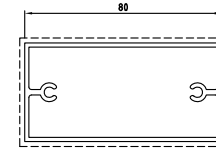

D3260226
sup.vista mm. 240
Kg./m 1.277

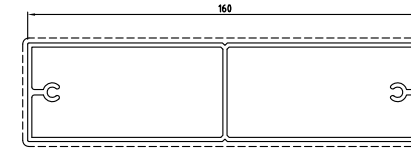

D3260227
sup.vista mm. 400
Kg./m 2.168

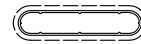

D0050013
sup.vista mm. 111
kg./m 0.240
TAPPO D4240018



D3280001
sup.vista mm. 0.347
Kg./m 111
TAPPO D4240018

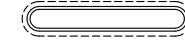

D3280002
sup.vista mm. 141
Kg./m 0.448
TAPPO D4240019

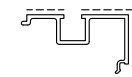

D3260212
sup.vista mm. 54
Kg./m 0.378



D0026187
sup.vista mm. 44
Kg./m 0.327



D3280006
sup.vista mm. 25
Kg./m 0.262

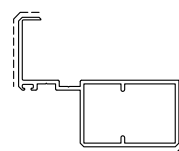

D3260234
sup.vista mm. 80
Kg./m 0.791

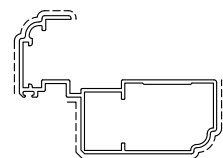

D3260172
sup.vista mm. 159
Kg./m 0.995

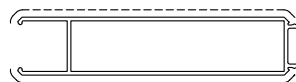

D3290130
sup.vista mm. 187
Kg./m 1.084



D1290003
sup.vista mm. 224
Kg./m 1.604

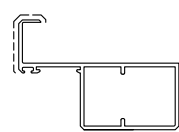

D3260235
sup.vista mm. 94
Kg./m 0.756

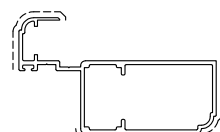

D3260044
sup.vista mm. 120
Kg./m 0.972

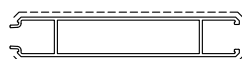

D3290131
sup.vista mm. 182
Kg./m 0.712

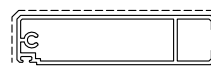

D3260244
sup.vista mm. 192
Kg./m 0.876



D3260245
sup.vista mm. 206
Kg./m 0.910



D3260246
sup.vista mm. 216
Kg./m 0.991

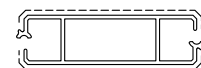

D3260247
sup.vista mm. 142
Kg./m 0.829

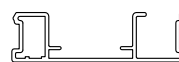

D3260238
sup.vista mm. =
Kg./m 0.724



D3260248
sup.vista mm. 113
Kg./m 0.527

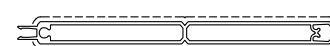

D3290080
sup.vista mm. 248
Kg./m 0.937

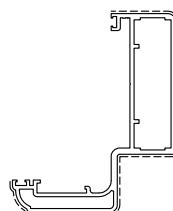

D3260268
sup.vista mm. 178
Kg./m 1.337



D3260243
sup.vista mm. 160
Kg./m 0.373
TAPPO 0030D89

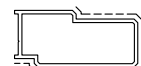

D3260202
sup.vista mm. 99
Kg./m 0.526
TAPPO 0030D90



D3260237
sup.vista mm. 28
Kg./m 0.143

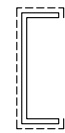

D3260069
sup.vista mm. 79
Kg/m. 0.383

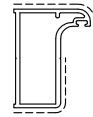

D3260076
sup.vista mm. 73
Kg/m. 0.618



D3260070
sup.vista mm. 90
Kg/m. 0.464

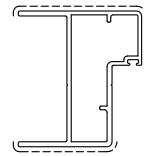

D3260081
sup.vista mm. 106
Kg/m. 1.015

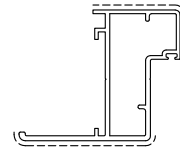

D3260088
sup.vista mm. 109
Kg/m. 1.040



D3260071
sup.vista mm. 121
Kg/m. 0.864
TAPPO D030D102



D3260072
sup.vista mm. 141
Kg/m. 0.940
TAPPO D030D103



D3260073
sup.vista mm. 161
Kg/m. 1.015
TAPPO D030D104

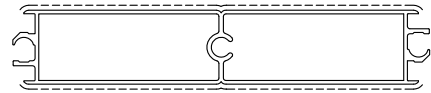

D3260086
sup.vista mm. 322
Kg/m. 1.904



D3260087
sup.vista mm. 485
Kg/m. 2.884



D3260082
sup.vista mm. 176
Kg/m. 0.972

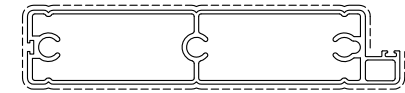

D3260084
sup.vista mm. 356
Kg/m. 2.014



D3260089
sup.vista mm. 79
Kg/m. 0.618
TAPPO D030D101
TAPPO D030D106
TAPPO D030D107



D3260075
sup.vista mm. 73
Kg/m. 0.548
TAPPO D030D101
TAPPO D030D106
TAPPO D030D107



D3260074
sup.vista mm. 55
Kg/m. 0.343
TAPPO D030D100



D3260077
sup.vista mm. 51
Kg/m. 0.567



D3260080
sup.vista mm. 73
Kg/m. 0.556
TAPPO D030D101
TAPPO D030D106
TAPPO D030D107

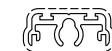

D3260065
sup.vista mm. 64
Kg/m. 0.462



D3260064
sup.vista mm. 595
Kg/m. 3.375

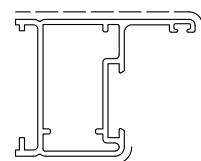

D0050100
kg/m. 0.664
Sup. in vista 82

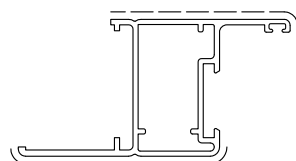

D0050101
kg/m. 0.778
Sup. in vista 109

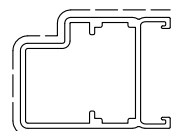

D0050104
kg/m. 0.564
Sup. in vista 115

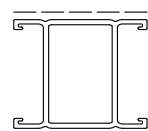

D0050105
kg/m. 0.481
Sup. in vista 74
TAPPO D00AW508

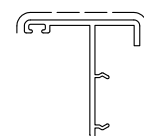

D0050110
kg/m. 0.292
Sup. in vista 49

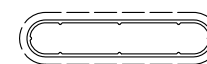

D0050013
kg/m. 0.240
Sup. in vista 111

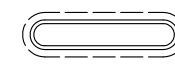

D0050114
kg/m. 0.232
Sup. in vista 89

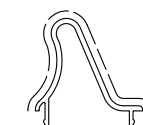

D0050115
kg/m. 0.267
Sup. in vista 65

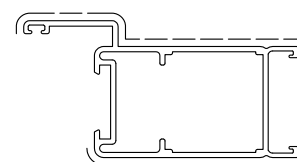

D0050102
kg/m. 0.853
Sup. in vista 179
TAPPO D00AW504

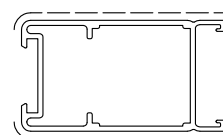

D0050103
kg/m. 0.716
Sup. in vista 118
TAPPO D00AW504



D0050108
kg/m. 0.354
Sup. in vista 17

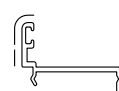

D0050109
kg/m. 0.170
Sup. in vista 14

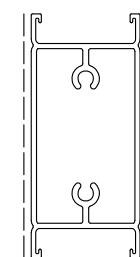

D0050106
kg/m. 0.875
Sup. in vista 134
TAPPO D00AW515 (SPORTELLO)
TAPPO D00AW507 (FISSO)

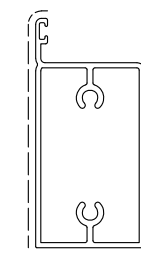

D0050107
kg/m. 0.797
Sup. in vista 114
TAPPO D00AW515 (SPORTELLO)
TAPPO D00AW507 (FISSO)



D3290130
kg/m. 1.084
Sup. in vista 218



D3210017
kg/m. 0.119
Sup. in vista 31



D3210008
kg/m. 0.055
Sup. in vista 16



D0050118
kg/m. 0.454
Sup. in vista /



D3290001
kg/m. 0.144
Sup. in vista 14



D3290080
kg/m. 0.975
Sup. in vista 247



D0050060
sup.vista mm. 0
Kg./m 0.219
CLIP L-ITEPFBA67

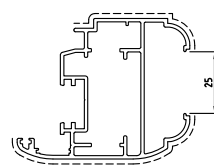

D3210201
sup.vista mm. 145
Kg./m 1.269
TAPPO D4240126

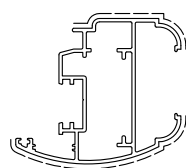

D3210023
sup.vista mm. 135
Kg./m 1.193

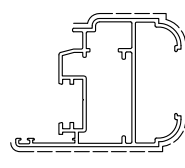

D3210194
sup.vista mm. 135
Kg./m 1.091

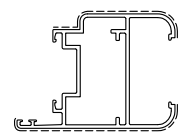

D3210267
sup.vista mm. 134
Kg./m 0.959

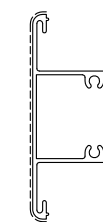

D3210076
sup.vista mm. 181
Kg./m 1.287
TAPPO D0040D09

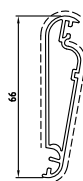

D0007432
sup.vista mm. 134
Kg./m 0.537



D0007507
sup.vista mm. 115
Kg./m 0.383



D3260231
sup.vista mm. 38
Kg./m 0.273

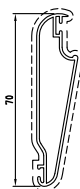

D3260052
sup.vista mm. 160
Kg./m 0.499



D3260049
sup.vista mm. 108
Kg./m 0.375



D3260009
sup.vista mm. 45
Kg./m 0.405

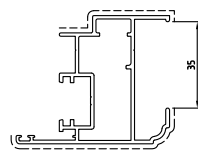

D0027539
sup.vista mm. 132
Kg./m 1.002
TAPPO D0030D85

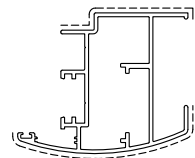

D0060908
sup.vista mm. 139
Kg./m 1.183
TAPPO D4B40001

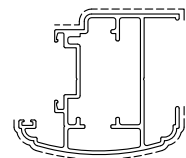

D0060390
sup.vista mm. 145
Kg./m 1.234
TAPPO L-ITLP124

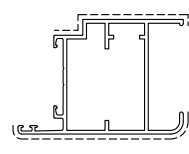

D3260239
sup.vista mm. 355
Kg./m 0.975
TAPPO L-ITES1898

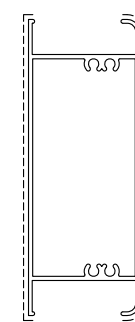

D3260229
sup.vista mm. 255
Kg./m 1.674
TAPPO L-ITES1896

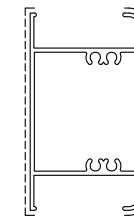

D3260230
sup.vista mm. 175
Kg./m 1.307
TAPPO L-ITES1896

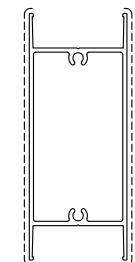

D3220061
sup.vista mm. 207
Kg./m 1.310

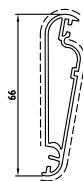

D0007432
sup.vista mm. 134
Kg./m 0.537



D0007507
sup.vista mm. 115
Kg./m 0.383

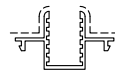

D0007434
sup.vista mm. 45
Kg./m 0.365



D0183513
sup.vista mm. 34
Kg./m 0.195

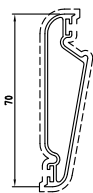

D0007475
sup.vista mm. 129
Kg./m 0.529



D3021002
sup.vista mm. 123
Kg./m 0.450



D3021003
sup.vista mm. 22
Kg./m 0.311

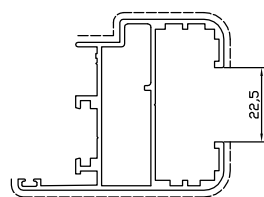

D0027492
sup.vista mm. 140
Kg./m 1.088

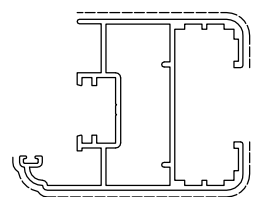

D0060104
sup.vista mm. 148
Kg./m 1.245

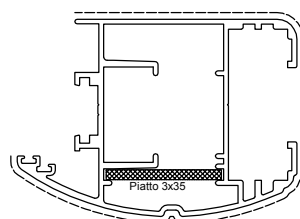

D0060059
sup.vista mm. 188
Kg./m 1.758
TAPPO DX D4B20001
TAPPO SX D4B20002

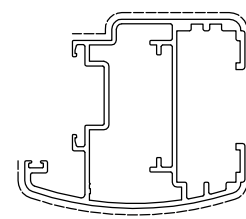

D3B60000
sup.vista mm. 158
Kg./m 1.326

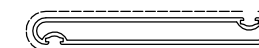

D3032000
sup.vista mm. 148
Kg./m 0.506



D0008209
sup.vista mm. 152
Kg./m 0.527

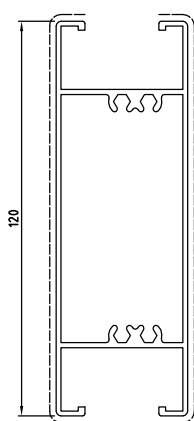



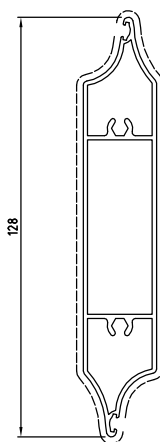



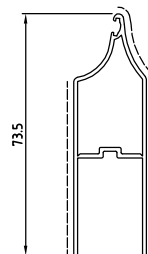



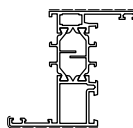
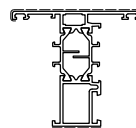
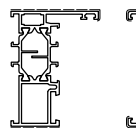
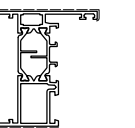
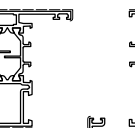
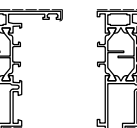
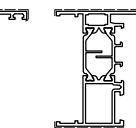
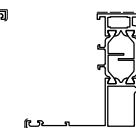
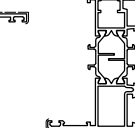
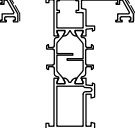
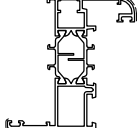
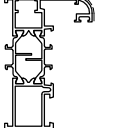
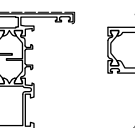
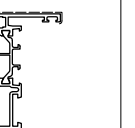
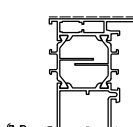
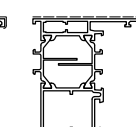
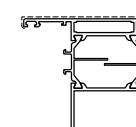
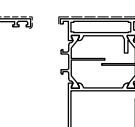
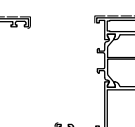
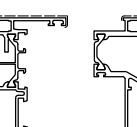
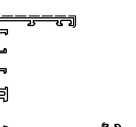
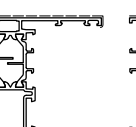
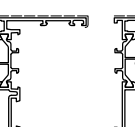
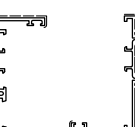
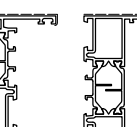

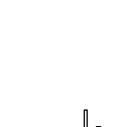
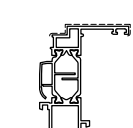
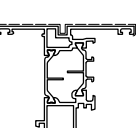
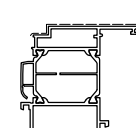
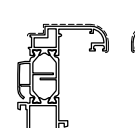
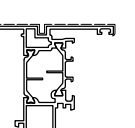
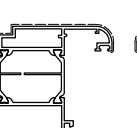
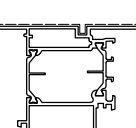
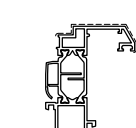
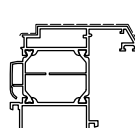
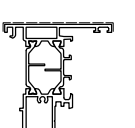
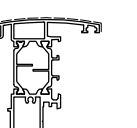
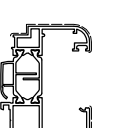
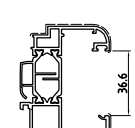
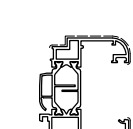
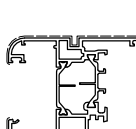
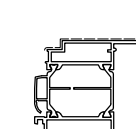
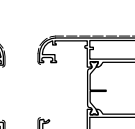
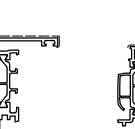
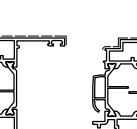
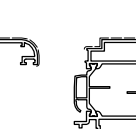
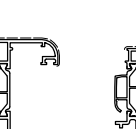
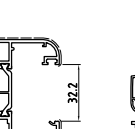
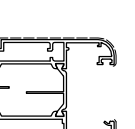
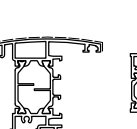
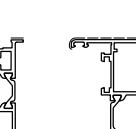
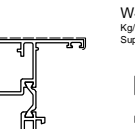
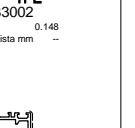
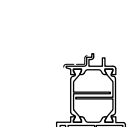
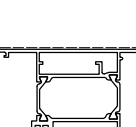

D0027493
sup.vista mm. 275
Kg./m 1.700
TAPPO L-ITES1430

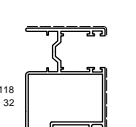

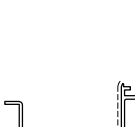
D0027494
sup.vista mm. 259
Kg./m 1.173

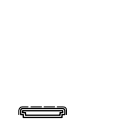

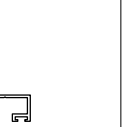
D0007437
sup.vista mm. 152
Kg./m 0.527

 D1210750 Kg/m 1.331 Sup. in vista mm 109	 D1210751 Kg/m 1.331 Sup. in vista mm 110	 D1210752 Kg/m 1.197 Sup. in vista mm 82	 D1210753 Kg/m 1.448 Sup. in vista mm 161	 D1210754 Kg/m 1.370 Sup. in vista mm 116	 1210755 Kg/m 1.489 Sup. in vista mm 122	 D1210757 Kg/m 1.290 Sup. in vista mm 89	 D1210760 Kg/m 1.281 Sup. in vista mm 131	 D1210761 Kg/m 1.417 Sup. in vista mm 126	 D1210780 Kg/m 1.484 Sup. in vista mm 113	 D1210781 Kg/m 1.350 Sup. in vista mm 86	 D1210782 Kg/m 1.484 Sup. in vista mm 113	 D1210783 Kg/m 1.350 Sup. in vista mm 87	 D1210762 Kg/m 1.263 Sup. in vista mm 82	 D1210776 Kg/m 1.473 Sup. in vista mm 76	
 D1210784 Kg/m 1.603 Sup. in vista mm 134	 D1210785 Kg/m 1.470 Sup. in vista mm 107	 D1210763 Kg/m 1.735 Sup. in vista mm 154	 D1210764 Kg/m 1.641 Sup. in vista mm 131	 D1210765 Kg/m 1.774 Sup. in vista mm 154	 D1210777 Kg/m 1.561 Sup. in vista mm 93	 D1210788 Kg/m 1.419 Sup. in vista mm 124	 D1210789 Kg/m 1.285 Sup. in vista mm 97	 D1210786 Kg/m 1.303 Sup. in vista mm 89	 D1210787 Kg/m 1.549 Sup. in vista mm 129	 D1210876 Kg/m 1.473 Sup. in vista mm 109	 D3210016 Kg/m 0.379 Sup. in vista mm 55	 D1210874 Kg/m 0.797 Sup. in vista mm 13			
 D1210801 Kg/m 1.366 Sup. in vista mm 158	 D1210802 Kg/m 1.654 Sup. in vista mm 163 TAPPO EST. D4240303 TAPPO INT. D4240304	 D1210803 Kg/m 1.805 Sup. in vista mm 177	 D1210804 Kg/m 1.432 Sup. in vista mm 164	 D1210805 Kg/m 1.718 Sup. in vista mm 169 TAPPO EST. D4240303 TAPPO INT. D4240304	 D1210806 Kg/m 1.868 Sup. in vista mm 183	 D1210807 Kg/m 2.135 Sup. in vista mm 212 TAPPO EST. D4240303 TAPPO INT. D4240304	 D1210808 Kg/m 1.430 Sup. in vista mm 164	 D1210809 Kg/m 1.867 Sup. in vista mm 183	 D1210810 Kg/m 1.454 Sup. in vista mm 108 TAPPO D4240300	 D1210811 Kg/m 1.492 Sup. in vista mm 109 TAPPO D4240301	 D1210818 Kg/m 1.693 Sup. in vista mm 158	 D1210819 Kg/m 1.604 Sup. in vista mm 151			
 D1210812 Kg/m 1.627 Sup. in vista mm 211	 D1210813 Kg/m 1.915 Sup. in vista mm 216 TAPPO EST. D4240303 TAPPO INT. D4240304	 D1210814 Kg/m 2.065 Sup. in vista mm 230	 D1210815 Kg/m 2.332 Sup. in vista mm 258 TAPPO EST. D4240303 TAPPO INT. D4240304	 D1210828 Kg/m 1.582 Sup. in vista mm 173	 D1210829 Kg/m 1.646 Sup. in vista mm 179	 D1210830 Kg/m 2.080 Sup. in vista mm 198	 D1210816 Kg/m 1.866 Sup. in vista mm 171	 D1210817 Kg/m 2.300 Sup. in vista mm 213	 D1210831 Kg/m 1.458 Sup. in vista mm 108 TAPPO D4240302	 D1210796 Kg/m 1.256 Sup. in vista mm 62	 D1210835 Kg/m 1.973 Sup. in vista mm 157	 D1210820 Kg/m 1.152 Sup. in vista mm 87	 W4033002 Kg/m 0.148 Sup. in vista mm --		
 D1210836 Kg/m 1.387 Sup. in vista mm 92	 D1210837 Kg/m 2.088 Sup. in vista mm 178	 D1210771 Kg/m 2.947 Sup. in vista mm 215	 D1210775 Kg/m 2.046 Sup. in vista mm 85	 D3210017 Kg/m 0.118 Sup. in vista mm 32	 D1210773 Kg/m 2.311 Sup. in vista mm 175 TAPPO D4240117	 D1210875 Kg/m 1.695 Sup. in vista mm 127	 D3210352 Kg/m 0.370 Sup. in vista mm --	 D1210075 Kg/m 2.119 Sup. in vista mm 215	 D3290136 Kg/m 0.184 Sup. in vista mm 33	 D3290137 Kg/m 0.178 Sup. in vista mm 31	 D3091045 Kg/m 0.206 Sup. in vista mm 24 TAPPO SX D4040029 TAPPO DX D4040030	 D3220132 Kg/m 0.198 Sup. in vista mm --	 D1210477 Kg/m 1.491 Sup. in vista mm 67	 D3210020 Kg/m 0.503 Sup. in vista mm 41	 D3220113 Kg/m 0.699 Sup. in vista mm 79
 D3210018 Kg/m 0.142 Sup. in vista mm 38	 D3290066 Kg/m 1.290 Sup. in vista mm 222														

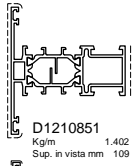

D1210851
Kg/m 1.402
Sup. in vista mm 109

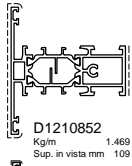

D1210852
Kg/m 1.469
Sup. in vista mm 109

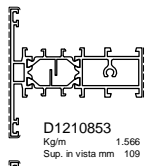

D1210853
Kg/m 1.566
Sup. in vista mm 109

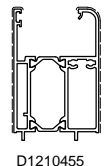

D1210455
Kg/m 1.634
Sup. in vista mm 153

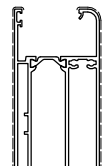

D1210456
Kg/m 2.644
Sup. in vista mm 287

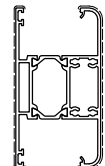

D1210458
Kg/m 1.859
Sup. in vista mm 207

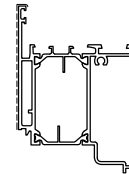

D1210859
Kg/m 1.935
Sup. in vista mm 168

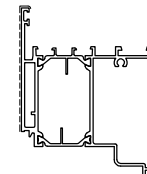

D1210857
Kg/m 2.018
Sup. in vista mm 168

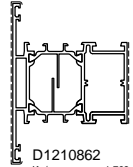

D1210862
Kg/m 1.732
Sup. in vista mm 145

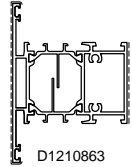

D1210863
Kg/m 1.995
Sup. in vista mm 145

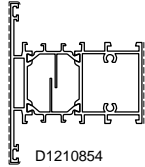

D1210854
Kg/m 1.967
Sup. in vista mm 145

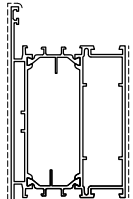

D1210864
Kg/m 2.551
Sup. in vista mm 225

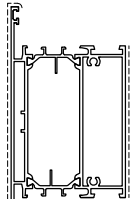

D1210865
Kg/m 2.613
Sup. in vista mm 225

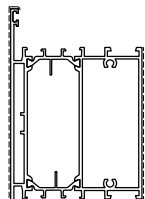

D1210860
Kg/m 2.702
Sup. in vista mm 225

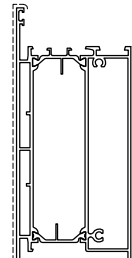

D1210868
Kg/m 3.295
Sup. in vista mm 335

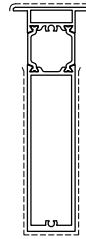

D1211027
Kg/m 2.060
Sup. in vista mm 261

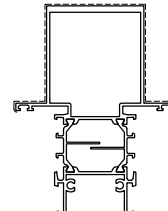

D1210870
Kg/m 2.736
Sup. in vista mm 255

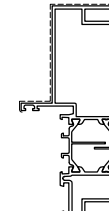

D1210871
Kg/m 2.030
Sup. in vista mm 141

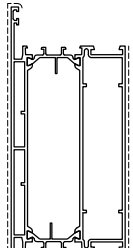

D1210866
Kg/m 3.142
Sup. in vista mm 285

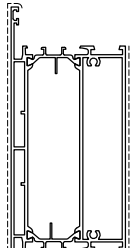

D1210867
Kg/m 3.204
Sup. in vista mm 285

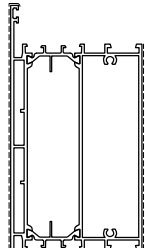

D1210861
Kg/m 3.293
Sup. in vista mm 285

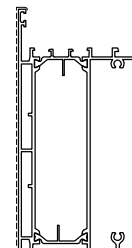

D1210869
Kg/m 3.385
Sup. in vista mm 335

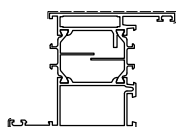

D1210765
Kg/m 1.774
Sup. in vista mm 154

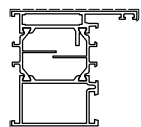

D1210764
Kg/m 1.641
Sup. in vista mm 131



D3290449
Kg/m 0.269
Sup. in vista mm 17

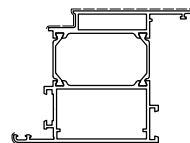

D1210880
Kg/m 2.224
Sup. in vista mm 186

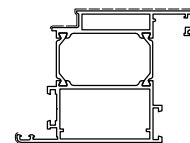

D1210882
Kg/m 2.311
Sup. in vista mm 192

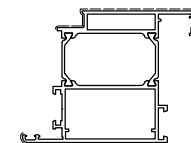

D1210884
Kg/m 2.304
Sup. in vista mm 191

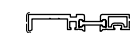

D1210472
Kg/m 0.692
Sup. in vista mm 20

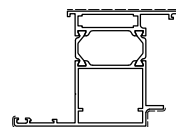

D1210900
Kg/m 1.835
Sup. in vista mm 169

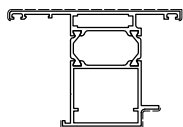

D1210905
Kg/m 1.835
Sup. in vista mm 169



D1001001
Kg/m 0.988
Sup. in vista mm 44

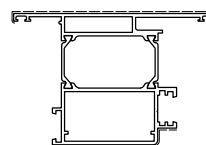

D1210881
Kg/m 2.455
Sup. in vista mm 202
TAPPO EST. D4240166
TAPPO INT. D4240304

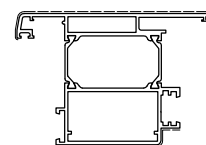

D1210883
Kg/m 2.542
Sup. in vista mm 210
TAPPO EST. D4240166
TAPPO INT. D4240304

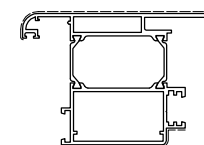

D1210885
Kg/m 2.534
Sup. in vista mm 208
TAPPO EST. D4240166
TAPPO INT. D4240304

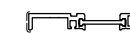

D1210872
Kg/m 0.721
Sup. in vista mm 20

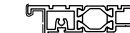

D1210797
Kg/m 1.106
Sup. in vista mm 64
TAPPO PER T/Z D4240173
TAPPO PER STULP D4240174



D1210798
Kg/m 0.982
Sup. in vista mm 92

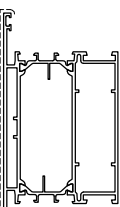

D1210864
Kg/m 2.551
Sup. in vista mm 225

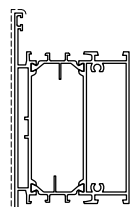

D1210865
Kg/m 2.613
Sup. in vista mm 225

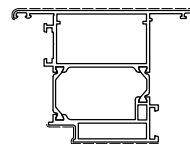

D1210886
Kg/m 2.305
Sup. in vista mm 181

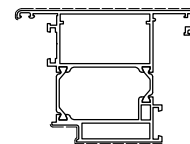

D1210888
Kg/m 2.390
Sup. in vista mm 193

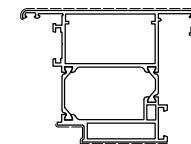

D1210890
Kg/m 2.383
Sup. in vista mm 191



D3290216
Kg/m 0.306
Sup. in vista mm --



D3200035
Kg/m 0.340
Sup. in vista mm --

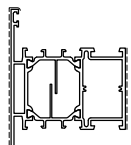

D1210862
Kg/m 1.792
Sup. in vista mm 145

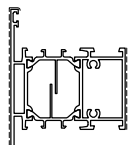

D1210863
Kg/m 1.865
Sup. in vista mm 145

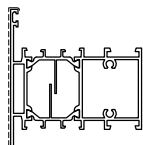

D1210854
Kg/m 1.967
Sup. in vista mm 145

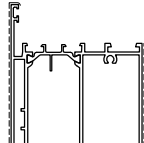

D1210860
Kg/m 2.702
Sup. in vista mm 225

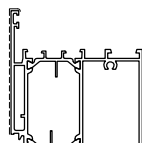

D1210857
Kg/m 2.018
Sup. in vista mm 168

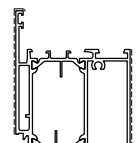

D1210859
Kg/m 1.935
Sup. in vista mm 168

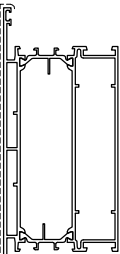

D1210866
Kg/m 3.142
Sup. in vista mm 285

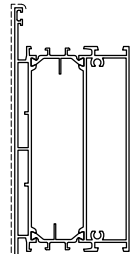

D1210867
Kg/m 3.204
Sup. in vista mm 285

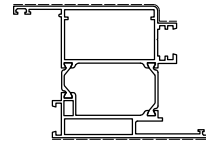

D1210887
Kg/m 2.536
Sup. in vista mm 198
TAPPO EST. D4240304
TAPPO INT. D4240166

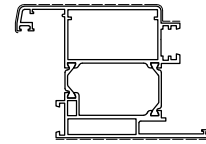

D1210889
Kg/m 2.621
Sup. in vista mm 210
TAPPO EST. D4240304
TAPPO INT. D4240166

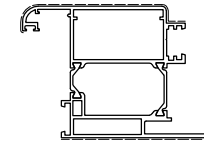

D1210891
Kg/m 2.614
Sup. in vista mm 208
TAPPO EST. D4240304
TAPPO INT. D4240166



D3290217
Kg/m 0.302
Sup. in vista mm 22
TAPPO D4240168



D3290218
Kg/m 0.442
Sup. in vista mm 34
TAPPO D4240168

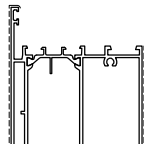

D1210861
Kg/m 3.293
Sup. in vista mm 285

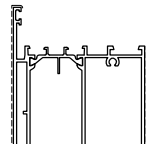

D1210869
Kg/m 3.385
Sup. in vista mm 335

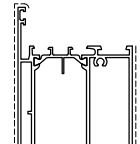

D1210868
Kg/m 3.295
Sup. in vista mm 335

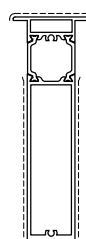

D1211027
Kg/m 2.060
Sup. in vista mm 261

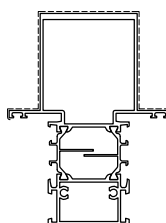

D1210870
Kg/m 2.736
Sup. in vista mm 255

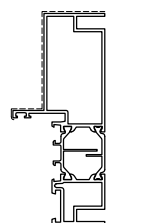

D1210871
Kg/m 2.030
Sup. in vista mm 141

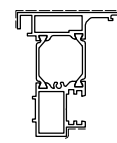

D1210892
Kg/m 1.532
Sup. in vista mm 89
TAPPO D4260167

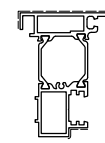

D1210893
Kg/m 1.478
Sup. in vista mm 78
TAPPO D4260167

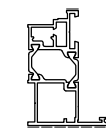

D1210799
Kg/m 1.336
Sup. in vista mm 62



D3091045
Kg/m 0.206
Sup. in vista mm 24
TAPPO SX D4040029
TAPPO DX D4040030



D3220128
Kg/m 0.494
Sup. in vista mm 87



D3220126
Kg/m 0.226
Sup. in vista mm 52

D0062500
kg/m. 1.080
sup. in vista mm. 60

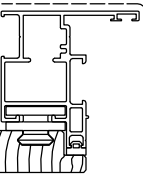

D8260027

D0062500
kg/m. 1.080
sup. in vista mm. 60

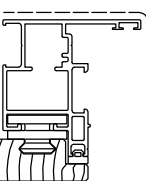

D8260022

D0062500
kg/m. 1.080
sup. in vista mm. 60

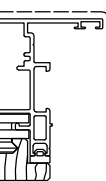

D8260023

D0062501
kg/m. 1.396
sup. in vista mm. 86

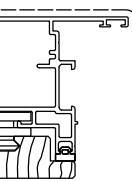

D8260024

D0062501
kg/m. 1.396
sup. in vista mm. 86

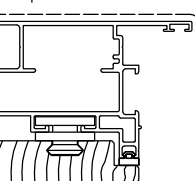

D8260032

D0062502
kg/m. 1.385
sup. in vista mm. 103

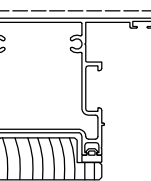

D8260017

D0062506
kg/m. 1.270
sup. in vista mm. 69



TAPPO D4240127

D3210336
kg/m. 0.732
sup. in vista mm. 50



D3210016
kg/m. 0.379
sup. in vista mm. 55



D0062513
kg/m. 1.367
sup. in vista mm. 81

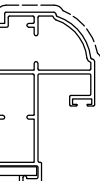

D8260025

D0062514
kg/m. 1.855
sup. in vista mm. 103

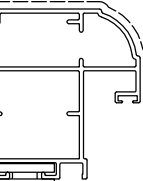

D8260030

D0062507
kg/m. 0.897
sup. in vista mm. 77

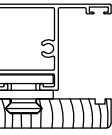

D8260028

D0062503
kg/m. 1.175
sup. in vista mm. 108

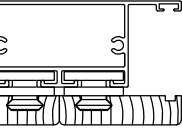

D8260028 D8260028

D3290138
kg/m. 0.140
sup. in vista mm. 18



D0062512
kg/m. 0.200
sup. in vista mm. 27



D3290127
kg/m. 0.222
sup. in vista mm. 29



D3220126
kg/m. 0.225
sup. in vista mm. 51



D3091045
kg/m. 0.210
sup. in vista mm. 34



D0062528
kg/m. 0.457
sup. in vista mm. 42



TAPPO SX D4040029
TAPPO DX D4040030

D0062515
kg/m. 1.450
sup. in vista mm. 76



D8260025

D0062516
kg/m. 1.942
sup. in vista mm. 99

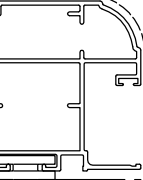

D8260030

D0062508
kg/m. 1.002
sup. in vista mm. 77

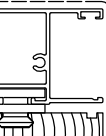

D8260028

D3210030
kg/m. 1.407
sup. in vista mm. 108

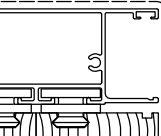

D8260028 D8260028

D0062510
kg/m. 0.214
sup. in vista mm. =



D8260020

D0062511
kg/m. 0.259
sup. in vista mm. =



D8260020

D0062517
kg/m. 1.375
sup. in vista mm. 76



D8260026

D0062518
kg/m. 1.855
sup. in vista mm. 97

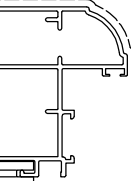

D8260029

D0062509
kg/m. 1.043
sup. in vista mm. 70

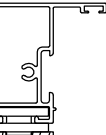

D8260028

D0062525
kg/m. 1.307
sup. in vista mm. 101

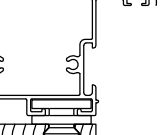

D8260028

D3290178
kg/m. 0.239
sup. in vista mm. =



D8260040

D3290179
kg/m. 0.211
sup. in vista mm. =



D8260040

MATERIALE NON GESTITO A STOCK
ORDINABILE CON MINIMO DI ESTRUSIONE



D0062527
kg/m. 0.810
sup. in vista mm. 81

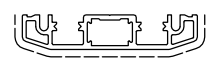

D0062526
kg/m. 0.902
sup. in vista mm. 93

<p>D1210018 kg/m. 1.316 sup. in vista mm. 60</p> <p>D8260027</p>	<p>D1210018 kg/m. 1.316 sup. in vista mm. 60</p> <p>D8260022</p>	<p>D1210018 kg/m. 1.316 sup. in vista mm. 60</p> <p>D8260023</p>	<p>D1210019 kg/m. 1.751 sup. in vista mm. 86</p> <p>D8260024</p>	<p>D1210019 kg/m. 1.751 sup. in vista mm. 86</p> <p>D8260032</p>	<p>D1210020 kg/m. 1.913 sup. in vista mm. 103</p> <p>D8260017</p>	<p>D1210012 kg/m. 2.021 sup. in vista mm. 111</p> <p>D8260024</p>	<p>D1210024 kg/m. 1.537 sup. in vista mm. 69</p> <p>TAPPO D4240127</p>	<p>D0062511 kg/m. 0.259 sup. in vista mm. =</p> <p>D8260020</p>	<p>D3290138 kg/m. 0.140 sup. in vista mm. 18</p>	<p>D0062512 kg/m. 0.200 sup. in vista mm. 27</p>	
<p>D1210028 kg/m. 1.594 sup. in vista mm. 81</p> <p>D8260025</p>	<p>D1210025 kg/m. 1.280 sup. in vista mm. 71</p> <p>D8260028</p>	<p>D1210021 kg/m. 1.654 sup. in vista mm. 108</p> <p>D8260028 D8260028</p>	<p>D1210031 kg/m. 2.103 sup. in vista mm. 93</p> <p>D8260030</p>	<p>D1210042 kg/m. 1.322 sup. in vista mm. 71</p> <p>D8260028</p>	<p>D1210043 kg/m. 1.690 sup. in vista mm. 108</p> <p>D8260028 D8260028 D8260028</p>	<p>D1210105 kg/m. 0.880 sup. in vista mm. 50</p>	<p>D3210016 kg/m. 0.379 sup. in vista mm. 56</p>	<p>D0062510 kg/m. 0.214 sup. in vista mm. =</p> <p>D8260020</p>	<p>D3290127 kg/m. 0.222 sup. in vista mm. 29</p>	<p>D3220126 kg/m. 0.225 sup. in vista mm. 51</p>	
<p>D1210029 kg/m. 1.681 sup. in vista mm. 77</p> <p>D8260025</p>	<p>D1210026 kg/m. 1.413 sup. in vista mm. 71</p> <p>D8260028</p>	<p>D1210022 kg/m. 1.895 sup. in vista mm. 108</p> <p>D8260028 D8260028</p>	<p>D1210032 kg/m. 2.205 sup. in vista mm. 93</p> <p>D8260030</p>	<p>D1210040 kg/m. 1.419 sup. in vista mm. 71</p> <p>D8260028</p>	<p>D1210041 kg/m. 1.972 sup. in vista mm. 108</p> <p>D8260028 D8260028</p>	<p>D1210105 kg/m. 0.880 sup. in vista mm. 50</p>	<p>D3210016 kg/m. 0.379 sup. in vista mm. 56</p>	<p>D3290179 kg/m. 0.211 sup. in vista mm. =</p> <p>D8260040</p>	<p>D3091045 kg/m. 0.210 sup. in vista mm. 34</p> <p>TAPPO SX D4040029 TAPPO DX D4040030</p>	<p>D3210346 kg/m. 0.270 sup. in vista mm. =</p>	
<p>D1210030 kg/m. 1.629 sup. in vista mm. 75</p> <p>D8260026</p>	<p>D1210033 kg/m. 2.177 sup. in vista mm. 97</p> <p>D8260029</p>	<p>D1210027 kg/m. 1.424 sup. in vista mm. 71</p> <p>D8260028</p>	<p>D1210023 kg/m. 1.730 sup. in vista mm. 101</p> <p>D8260028</p>	<p>D1220082 kg/m. 2.651 sup. in vista mm. 150</p> <p>D8260028 D8260028</p>	<p>D0062527 kg/m. 0.810 sup. in vista mm. 81</p>	<p>D0062526 kg/m. 0.902 sup. in vista mm. 93</p>	<p>D3290178 kg/m. 0.239 sup. in vista mm. =</p> <p>D8260040</p>	<p>D0062528 kg/m. 0.457 sup. in vista mm. 42</p>	<p>MATERIALE NON GESTITO A STOCK ORDINABILE CON MINIMO DI ESTRUSIONE</p>		
<p>D1220063 kg/m. 2.225 sup. in vista mm. 108</p> <p>D8260007</p>	<p>D1220081 kg/m. 2.436 sup. in vista mm. 142</p> <p>D8260010</p>	<p>D1220015 kg/m. 2.736 sup. in vista mm. 135</p> <p>D8260010</p>	<p>D1220016 kg/m. 2.539 sup. in vista mm. 127</p> <p>D8260007</p>	<p>D1220017 kg/m. 1.450 sup. in vista mm. 18</p> <p>D8260009</p>	<p>D1210012 kg/m. 2.021 sup. in vista mm. 111</p> <p>D8260024</p>	<p>D1220083 kg/m. 2.836 sup. in vista mm. 150</p> <p>D8260033 D8260028</p>	<p>D1220015 kg/m. 2.736 sup. in vista mm. 135</p> <p>D8260010</p>	<p>D1220016 kg/m. 2.539 sup. in vista mm. 127</p> <p>D8260007</p>	<p>D1220017 kg/m. 1.450 sup. in vista mm. 18</p> <p>D8260009</p>	<p>D1210012 kg/m. 2.021 sup. in vista mm. 111</p> <p>D8260024</p>	<p>D1220083 kg/m. 2.836 sup. in vista mm. 150</p> <p>D8260033 D8260028</p>
<p>TAPPO TIRARE DX D4240013 TAPPO TIRARE SX D4240014</p>		<p>TAPPO SPINGERE DX D4240097 TAPPO SPINGERE SX D4240098</p>									

N.B.* Attenzione lo spazio utile è 45.5mm anzichè 44.5mm dei montanti 1210031 - 1210035.

MATERIALE NON GESTITO A STOCK
ORDINABILE CON MINIMO DI ESTRUSIONE

D1210110
kg/m. 1,342
sup. in vista mm. 64

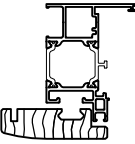

D8260022

D1210110
kg/m. 1,342
sup. in vista mm. 64

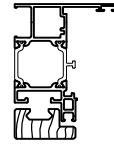

D8260023

D1210110
kg/m. 1,342
sup. in vista mm. 64

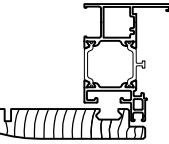

D8260027

D1210117
kg/m. 1,894
sup. in vista mm. 90

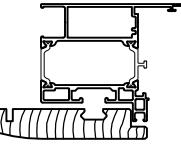

D8260032

D1210117
kg/m. 1,894
sup. in vista mm. 90

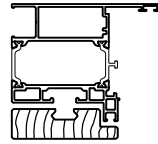

D8260024

D1210113
kg/m. 2,414
sup. in vista mm. 125

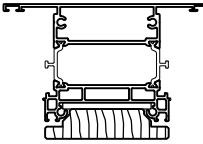

D8260046

D1210160
kg/m. 1,529
sup. in vista mm. 154

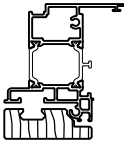

D8260047

D1210111
kg/m. 1,600
sup. in vista mm. 74

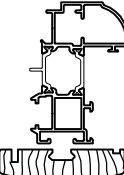

D8260025

D1158000
kg/m. 1,626
sup. in vista mm. 77

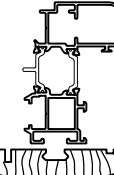

D8260025

D1210118
kg/m. 2,156
sup. in vista mm. 96

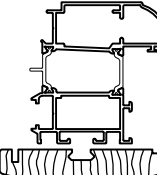

D8260030

D1210115
kg/m. 1,503
sup. in vista mm. 54

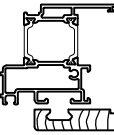

D8260028

D1210161
kg/m. 2,300
sup. in vista mm. 125

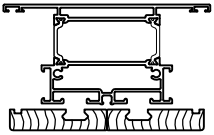

D8260050 D8260050

D1210114
kg/m. 0,944
sup. in vista mm. 48

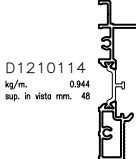

D8260040

D3290202
kg/m. 0,479
sup. in vista mm. 72



D8260038

D1210112
kg/m. 1,578
sup. in vista mm. 74

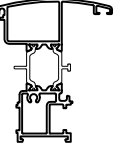

TAPPO D4240021

D1210111
kg/m. 1,600
sup. in vista mm. 74

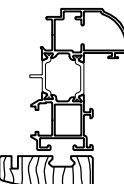

D8260026

D1158000
kg/m. 1,626
sup. in vista mm. 77

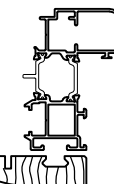

D8260026

D1210118
kg/m. 2,156
sup. in vista mm. 96

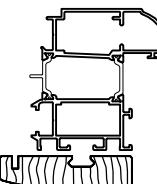

D8260029

D1210116
kg/m. 1,517
sup. in vista mm. 54

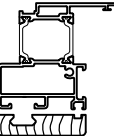

D8260028

D1210162
kg/m. 2,289
sup. in vista mm. 125

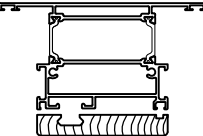

D8260049

D3290209
kg/m. 0,214
sup. in vista mm. =



D8260040

D3290206
kg/m. 0,231
sup. in vista mm. =



D8260038

D3290203
kg/m. 0,250
sup. in vista mm. =



D8260051

D3290201
kg/m. 0,173
sup. in vista mm. =

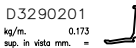

D8260040

D3290179
kg/m. 0,211
sup. in vista mm. =



D8260040

D3290204
kg/m. 0,255
sup. in vista mm. =



D8260038

D3290205
kg/m. 0,282
sup. in vista mm. =



D8260051

D1240042 Lg 6650

kg/m. 2.300
sup. in vista mm. 229

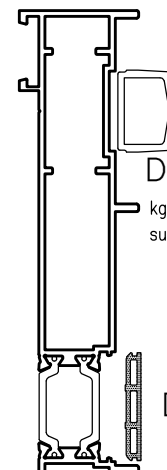

D3240055 Lg 6500

kg/m. 0.273
sup. in vista mm. 42

D4210066

D3240054 Lg 6500

kg/m. 0.200
sup. in vista mm. 27

D1240038 Lg 6650

kg/m. 2.170
sup. in vista mm. 202

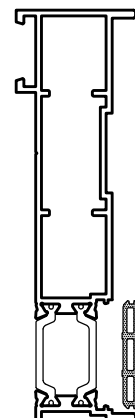

D4210066

D3290094 Lg 6500

kg/m. 0.285
sup. in vista mm. 39

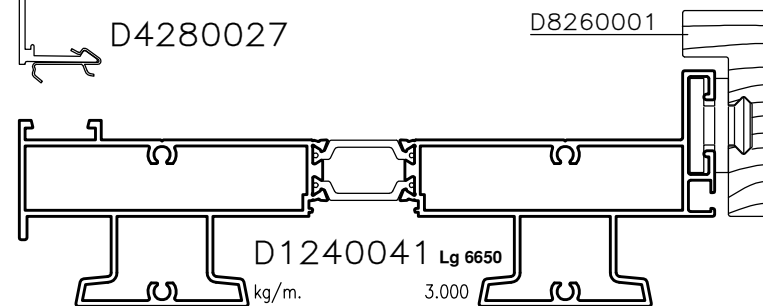

D4280027

D8260001

D1240041 Lg 6650

kg/m. 3.000
sup. in vista mm. 340
TAPPO D4240019

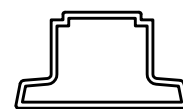

D3240048 Lg 6650

kg/m. 0.52
sup. in vista mm. 102



D3240052 Lg 6650

kg/m. 0.33
sup. in vista mm. 62



D3240051 Lg 6650

kg/m. 0.44
sup. in vista mm. 74

D4230005

Lg 6650

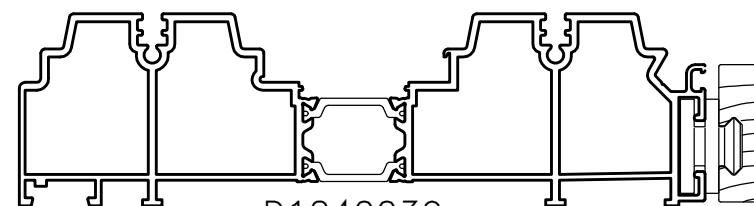

D1240039 Lg 6650

kg/m. 3.340
sup. in vista mm. 210
TAPPO D4240019

D8260002

D3290125 Lg 6500

kg/m. 0.302
sup. in vista mm. 59



D4000000

Acc. Inox

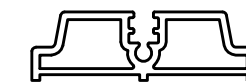

D3240047 Lg 6650

kg/m. 0.82
sup. in vista mm. 81

D3290126 Lg 6500

kg/m. 0.626
sup. in vista mm. 39

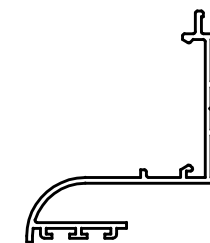

D3240056 Lg 6500

kg/m. 0.384



D3240046 Lg 6650

kg/m. 1.63
sup. in vista mm. 224

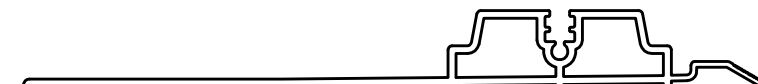

D3240057 Lg 6500

kg/m. 0.278



D0062511

kg/m. 0.259
sup. in vista mm. 42

D8260006

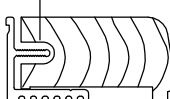

D4230007

Lg 3300

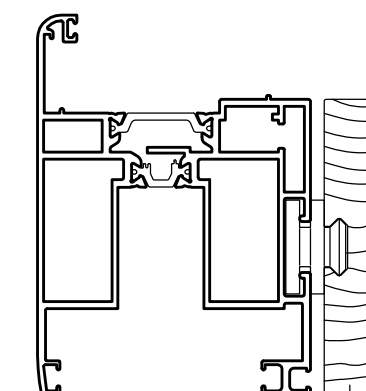
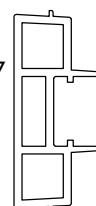

D1240043

kg/m. 2.480
sup. in vista mm. 109
Lg 6650

D8260004

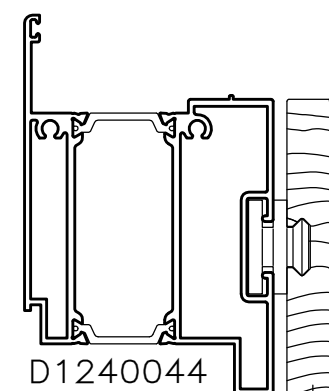

D1240044

kg/m. 2.106
sup. in vista mm. 78
Lg 6650

D8260004

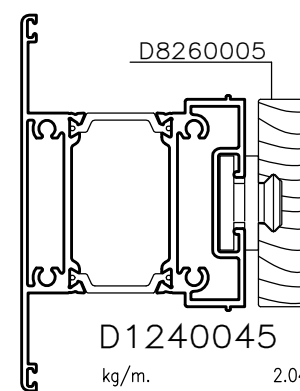

D1240045

kg/m. 2.048
sup. in vista mm. 102
Lg 6650

D8260005

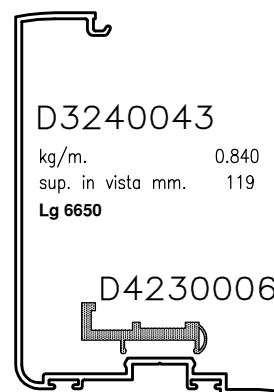

D3240043

kg/m. 0.840
sup. in vista mm. 119
Lg 6650

D4230006

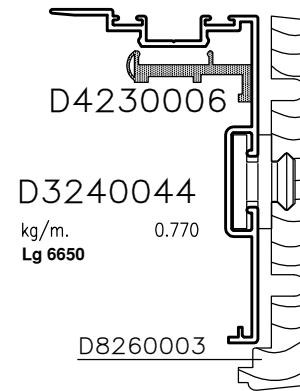

D4230006

D3240044

kg/m. 0.770
Lg 6650

D8260003

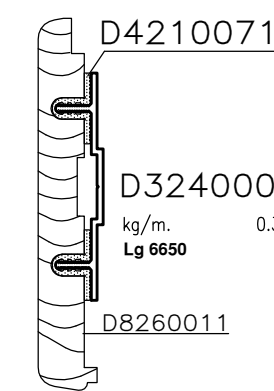

D4210071

D3240005

kg/m. 0.323
Lg 6650

D8260011

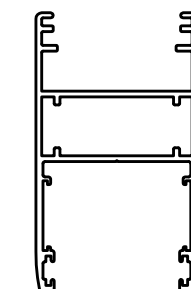

D3240053 Lg 6650

kg/m. 1.26
sup. in vista mm. 177

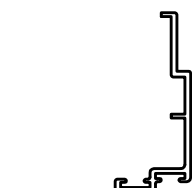

D3240050 Lg 6650

kg/m. 0.30

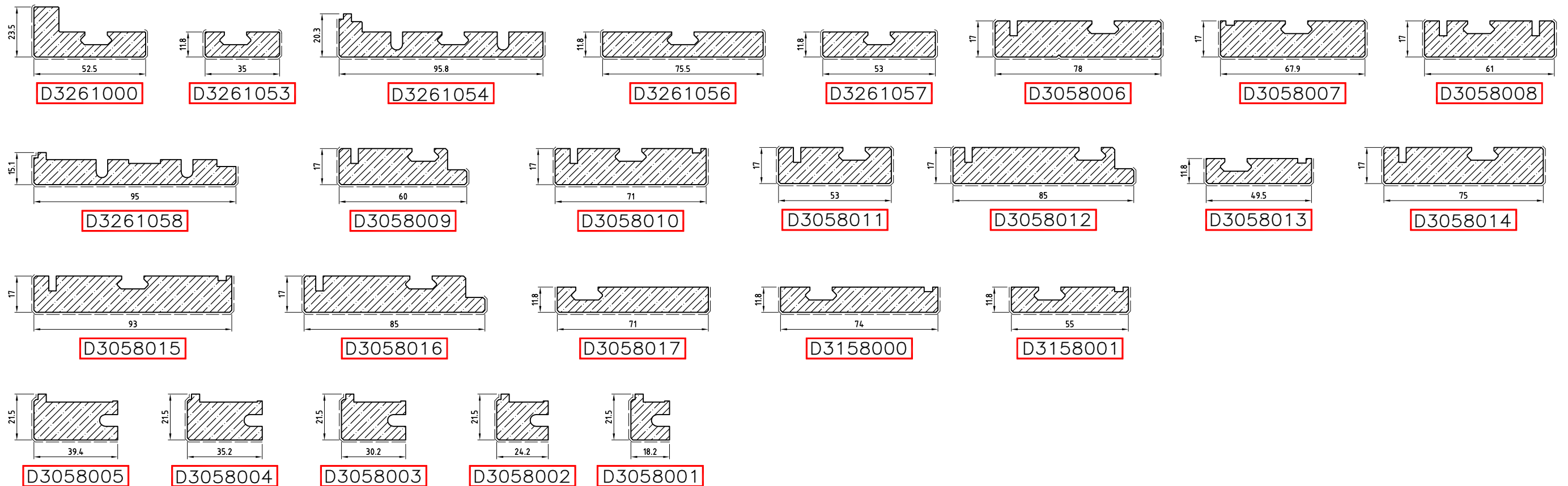
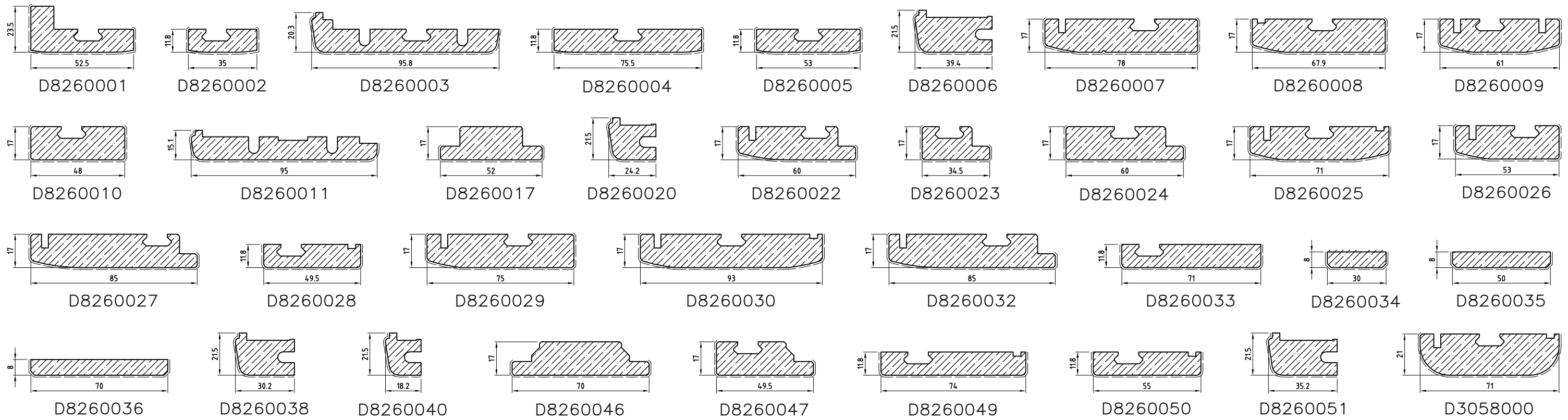

SAGOME NUOVA OFFERTA MASSELLI QUADRATI

D3290129 Kg/m 0.409 sup. in vista mm. 74						54
D3290099 Kg/m 0.383 sup. in vista mm. 67.5					D3290122 Kg/m 0.524 sup. in vista mm. 67.5	47.5
D0024315 Kg/m 0.359 sup. in vista mm. 62					D3290121 Kg/m 0.481 sup. in vista mm. 62	42
D3290023 Kg/m 0.345 sup. in vista mm. 58.5					D3290052 Kg/m 0.456 sup. in vista mm. 58.5	38.5
D3290026 Kg/m 0.332 sup. in vista mm. 55	● D3290033 Kg/m 0.293 sup. in vista mm. 55	D3290034 Kg/m 0.322 sup. in vista mm. 55		D3290047 Kg/m 0.321 sup. in vista mm. 51.5	D3290120 Kg/m 0.428 sup. in vista mm. 55	35
					D3290092 Kg/m 0.417 sup. in vista mm. 53	33
D3290021 Kg/m 0.319 sup. in vista mm. 51.5	● D3290035 Kg/m 0.279 sup. in vista mm. 49	D3290040 Kg/m 0.308 sup. in vista mm. 49	D3290044 Kg/m 0.308 sup. in vista mm. 49	D3290050 Kg/m 0.305 sup. in vista mm. 48	D3290119 Kg/m 0.402 sup. in vista mm. 51.5	31.5
D3290025 Kg/m 0.301 sup. in vista mm. 47.5	● D3290224 Kg/m 0.263 sup. in vista mm. 45	D3290030 Kg/m 0.293 sup. in vista mm. 45		D3290045 Kg/m 0.289 sup. in vista mm. 44	D3290118 Kg/m 0.375 sup. in vista mm. 47.5	27.5
D3290024 Kg/m 0.289 sup. in vista mm. 44.5	● D3290036 Kg/m 0.251 sup. in vista mm. 42	D3290038 Kg/m 0.279 sup. in vista mm. 42	D3290043 Kg/m 0.281 sup. in vista mm. 42		D3290117 Kg/m 0.359 sup. in vista mm. 44.5	24.5
D3290020 Kg/m 0.259 sup. in vista mm. 41	● D3290028 Kg/m 0.238 sup. in vista mm. 38	D3290037 Kg/m 0.250 sup. in vista mm. 38	D3290042 Kg/m 0.251 sup. in vista mm. 38	D3290046 Kg/m 0.248 sup. in vista mm. 38	D3290116 Kg/m 0.342 sup. in vista mm. 41	21
D3290019 Kg/m 0.248 sup. in vista mm. 37.5	● D3290032 Kg/m 0.222 sup. in vista mm. 35	D3290031 Kg/m 0.239 sup. in vista mm. 35		D3290048 Kg/m 0.237 sup. in vista mm. 34	D3290115 Kg/m 0.323 sup. in vista mm. 37.5	17.5
D3290018 Kg/m 0.240 sup. in vista mm. 34	● D3290029 Kg/m 0.208 sup. in vista mm. 31	D3290039 Kg/m 0.230 sup. in vista mm. 34	D3290041 Kg/m 0.230 sup. in vista mm. 31		D3290051 Kg/m 0.313 sup. in vista mm. 34	14
D3290017 Kg/m 0.231 sup. in vista mm. 30.5		D3290049 Kg/m 0.221 sup. in vista mm. 28			D3290114 Kg/m 0.308 sup. in vista mm. 30.5	10.5
D3290027 Kg/m 0.219 sup. in vista mm. 27						7
D3290022 Kg/m 0.181 sup. in vista mm. 23.5						3.5

● CLIPS IN PLASTICA D4240039 (UTILIZZARE SOLO SU UNO DEI LATI CORTI)

NB: PER L'UTILIZZO DEI FERMAVETRI CONSULTARE IL RELATIVO MANUALE DOMAL

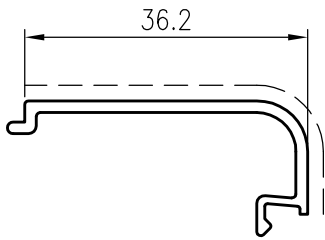

D3290123
sup.vista mm. 48
Kg./m 0.233

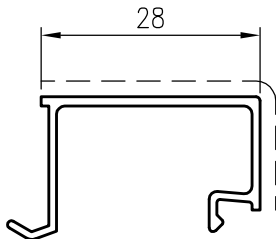

D3290106
sup.vista mm. 42
Kg./m 0.231

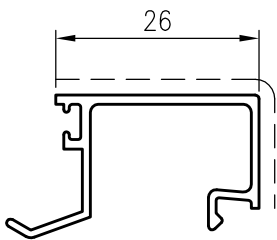

D3290105
sup.vista mm. 40.5
Kg./m 0.231

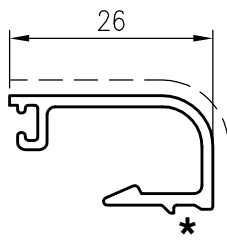

D3290110
sup.vista mm. 38
Kg./m 0.226

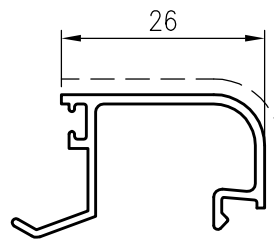

D3290108
sup.vista mm. 38
Kg./m 0.228

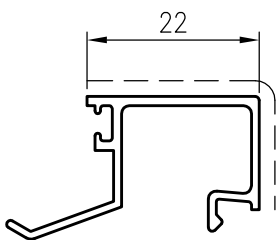

D3290104
sup.vista mm. 36.5
Kg./m 0.225

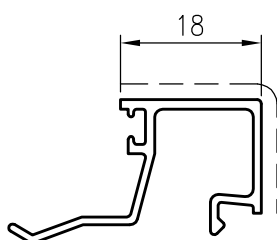

D3290103
sup.vista mm. 32.5
Kg./m 0.221

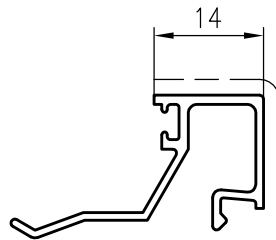

D3290102
sup.vista mm. 28.5
Kg./m 0.215

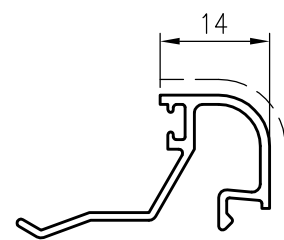

D3290107
sup.vista mm. 26
Kg./m 0.213

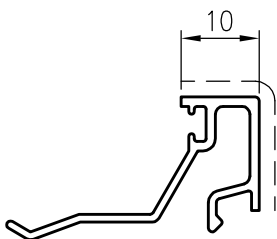

D3290101
sup.vista mm. 24.5
Kg./m 0.210

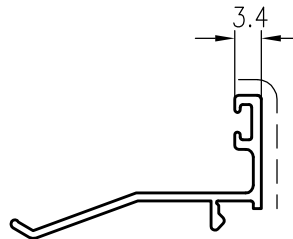

D3290100
sup.vista mm. 18
Kg./m 0.160

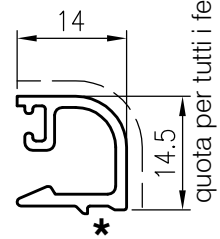

D3290109
sup.vista mm. 25.5
Kg./m 0.181

D3290123

D3290106

D3290105-D3290110-D3290108

D3290104

D3290103

D3290102-D3290107-D3290109

D3290101

D3290100

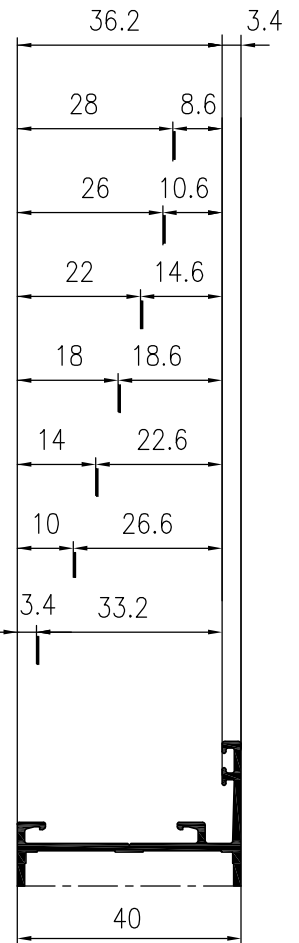

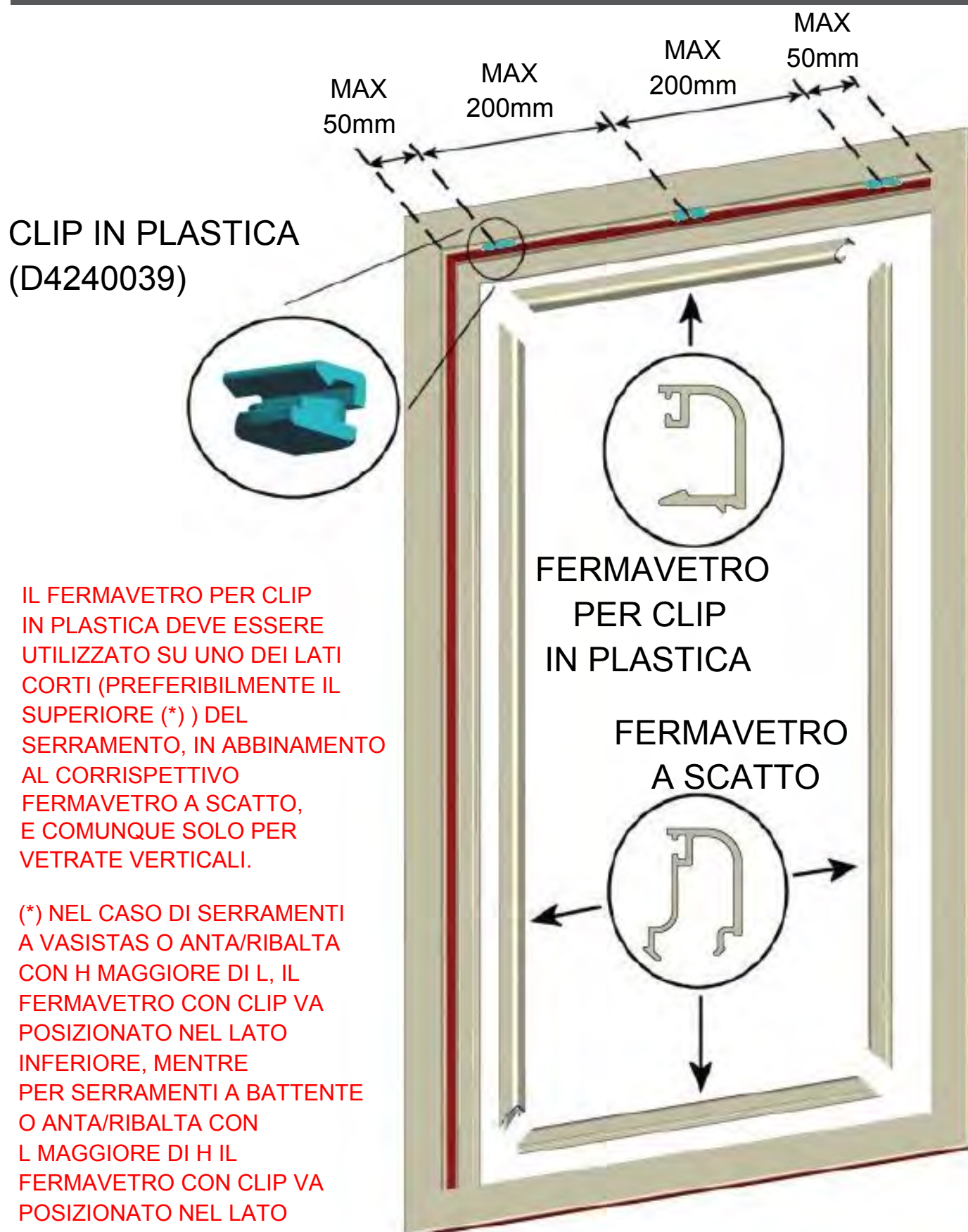



IL FERMAVETRO PER CLIP IN PLASTICA DEVE ESSERE UTILIZZATO SU UNO DEI LATI CORTI (PREFERIBILMENTE IL SUPERIORE (*)) DEL SERRAMENTO, IN ABBINAMENTO AL CORRISPETTIVO FERMAVETRO A SCATTO, E COMUNQUE SOLO PER VETRATE VERTICALI.

(*) NEL CASO DI SERRAMENTI A VASISTAS O ANTA/RIBALTA CON H MAGGIORE DI L, IL FERMAVETRO CON CLIP VA POSIZIONATO NEL LATO INFERIORE, MENTRE PER SERRAMENTI A BATTENTE O ANTA/RIBALTA CON L MAGGIORE DI H IL FERMAVETRO CON CLIP VA POSIZIONATO NEL LATO CERNIERA.

TABELLA UTILIZZO FERMAVETRI

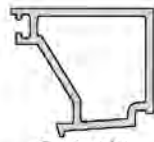
Applicazioni	Sollecitazioni & Rischi	Fermavetro		
		 Clip in plastica	 Scatto	 Contrasto
Serramenti esterni con il lato inferiore a meno di un metro dal piano di calpestio esterno	Urto dall'esterno che possa causare distacco della lastra e quindi danni a persone o cose.	NO	$S < 6m^2$	OK
Serramenti esterni con il lato inferiore oltre un metro dal piano di calpestio esterno	Possibilità di urto dall'esterno	$S < 2m^2$ $P < 100kg$	$S < 6m^2$	OK
Aperture esterne	Caduta del vetro nel vuoto	NO	OK	OK
Vetrine e porte interne ed esterne con il lato inferiore a meno di un metro dal piano di calpestio esterno	Urto dall'esterno che possa causare distacco della lastra e quindi danni a persone o cose.	NO	NO	OK
Asili, scuole, ospedali, ambienti comuni di edifici residenziali	Possibilità di urto dall'esterno	NO	NO	OK
Applicazioni con inclinazione rispetto al piano verticale superiore a 15°	Caduta del vetro nel vuoto	NO	NO	OK
Serramenti posti a protezione di oggetti di valore o socialmente pericolosi	Colpi dovuti ad atti vandalici o tentativi di effrazione che possano causare distacco della lastra e quindi danni a persone o cose.	NO	NO	OK (*)
Partizioni di stadi, palazzi dello sport, ecc.	Colpi dovuti ad atti vandalici o tentativi di effrazione che possano causare distacco della lastra e quindi danni a persone o cose.	NO	NO	OK

(*): i fermavetri a contrasto Domal non possiedono certificazioni all'antieffrazione, comunque la loro installazione è consigliata nel caso di porte e vetrine.

Aggiornamento 23/07/2015

● Tabellone Domal Top TB 65 Finestre

- sono stati inseriti i sottoriportati profilati.

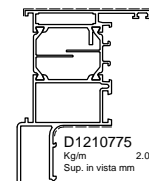
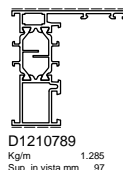
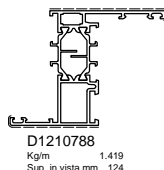
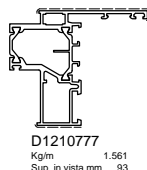
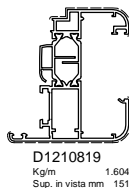
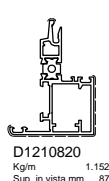

● Tabellone Domal Top TB 65 Porte

- è stato inserito il sottoriportato profilato.

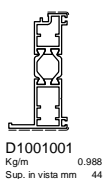

● Tabellone Domal Wood PA 100

- è stato inserito il sottoriportato profilato.

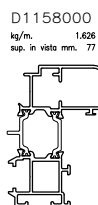

● Tabellone Domal Sunny

- sono stati tolti i sottoriportati profilati.

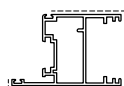

D3260176
sup.vista mm. 111
Kg./m 0.934
TAPPO D0030027

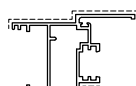

D3260177
sup.vista mm. 140
Kg./m 1.056
TAPPO D0030027



AGGIORNAMENTI TABELLONI DOMAL



Aggiornamento 22/06/2015

- **Tabellone Domal Mirror E52**
 - sono stati inseriti i profilati delle versioni Domal Mirror IT NS e SGC.



AGGIORNAMENTI TABELLONI DOMAL



Aggiornamento 26/03/2015

- Tabellone Domal Slide C160

- è stato inserito il Tabellone Domal Slide C160.

- Tabellone Domal Mirror E52

- è stato inserito il Tabellone Domal Mirror E52.



AGGIORNAMENTI TABELLONI DOMAL



Aggiornamento 05/02/2015

- **Tabellone Masselli Wood**

- è stato aggiornato il Tabellone Masselli Wood con l'inserimento dei nuovi masselli con linea squadrata.

Aggiornamento & %/2014

- Tabellone Domal ; UfXYb

- E stato aggiornato il tabellone Domal Garden rimuovendo i profilati relativi alla versione a taglio termico (vecchia Garden PA) definitivamente dismessa ed eliminata dall'offerta Domal.

Aggiornamento \$&/0+/2014

- Tabellone Domal K ccX'A UggY`]

- è stato inserito il $\text{c}^{\text{a}} \wedge || [\} \wedge \text{A} \ddot{O} [\{ \text{a} \wedge \text{a} \wedge \text{a} \} \text{a} \cdot \wedge || \text{a} \wedge \text{A} \wedge * \} [\text{A} \wedge || \wedge \text{A} \wedge | \text{a} \wedge \text{A} [[\text{a}$

Aggiornamento 26/05/2014

- **Tabellone Domal Sunny**

- corretti i pesi delle due ante **D3260184** (1,345 kg/m)
e **D3260057** (1,338 kg/m)

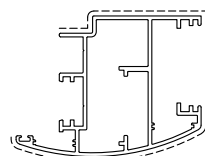

D3260184
sup.vista mm. 150
Kg./m 1.345
TAPPO D013D100

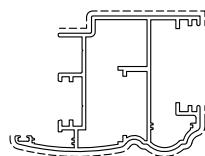

D3260057
sup.vista mm. 161
Kg./m 1.338
TAPPO D4240012

Aggiornamento 18/04/2014

- **Tabellone Domal Indoor**

- la squadretta L-ITLM046710 per l'anta **D3B20006** è stata ricodificata come **D4354000**

N.B. NON LAVORABILE CON LA
PUNZONATRICE DI SISTEMA.
CERNIERA D6210095
SQUADRETTA D4354000

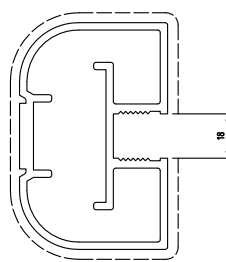

D3B20006

sup.vista mm. 136

Kg./m 0.828

Aggiornamento 24/02/2014

● Tabellone Domal TOP TB 65

- è stato inserito il telaio **D1210762** per abbinamento ai coprifilo tramite clip in acciaio D4280027

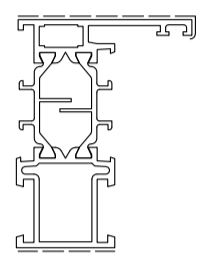

D1210762
Kg/m 1.263
Sup. in vista mm 82

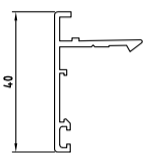

D3074007
kg/m. 0.325
sup. in vista mm. 49
CLIP D4280027

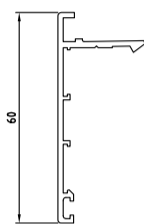

D3074006
kg/m. 0.416
sup. in vista mm. 69
CLIP D4280027

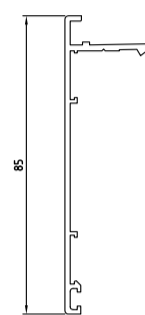

D3074009
kg/m. 0.517
sup. in vista mm. 94
CLIP D4280027

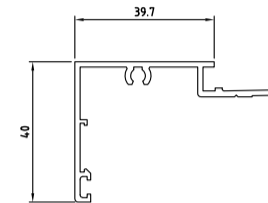

D3074008
kg/m. 0.549
sup. in vista mm. 84
CLIP D4280027

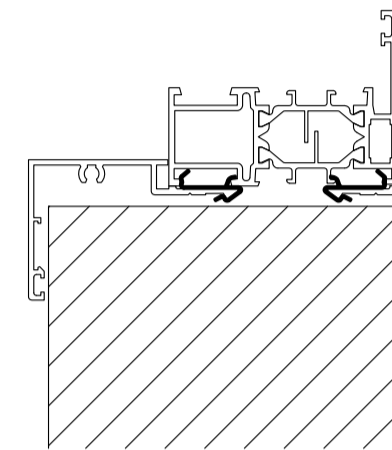

- sono stati inseriti i profilati **D1210786** (telaio L), **D1210787** (telaio Z) e **D1210818** (anta) della soluzione "SFERA"

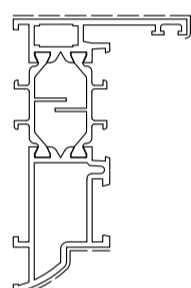

D1210786
Kg/m 1.303
Sup. in vista mm 89

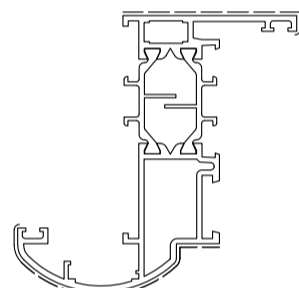

D1210787
Kg/m 1.549
Sup. in vista mm 129

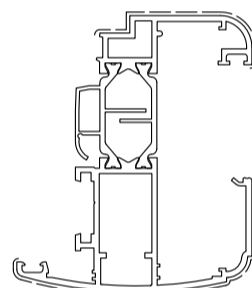

D1210818
Kg/m 1.693
Sup. in vista mm 158

- sono stati inseriti i profilati **D1210836** (riporto) e **D1210837** (anta) della soluzione apertura a bilico

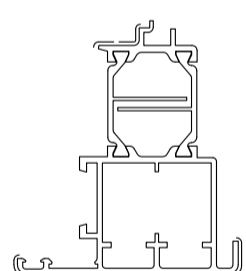

D1210836
Kg/m 1.387
Sup. in vista mm 92

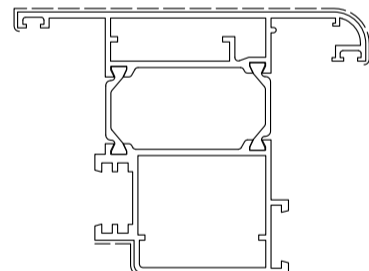

D1210837
Kg/m 2.088
Sup. in vista mm 178

● Tabellone Domal Sunny SpeedyFly

- è stato modificato il compensatore **D3260266** per inserimento a scatto

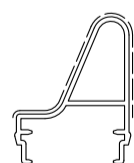

D3260266
Kg/m 0.452
Sup. in vista mm 76
TAPPO D4240172

● Tabellone Domal Sunny SpeedyFly

- è stata modificata l'anta **D3260184** per inserimento a scatto

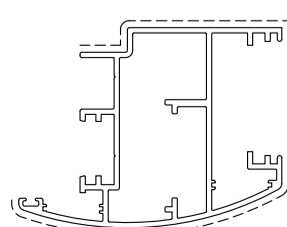

D3260184
sup. vista mm. 150
Kg./m 1.326
TAPPO D013D100

Aggiornamento 31/07/2013

● Tabellone Domal SUNNY

- è stata inserito il telaio persiana **D3B60016**

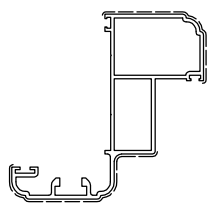

D3B60016
sup.vista mm. 147
Kg./m 1248

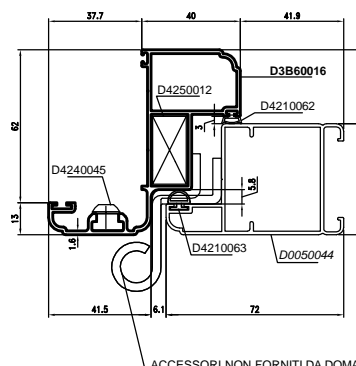

N.B.:

le cerniere non sono fornite da Domal

● Tabelloni Domal WOOD 85, WOOD PA 85 e WOOD SLIDE PA 180

- è stato corretto il disegno del profilo **D0062511** con l'aggiunta di due scatti
- esso sostituisce inoltre il D3290204 nel Wood Slide PA 180



D0062511
kg/m. 0.259
sup. in vista mm. =

● Tabelloni Domal TOP TB 65, Stopper PG, Slide 80-PA80, Slide 56

- sono stati corretti gli abbinamenti con i tappi per i seguenti profili



D3290217
Kg/m 0.302
Sup. in vista mm 22
TAPPO D4240168



D3290218
Kg/m 0.442
Sup. in vista mm 34
TAPPO D4240168

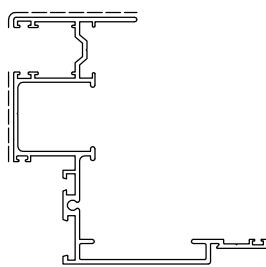

D3210190
sup.vista mm. 151
Kg./m 1801
TAPPO D4240117

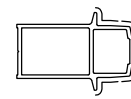

D3240065
kg/m. 0.643
Sup. in vista mm. 58
TAPPO D4240273



D0015175
sup.vista mm. 79
Kg/m 5369
NESSUN TAPPO

Aggiornamento 07/06/2013

- Tabellone Domal SUNNY IDEAL GELOSIA

- è stata inserita la fascia **D0050039**

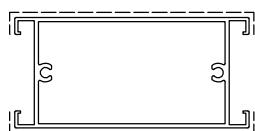

D0050039
sup. vista mm. 218
Kg./m 1,425

- Tabellone Domal GARDEN TB 75

- sono stati inseriti il riporto per ante pari **D1250015** e per porte **D1250012**

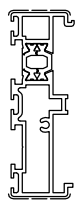

D1250015
Kg/m 1,238
Sup. in vista mm 48
TAPPO D4240276

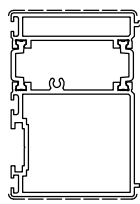

D1250012
Kg/m 1,806
Sup. in vista mm 102
TAPPO D4240275

Aggiornamento 15/05/2013

● Tabellone Domal TOP TB 65

- è stata inserita l'anta **D1001000** per porte complanari su vie di fuga

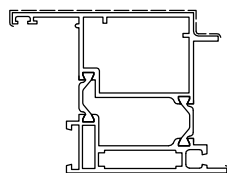

D1001000
Kg/m 2.045
Sup. in vista mm 164
TAPPO D4260266

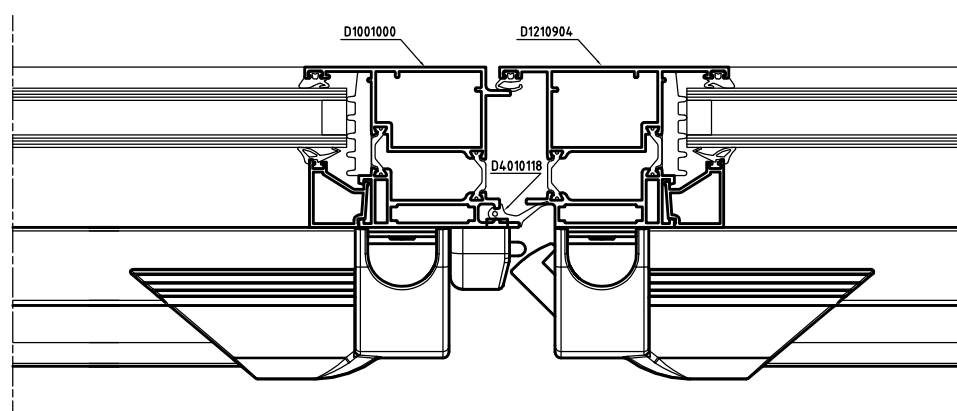

Aggiornamento 09/05/2013

● Tabellone Domal INDOOR

- è stata inserita l'anta **L-IT34642** per vetro con apertura 12mm

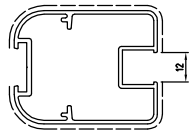

L-IT34642
sup.vista mm. 167
Kg./m 1.064

● Tabellone Domal SLIDE TB 65

- sono stati inseriti i seguenti coprifilo da fissare a telaio tramite la clip in acciaio **D4280027**

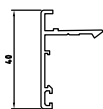

D3074007
kg/m. 0.325
sup. in vista mm. 49
CLIP D4280027

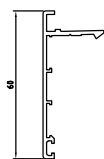

D3074006
kg/m. 0.416
sup. in vista mm. 69
CLIP D4280027

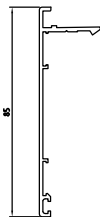

D3074009
kg/m. 0.517
sup. in vista mm. 94
CLIP D4280027

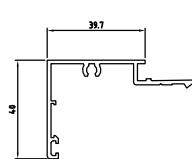

D3074008
kg/m. 0.549
sup. in vista mm. 84
CLIP D4280027

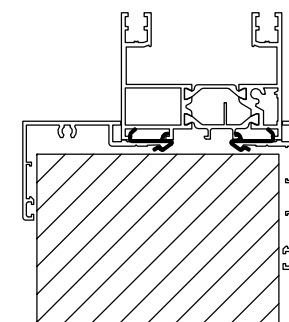

● Tabellone Domal SUNNY

- è stata inserita la lamella **D0026216** (per area NORD-EST) da utilizzare con i KIT D00BBK00, D00BBK01, D00BBK03

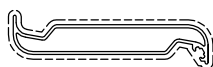

D0026216
sup.vista mm. 202
Kg./m 0.624
PER KIT
D00BBK00 - D00BBK01 - D00BBK03

● Tabellone Domal SUNNY MT

- è stato corretto il codice della lamella L-IT06809 in **D3032000**



D3032000
sup.vista mm. 148
Kg./m 0.506

Aggiornamento 18/03/2013

- **Tabellone Domal 40**

- sono stati corretti i codici degli articoli ***D3210261*** e ***D3210262***,
in precedenza invertiti

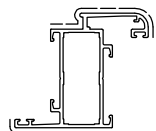

D3210261

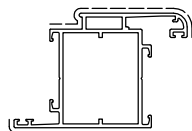

D3210262