



COMUNELLO
FRAME DIVISION

Life
made
easy

PULL HANDLES









GENERAL CATALOGUE



Life made easy

COMUNELLO FRAME DIVISION

LEGENDA

	Articolo / Article
	Diametro maniglione / Pull handle diameter
	Misura maniglione quadrato / Square handle size
	Materiale / Material
	Materiale maniglione / Pull handle material
	Finitura / Finishing
	Pezzi per confezione / Pieces per pack
	Peso confezione / Weight of pack
	Prezzo / Price

Finitura acciaio Inox *Finishing stainless steel*

009	Lucida / Polished - 24H
010	Satinata / Satin - 24H
015	PVD oro lucido / Polished gold PVD - 24H
105	PVD oro satinato / Satin gold <i>Su richiesta / On request</i>
110	PVD nickel lucido / Polished nickel PVD <i>Su richiesta / On request</i>
115	PVD nickel satinato / Satin nickel PVD <i>Su richiesta / On request</i>
120	PVD bronzo lucido / Polished bronze <i>Su richiesta / On request</i>
125	PVD bronzo satinato / Satin bronze <i>Su richiesta / On request</i>
130	PVD antracite lucido / Polished anthracite metal PVD <i>Su richiesta / On request</i>
135	PVD antracite satinato / Satin anthracite metal PVD <i>Su richiesta / On request</i>

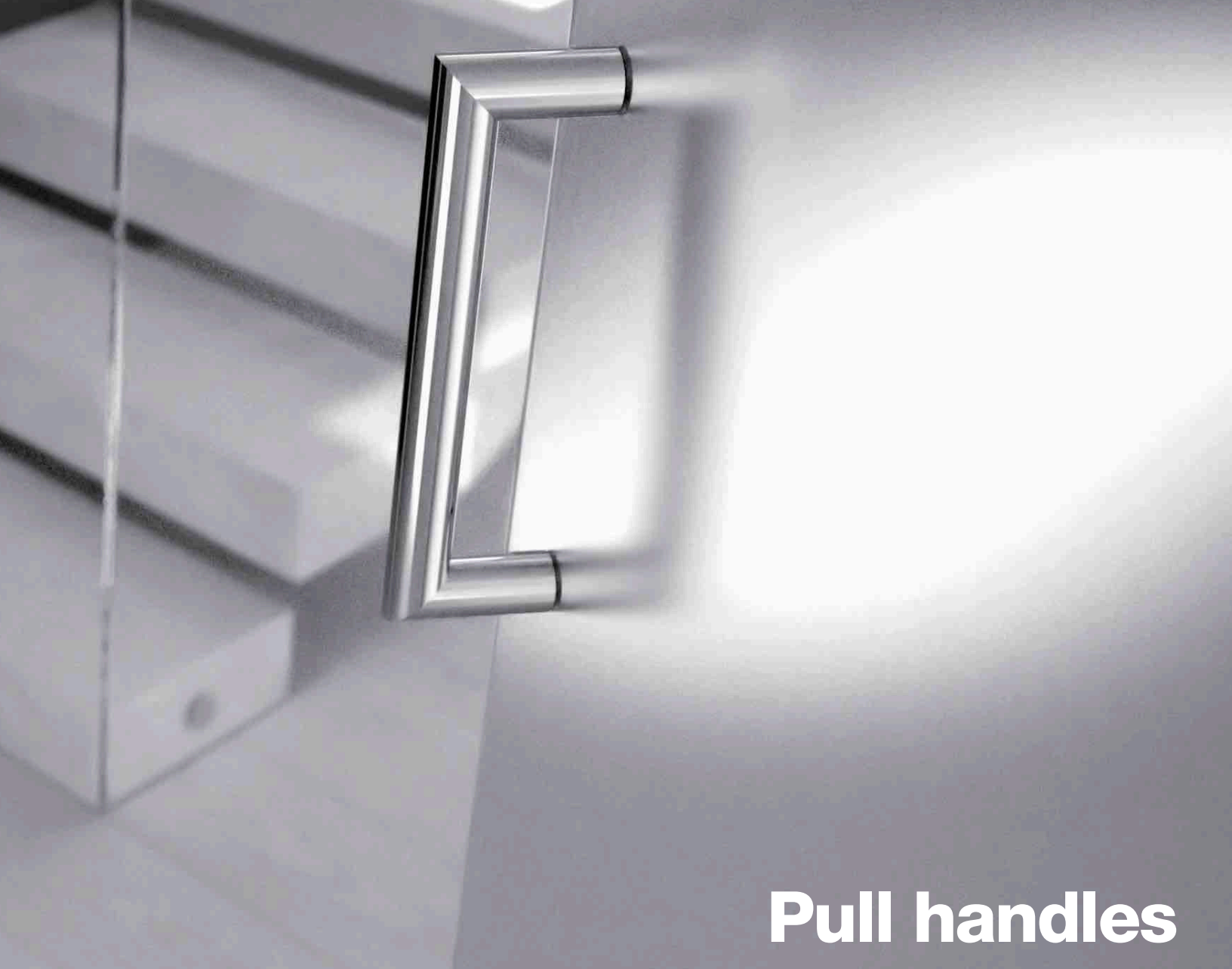

Pull handles



Finitura alluminio

Finishing aluminium

604	Anodizzato satinato argento / Anodized satined silver - 24H
503	Nero RAL / Black - 24H
607	Anodizzato argento brillantato / Anodized silver Su richiesta / On request
602	Anodizzato oro / Anodized gold Su richiesta / On request
603	Anodizzato bronzo / Anodized bronze Su richiesta / On request
9010	Bianco RAL / White Su richiesta / On request
3003	Rosso RAL / Red Su richiesta / On request
3007	Rosso RAL / Red Su richiesta / On request
8022	Marrone RAL / Brown Su richiesta / On request
5002	Azzurro RAL / Blue Su richiesta / On request
7035	Grigio RAL / Gray Su richiesta / On request
7016	Grigio antracite RAL / Anthracite gray Su richiesta / On request
6029	Verde RAL / Green Su richiesta / On request
5011	Giallo RAL / Yellow Su richiesta / On request

Finitura nylon

Finishing nylon

9010	Bianco RAL / White - 24H
9005	Nero RAL / Black - 24H



Ambidestro
ambidextrous
ambidextre
beidhändig

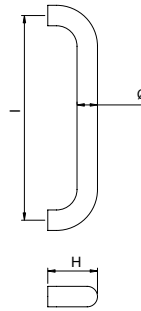

Fissaggi vedi pag. 204
Fixings - page 204
Fixations voir - page 204
Befestigung siehe - seite 204

2000 AL

CODICI 24 ORE			Ø	L	H		
2-0722-604	alluminio	argento satinato	20	200	60	2	0,4
2-0744-604	alluminio	argento satinato	25	300	70	2	0,7
2-0762-604	alluminio	argento satinato	30	230	85	2	0,7
2-0764-604	alluminio	argento satinato	30	300	85	2	0,9
2-0765-503	alluminio	nero	30	320	85	2	0,9
2-0766-604	alluminio	argento satinato	30	350	85	2	1,0
2-0782-503	alluminio	nero	35	350	85	2	1,2
2-0786-604	alluminio	argento satinato	35	650	85	2	1,9
2-0786-503	alluminio	nero	35	650	85	2	1,9

Categoria commerciale: 4E

SPECIALI			Ø	L	H
SP-2000-Ø-I	Alluminio	Verniciato	su richiesta	su richiesta	su richiesta
SP-2000-Ø-I	Alluminio	Anodizzato	su richiesta	su richiesta	su richiesta

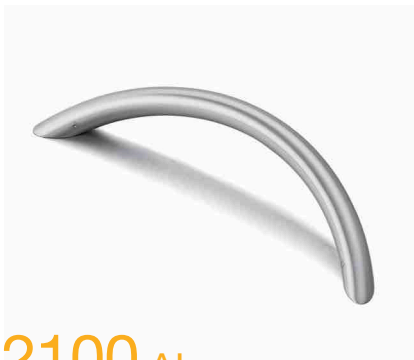

Ambidestro
ambidextrous
ambidextre
beidhändig

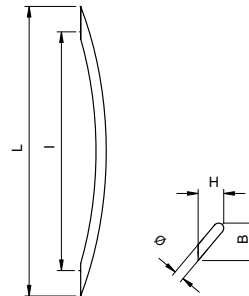

Fissaggi vedi pag. 204
Fixings - page 204
Fixations voir - page 204
Befestigung siehe - seite 204

2100 AL

CODICI 24 ORE			Ø	L	H	B		
2-1763-604	alluminio	argento satinato	30	350	75	110	2	1,2
2-1767-604	alluminio	argento satinato	30	700	75	110	2	1,9

Categoria commerciale: 4E



Ambidestro
ambidextrous
ambidextre
beidhändig

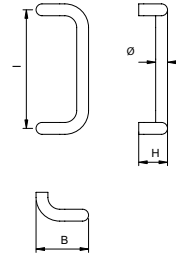

Fissaggi vedi pag. 204
Fixings - page 204
Fixations voir - page 204
Befestigung siehe - seite 204

2200 AL

CODICI 24 ORE			Ø	I	H	B		
2-2762-503	alluminio	nero	30	230	85	145	2	0,9
2-2762-604	alluminio	argento satinato	30	230	85	145	2	0,9
2-2764-604	alluminio	argento satinato	30	300	85	145	2	1,1
2-2764-503	alluminio	nero	30	300	85	145	2	1,1
2-2766-604	alluminio	argento satinato	30	350	85	145	2	1,2
2-2766-503	alluminio	nero	30	350	85	145	2	1,2
2-2782-604	alluminio	argento satinato	35	350	85	155	2	1,5
2-2782-503	alluminio	nero	35	350	85	155	2	1,5

Categoria commerciale: 4E

SPECIALI			Ø	I	H	B
SP-2200-Ø-I	Alluminio	Verniciato	su richiesta	su richiesta	su richiesta	su richiesta
SP-2200-Ø-I	Alluminio	Anodizzato	su richiesta	su richiesta	su richiesta	su richiesta

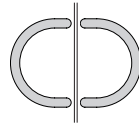

Ambidestro
ambidextrous
ambidextre
beidhändig

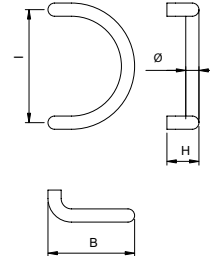

Fissaggi vedi pag. 204
Fixings - page 204
Fixations voir - page 204
Befestigung siehe - seite 204

2600 AL

CODICI 24 ORE			Ø	I	H	B		
2-6765-604	alluminio	argento satinato	30	300	85	225	2	1,2
2-6767-503	alluminio	nero	30	350	85	245	2	1,3
2-6783-604	alluminio	argento satinato	35	300	85	230	2	1,5
2-6783-503	alluminio	nero	35	300	85	230	2	1,5
2-6785-604	alluminio	argento satinato	35	350	85	260	2	1,7
2-6785-503	alluminio	nero	35	350	85	260	2	1,7

Categoria commerciale: 4E

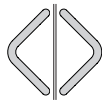

Ambidestro
ambidextrous
ambidextre
beidhändig

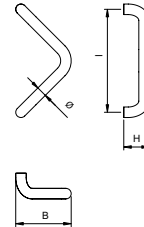

Fissaggi vedi pag. 204
Fixings - page 204
Fixations voir - page 204
Befestigung siehe - seite 204

2700 AL

CODICI 24 ORE			Ø	I	H	B		
2-7763-604	alluminio	argento satinato	30	300	85	159	2	1,0
2-7763-503	alluminio	nero	30	300	85	159	2	1,0
2-7765-604	alluminio	argento satinato	30	350	85	184	2	1,1
2-7765-503	alluminio	nero	30	350	85	184	2	1,1
2-7788-604	alluminio	argento satinato	35	425	85	226	2	1,6
2-7788-503	alluminio	nero	35	425	85	188	2	1,6

Categoria commerciale: 4E

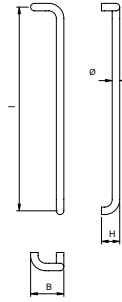
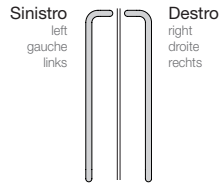

Fissaggi vedi pag. 204
Fixings - page 204
Fixations voir - page 204
Befestigung siehe - seite 204

2800 AL

CODICI 24 ORE			\varnothing	I	H	B		
2-8786-604 DX	alluminio	argento satinato	35	1200	85	155	1DX	1,7
2-8786-604 SX	alluminio	argento satinato	35	1200	85	155	1SX	1,7
2-8786-503 DX	alluminio	nero	35	1200	85	155	1DX	1,7
2-8786-503 SX	alluminio	nero	35	1200	85	155	1SX	1,7

Categoria commerciale: 4E

SPECIALI			\varnothing	I	H	B
SP-2800-Ø-I	Alluminio	Verniciato	su richiesta	su richiesta	su richiesta	su richiesta
SP-2800-Ø-I	Alluminio	Anodizzato	su richiesta	su richiesta	su richiesta	su richiesta

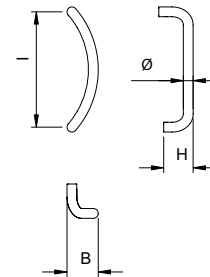
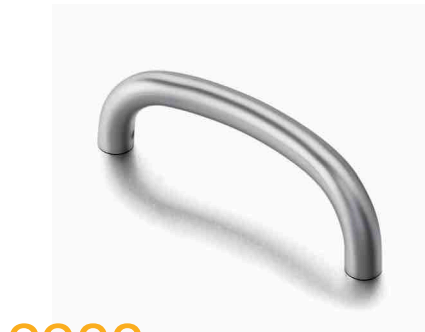

Fissaggi vedi pag. 204
Fixings - page 204
Fixations voir - page 204
Befestigung siehe - seite 204

2900 AL

CODICI 24 ORE			\varnothing	I	H	B		
2-9765-604	alluminio	argento satinato	30	350	85	98	2	1,0
2-9768-604	alluminio	argento satinato	30	500	85	98	2	1,3
2-9788-604	alluminio	argento satinato	35	500	85	98	2	1,6

Categoria commerciale: 4E

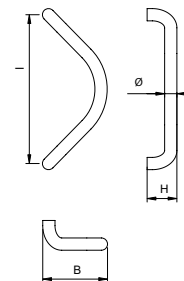

Fissaggi vedi pag. 204
Fixings - page 204
Fixations voir - page 204
Befestigung siehe - seite 204

2902 AL

CODICI 24 ORE			\varnothing	I	H	B		
2-9862-604	alluminio	argento satinato	30	300	85	180	2	1,0
2-9883-604	alluminio	argento satinato	35	350	85	185	2	1,4
2-9883-503	alluminio	nero	35	350	85	185	2	1,4

Categoria commerciale: 4E



Ambidestro
ambidextrous
ambidextre
beidhändig

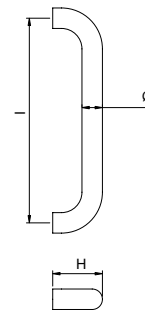

Fissaggi vedi pag. 204
Fixings - page 204
Fixations voir - page 204
Befestigung siehe - seite 204

2000 INOX

CODICI 24 ORE			Ø	L	H		
2-0122-010	inox/st-steel	satinato	20	200	60	2	0,7
2-0125-010	inox/st-steel	satinato	20	350	60	2	1,1
2-0144-009	inox/st-steel	lucido	25	300	70	2	1,2
2-0164-009	inox/st-steel	lucido	30	300	85	2	1,2
2-0164-010	inox/st-steel	satinato	30	300	85	2	1,2
2-0166-010	inox/st-steel	satinato	30	350	85	2	1,4
2-0182-010	inox/st-steel	satinato	35	350	85	2	1,6
2-0182-015	inox/st-steel	pvd	35	350	85	2	1,6
2-0186-010	inox/st-steel	satinato	35	650	85	2	2,5

Categoria commerciale: 4D

SPECIALI			Ø	L	H
SP-2000-Ø-I	Inox	Lucido	su richiesta	su richiesta	su richiesta
SP-2000-Ø-I	Inox	Satinato	su richiesta	su richiesta	su richiesta
SP-2000-Ø-I	Inox	PVD	su richiesta	su richiesta	su richiesta



Ambidestro
ambidextrous
ambidextre
beidhändig

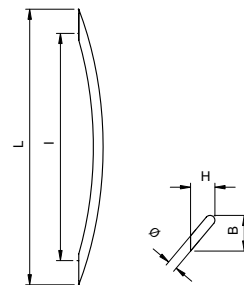

Fissaggi vedi pag. 204
Fixings - page 204
Fixations voir - page 204
Befestigung siehe - seite 204

2100 INOX

CODICI 24 ORE			Ø	L	L	H	B		
2-1147-010	inox/st-steel	satinato	25	700	849	75	106	2	2,9
2-1163-010	inox/st-steel	satinato	30	350	412	75	110	2	2,3
2-1163-015	inox/st-steel	pvd	30	350	412	75	110	2	2,3
2-1165-010	inox/st-steel	satinato	30	500	602	75	110	2	2,6
2-1165-015	inox/st-steel	pvd	30	500	602	75	110	2	2,6
2-1167-009	inox/st-steel	lucido	30	700	849	75	110	2	3,5
2-1167-010	inox/st-steel	satinato	30	700	849	75	110	2	3,5

Categoria commerciale: 4D

2200 INOX



Ambidestro
ambidextrous
ambidextre
beidhändig

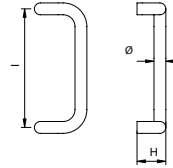

Fissaggi vedi pag. 204
Fixings - page 204
Fixations voir - page 204
Befestigung siehe - seite 204

CODICI 24 ORE			Ø	L	H	B		
2-2141-015	inox/st-steel	pvd	25	200	70	126	2	1,3
2-2146-010	inox/st-steel	satinato	25	350	70	126	2	1,7
2-2164-009	inox/st-steel	lucido	30	300	85	145	2	1,6
2-2164-010	inox/st-steel	satinato	30	300	85	145	2	1,6
2-2166-010	inox/st-steel	satinato	30	350	85	145	2	1,8
2-2182-010	inox/st-steel	satinato	35	350	85	145	2	2,0
2-2182-015	inox/st-steel	pvd	35	350	85	145	2	2,0
2-2186-010	inox/st-steel	satinato	35	650	85	145	2	3,0

Categoria commerciale: 4D

SPECIALI			Ø	L	H	B
SP-2200-Ø-I	Inox	Lucido	su richiesta	su richiesta	su richiesta	su richiesta
SP-2200-Ø-I	Inox	Satinato	su richiesta	su richiesta	su richiesta	su richiesta
SP-2200-Ø-I	Inox	PVD	su richiesta	su richiesta	su richiesta	su richiesta

2600 INOX

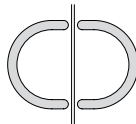

Ambidestro
ambidextrous
ambidextre
beidhändig

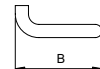
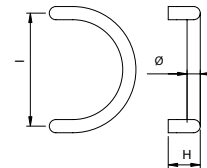

Fissaggi vedi pag. 204
Fixings - page 204
Fixations voir - page 204
Befestigung siehe - seite 204

CODICI 24 ORE			Ø	L	H	B		
2-6165-010	inox/st-steel	satinato	30	300	85	225	2	1,8
2-6165-015	inox/st-steel	pvd	30	300	85	225	2	1,8
2-6167-010	inox/st-steel	satinato	30	350	85	245	2	2,0
2-6183-010	inox/st-steel	satinato	35	300	85	230	2	2,0
2-6185-010	inox/st-steel	satinato	35	350	85	260	2	2,3
2-6185-015	inox/st-steel	pvd	35	350	85	260	2	2,3

Categoria commerciale: 4D

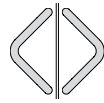

Ambidestro
ambidextrous
ambidextre
beidhändig

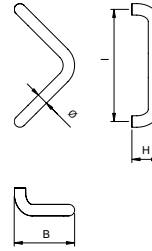

Fissaggi vedi pag. 204
Fixings - page 204
Fixations voir - page 204
Befestigung siehe - seite 204

2700 INOX

CODICI 24 ORE			\emptyset	I	H	B		
2-7163-010	inox/st-steel	satinato	30	300	85	159	2	1,4
2-7165-010	inox/st-steel	satinato	30	350	85	184	2	1,6
2-7185-010	inox/st-steel	satinato	35	350	85	188	2	1,9
2-7188-010	inox/st-steel	satinato	35	425	85	226	2	2,2

Categoria commerciale: 4D



Sinistro
left
gauche
links

Destro
right
droite
rechts

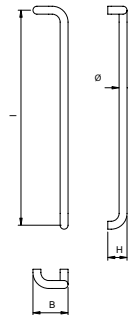
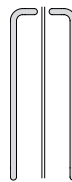

Fissaggi vedi pag. 204
Fixings - page 204
Fixations voir - page 204
Befestigung siehe - seite 204

2800 INOX

CODICI 24 ORE			\emptyset	I	H	B		
2-8166-010 DX	inox/st-steel	satinato	30	1200	85	145	1DX	2,0
2-8166-010 SX	inox/st-steel	satinato	30	1200	85	145	1SX	2,0
2-8186-010 DX	inox/st-steel	satinato	35	1200	85	155	1DX	2,3
2-8186-010 SX	inox/st-steel	satinato	35	1200	85	155	1SX	2,3

Categoria commerciale: 4D

SPECIALI			\emptyset	I	H	B
SP-2800-Ø-I	Inox	Lucido	su richiesta	su richiesta	su richiesta	su richiesta
SP-2800-Ø-I	Inox	Satinato	su richiesta	su richiesta	su richiesta	su richiesta
SP-2800-Ø-I	Inox	PVD	su richiesta	su richiesta	su richiesta	su richiesta



Ambidestro
ambidextrous
ambidextre
beidhändig

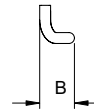
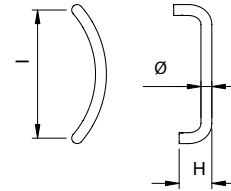

Fissaggi vedi pag. 204
Fixings - page 204
Fixations voir - page 204
Befestigung siehe - seite 204

2900 INOX

CODICI 24 ORE			\varnothing	I	H	B		
2-9165-010	inox/st-steel	satinato	30	350	85	98	2	1,5
2-9185-010	inox/st-steel	satinato	35	350	85	103	2	1,6

Categoria commerciale: 4D

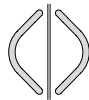

Ambidestro
ambidextrous
ambidextre
beidhändig

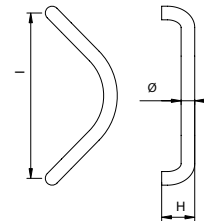

Fissaggi vedi pag. 204
Fixings - page 204
Fixations voir - page 204
Befestigung siehe - seite 204

2902 INOX

CODICI 24 ORE			\varnothing	I	H	B		
2-9262-010	inox/st-steel	satinato	30	300	85	180	2	1,6
2-9265-010	inox/st-steel	satinato	30	425	85	180	2	1,8
2-9283-009	inox/st-steel	lucido	35	350	85	185	2	1,9
2-9283-010	inox/st-steel	satinato	35	350	85	185	2	1,9
2-9283-015	inox/st-steel	pvd	35	350	85	185	2	1,9

Categoria commerciale: 4D

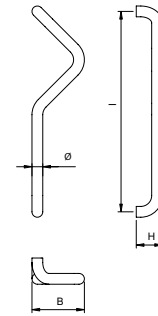
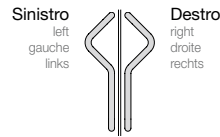

Fissaggi vedi pag. 204
Fixings - page 204
Fixations voir - page 204
Befestigung siehe - seite 204

3000 INOX

CODICI 24 ORE			Ø	L	H	B		
3-0166-010 DX	inox/st-steel	satinato	30	650	85	165	1	1,2
3-0166-010 SX	inox/st-steel	satinato	30	650	85	170	1	1,2

Categoria commerciale: 4D

SPECIALI			Ø	L	H	B
SP-3000-Ø-I	Inox	Lucido	su richiesta	su richiesta	su richiesta	su richiesta
SP-3000-Ø-I	Inox	Satinato	su richiesta	su richiesta	su richiesta	su richiesta
SP-3000-Ø-I	Inox	PVD	su richiesta	su richiesta	su richiesta	su richiesta

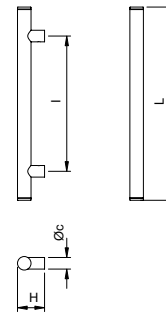
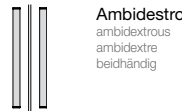

Fissaggi vedi pag. 204
Fixings - page 204
Fixations voir - page 204
Befestigung siehe - seite 204

4000 INOX

CODICI 24 ORE			Ø	L	L	H	Øc		
4-0042-009	inox/st-steel	lucido	25	300	450	70	25	1	1,7
4-0042-010	inox/st-steel	satinato	25	300	450	70	25	2	1,7
4-0064-010	inox/st-steel	satinato	30	350	500	75	25	2	2,2
4-0066-010	inox/st-steel	satinato	30	500	650	75	25	2	2,7
4-0068-010	inox/st-steel	satinato	30	650	800	75	25	2	3,3

Categoria commerciale: 4D

SPECIALI			Ø	L	L	H	B	Øc
SP-4000-Ø-I	Inox	Lucido	su richiesta	su richiesta	su richiesta	su richiesta	su richiesta	su richiesta
SP-4000-Ø-I	Inox	Satinato	su richiesta	su richiesta	su richiesta	su richiesta	su richiesta	su richiesta
SP-4000-Ø-I	Inox	PVD	su richiesta	su richiesta	su richiesta	su richiesta	su richiesta	su richiesta

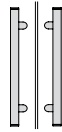

Ambidestro
ambidextrous
ambidextre
beidhändig

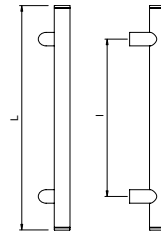

Fissaggi vedi pag. 204
Fixings - page 204
Fixations voir - page 204
Befestigung siehe - seite 204

4010 INOX

CODICI 24 ORE			Ø	I	L	H	Øc	B		
4-0164-010	inox/st-steel	satinato	30	350	500	75	25	54	2	2,6
4-0168-010	inox/st-steel	satinato	30	650	800	75	25	54	2	3,7
4-0185-010	inox/st-steel	satinato	35	500	650	80	30	54	2	3,5

Categoria commerciale: 4D

SPECIALI			Ø	I	L	H	Øc	B
SP-4010-Ø-I	Inox	Lucido	su richiesta	su richiesta	su richiesta	su richiesta	su richiesta	su richiesta
SP-4010-Ø-I	Inox	Satinato	su richiesta	su richiesta	su richiesta	su richiesta	su richiesta	su richiesta
SP-4010-Ø-I	Inox	PVD	su richiesta	su richiesta	su richiesta	su richiesta	su richiesta	su richiesta

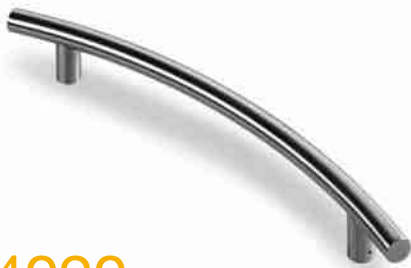

Ambidestro
ambidextrous
ambidextre
beidhändig

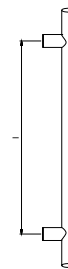

Fissaggi vedi pag. 204
Fixings - page 204
Fixations voir - page 204
Befestigung siehe - seite 204

4020 INOX

CODICI 24 ORE			Ø	I	L	H		
4-2065-010	inox/st-steel	satinato	30	450	600	75	2	1,6
4-2087-010	inox/st-steel	satinato	30	550	700	75	2	1,8

Categoria commerciale: 4D

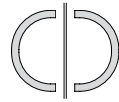

Ambidestro
ambidextrous
ambidextre
beidhändig

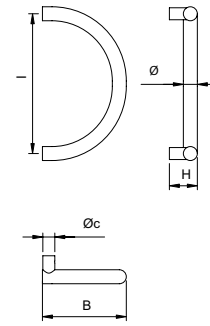

Fissaggi vedi pag. 204
Fixings - page 204
Fixations voir - page 204
Befestigung siehe - seite 204

4300 INOX

CODICI 24 ORE			\varnothing	I	H	\varnothing_c	B		
4-3064-010	inox/st-steel	satinato	30	300	75	25	175	2	2,0
4-3085-010	inox/st-steel	satinato	35	350	80	30	210	2	2,7

Categoria commerciale: 4D



Ambidestro
ambidextrous
ambidextre
beidhändig

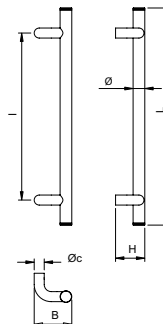

Fissaggi vedi pag. 204
Fixings - page 204
Fixations voir - page 204
Befestigung siehe - seite 204

4400 INOX

CODICI 24 ORE			\varnothing	I	L	H	\varnothing_c	B		
4-4062-009	inox/st-steel	lucido	30	350	500	85	25	108	2	2,5
4-4062-010	inox/st-steel	satinato	30	350	500	85	25	108	2	2,5
4-4064-010	inox/st-steel	satinato	30	500	650	85	25	108	2	3,1
4-4082-010	inox/st-steel	satinato	35	350	500	88	30	113	2	3,0
4-4084-010	inox/st-steel	satinato	35	500	650	88	30	113	2	3,6
4-4088-010	inox/st-steel	satinato	35	900	1050	88	30	113	2	5,2

Categoria commerciale: 4D

SPECIALI			\varnothing	I	L	H	B
SP-4400-Ø-I	Inox	Lucido	su richiesta	su richiesta	su richiesta	su richiesta	su richiesta
SP-4400-Ø-I	Inox	Satinato	su richiesta	su richiesta	su richiesta	su richiesta	su richiesta
SP-4400-Ø-I	Inox	PVD	su richiesta	su richiesta	su richiesta	su richiesta	su richiesta

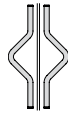

Ambidestro
ambidextrous
ambidextre
beidhändig

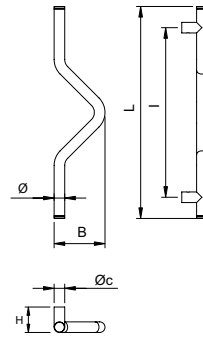

Fissaggi vedi pag. 204
Fixings - page 204
Fixations voir - page 204
Befestigung siehe - seite 204

4802 INOX

CODICI 24 ORE			\varnothing	I	L	H	\varnothing_c	B		
4-8244-010	inox/st-steel	satinato	25	400	500	70	25	120	2	2,1

Categoria commerciale: 4D

SPECIALI			\varnothing	I	L	H	\varnothing_c	B
SP-4802-Ø-I	Inox	Lucido	su richiesta	su richiesta	su richiesta	su richiesta	su richiesta	su richiesta
SP-4802-Ø-I	Inox	Satinato	su richiesta	su richiesta	su richiesta	su richiesta	su richiesta	su richiesta
SP-4802-Ø-I	Inox	PVD	su richiesta	su richiesta	su richiesta	su richiesta	su richiesta	su richiesta

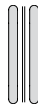
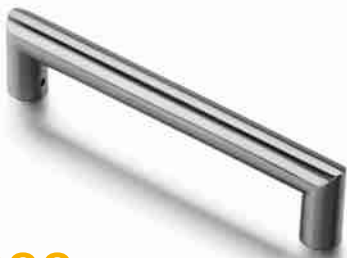

Ambidestro
ambidextrous
ambidextre
beidhändig

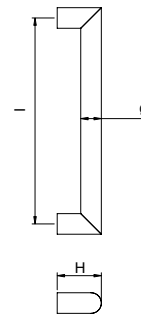

Fissaggi vedi pag. 204
Fixings - page 204
Fixations voir - page 204
Befestigung siehe - seite 204

5000 INOX

CODICI 24 ORE			\varnothing	I	H		
5-0025-010	inox/st-steel	satinato	20	350	60	2	1,0
5-0045-010	inox/st-steel	satinato	25	300	65	2	1,0
5-0085-010	inox/st-steel	satinato	35	350	75	2	1,6

Categoria commerciale: 4D

SPECIALI			\varnothing	I	H
SP-5000-Ø-I	Inox	Lucido	su richiesta	su richiesta	su richiesta
SP-5000-Ø-I	Inox	Satinato	su richiesta	su richiesta	su richiesta
SP-5000-Ø-I	Inox	PVD	su richiesta	su richiesta	su richiesta

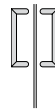

Ambidestro
ambidextrous
ambidextre
beidhändig

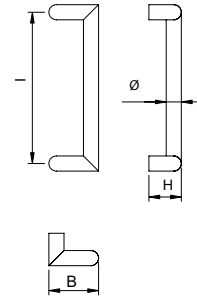

Fissaggi vedi pag. 204
Fixings - page 204
Fixations voir - page 204
Befestigung siehe - seite 204

5200 INOX

CODICI 24 ORE			\emptyset	I	H	B		
5-2046-010	inox/st-steel	satinato	25	350	65	65	2	1,4
5-2066-010	inox/st-steel	satinato	30	350	70	70	2	1,8
5-2086-010	inox/st-steel	satinato	35	350	75	75	2	2,2

Categoria commerciale: 4D

SPECIALI			\emptyset	I	H	B
SP-5200-Ø-I	Inox	Lucido	su richiesta	su richiesta	su richiesta	su richiesta
SP-5200-Ø-I	Inox	Satinato	su richiesta	su richiesta	su richiesta	su richiesta
SP-5200-Ø-I	Inox	PVD	su richiesta	su richiesta	su richiesta	su richiesta

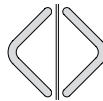

Ambidestro
ambidextrous
ambidextre
beidhändig

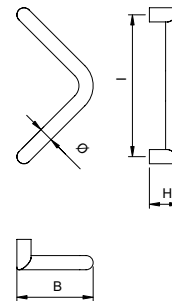

Fissaggi vedi pag. 204
Fixings - page 204
Fixations voir - page 204
Befestigung siehe - seite 204

5300 INOX

CODICI 24 ORE			\emptyset	I	H		
5-3085-010	inox/st-steel	satinato	35	350	75	2	1,8

Categoria commerciale: 4D

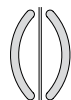

Ambidestro
ambidextrous
ambidextre
beidhändig

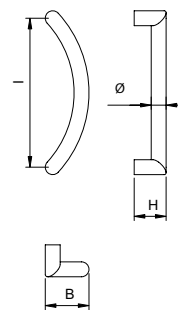

Fissaggi vedi pag. 204
Fixings - page 204
Fixations voir - page 204
Befestigung siehe - seite 204

5400 INOX

CODICI 24 ORE			Ø	I	H	B		
5-4043-010	inox/st-steel	satinato	25	250	60	64	2	1,0
5-4062-010	inox/st-steel	satinato	30	300	70	78	2	1,4
5-4062-015	inox/st-steel	pvd	30	300	70	78	2	1,4
5-4065-009	inox/st-steel	lucido	30	350	70	84	2	1,6
5-4065-010	inox/st-steel	satinato	30	350	70	84	2	1,6
5-4068-010	inox/st-steel	satinato	30	600	70	145	2	2,6
5-4082-010	inox/st-steel	satinato	35	350	75	89	2	1,8
5-4082-015	inox/st-steel	pvd	35	350	75	89	2	1,8
5-4085-010	inox/st-steel	satinato	35	500	75	123	2	2,5
5-4088-010	inox/st-steel	satinato	35	700	75	148	2	3,3

Categoria commerciale: 4D

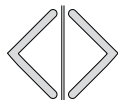

Ambidestro
ambidextrous
ambidextre
beidhändig

Fissaggi vedi pag. 204
Fixings - page 204
Fixations voir - page 204
Befestigung siehe - seite 204

5500 INOX

CODICI 24 ORE			Ø	I	H		
5-5063-010	inox/st-steel	satinato	30	300	70	2	1,6

Categoria commerciale: 4D



Ambidestro
ambidextrous
ambidextre
beidhändig

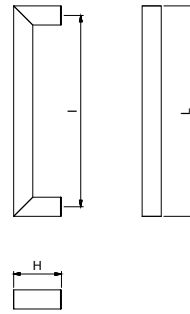

Fissaggi vedi pag. 204
Fixings - page 204
Fixations voir - page 204
Befestigung siehe - seite 204

7000 INOX

SU RICHIESTA								
7-0064-010	inox/st-steel	satinato	30	300	330	75	2	1,4
7-0086-010	inox/st-steel	satinato	30	650	680	75	2	2,6

Categoria commerciale: 4D

SPECIALI					
SP-7000-I	Inox	satinato	30	su richiesta	75

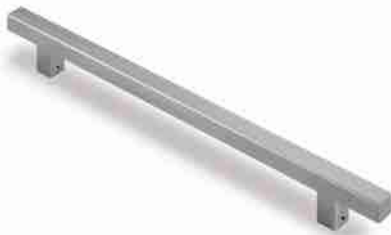

Ambidestro
ambidextrous
ambidextre
beidhändig

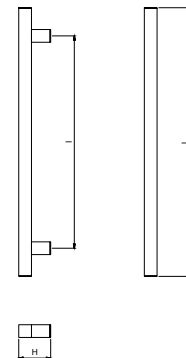

Fissaggi vedi pag. 204
Fixings - page 204
Fixations voir - page 204
Befestigung siehe - seite 204

7100 INOX

SU RICHIESTA								
7-1066-010	inox/st-steel	satinato	30	500	650	75	2	2,1

Categoria commerciale: 4D

SPECIALI					
SP-7100-I	Inox	satinato	30	su richiesta	75



Ambidestro
ambidextrous
ambidextre
beidhändig

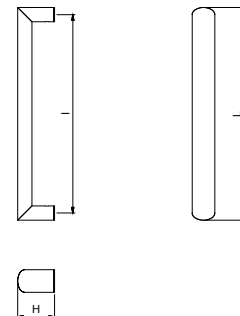

Fissaggi vedi pag. 199
Fixings - page 199
Fixations voir - page 199
Befestigung siehe - seite 199

8000 INOX

SU RICHIESTA								
8-0048-010	inox/st-steel	satinato	40x20	350	370	65	2	1,4
8-0086-010	inox/st-steel	satinato	40x20	650	670	65	2	2,1

Categoria commerciale: 4D

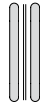

Ambidestro
ambidextrous
ambidextre
beidhändig

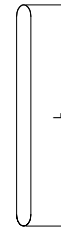

Fissaggi vedi pag. 199
Fixings - page 199
Fixations voir - page 199
Befestigung siehe - seite 199

8100 INOX



SU RICHIESTA								
8-1048-010	inox/st-steel	satinato	40x20	350	390	85	2	1,4
8-1086-010	inox/st-steel	satinato	40x20	650	690	85	2	2,1

Categoria commerciale: 4D



Ambidestro
ambidextrous
ambidextre
beidhändig

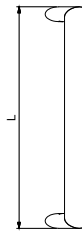

Fissaggi vedi pag. 199
Fixings - page 199
Fixations voir - page 199
Befestigung siehe - seite 199

8150 INOX

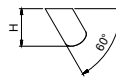

SU RICHIESTA								
8-1548-010	inox/st-steel	satinato	40x20	350	370	65	2	1,4
8-1586-010	inox/st-steel	satinato	40x20	650	670	65	2	2,1

Categoria commerciale: 4D

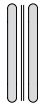

Ambidestro
ambidextrous
ambidextre
beidhändig

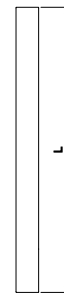

Fissaggi vedi pag. 199
Fixings - page 199
Fixations voir - page 199
Befestigung siehe - seite 199

8200 INOX



SU RICHIESTA								
8-2048-010	inox/st-steel	satinato	40x20	350	500	65	2	1,700
8-2087-010	inox/st-steel	satinato	40x20	550	700	65	2	2,200

Categoria commerciale: 4D

SPECIALI					
SP-8200-I	Inox	satinato	40x20	su richiesta	65



Ambidestro
ambidextrous
ambidextre
beidhändig

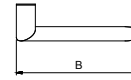
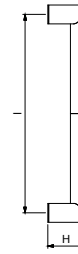
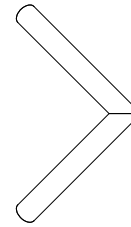

Fissaggi vedi pag. 199
Fixings - page 199
Fixations voir - page 199
Befestigung siehe - seite 199

8300 INOX

SU RICHIESTA								
8-3048-010	inox/st-steel	satinato	40x20	350	220	65	2	1,7
8-3088-010	inox/st-steel	satinato	40x20	425	255	65	2	2,0

Categoria commerciale: 4D



Ambidestro
ambidextrous
ambidextre
beidhändig

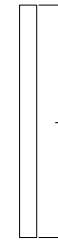
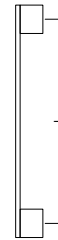

Fissaggi vedi pag. 199
Fixings - page 199
Fixations voir - page 199
Befestigung siehe - seite 199

9000 INOX

SU RICHIESTA								
9-0048-010	inox/st-steel	satinato	30x8	350	400	48	2	3,4
9-0087-010	inox/st-steel	satinato	30x8	550	600	48	2	4,2

Categoria commerciale: 4D



Ambidestro
ambidextrous
ambidextre
beidhändig

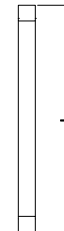

Fissaggi vedi pag. 199
Fixings - page 199
Fixations voir - page 199
Befestigung siehe - seite 199

9100 INOX

SU RICHIESTA								
9-1048-010	inox/st-steel	satinato	30x8	350	400	48	2	2,6
9-1087-010	inox/st-steel	satinato	30x8	550	600	48	2	3,4

Categoria commerciale: 4E

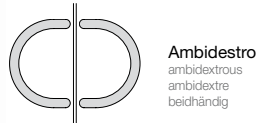

Ambidestro
ambidextrous
ambidextre
beidhändig

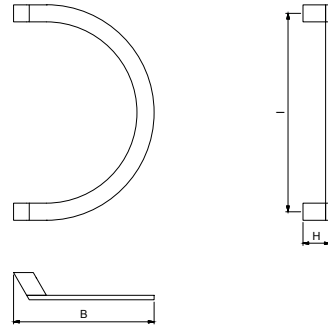

Fissaggi vedi pag. 204
Fixings - page 204
Fixations voir - page 204
Befestigung siehe - seite 204

9150 INOX

SU RICHIESTA								
9-1548-010	inox/st-steel	satinato	30x8	350	250	48	2	3,600

Categoria commerciale: 4D



Ambidestro
ambidextrous
ambidextre
beidhändig

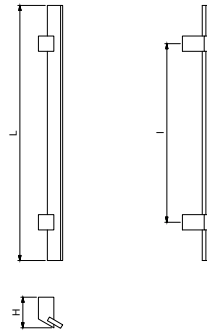

Fissaggi vedi pag. 204
Fixings - page 204
Fixations voir - page 204
Befestigung siehe - seite 204

9200 INOX

SU RICHIESTA								
9-2048-010	inox/st-steel	satinato	30x8	350	500	60	2	3,2
9-2087-010	inox/st-steel	satinato	30x8	550	700	60	2	4,0

Categoria commerciale: 4D

SPECIALI					
SP-9200-I	Inox	satinato	30x8	su richiesta	60



Ambidestro
ambidextrous
ambidextre
beidhändig

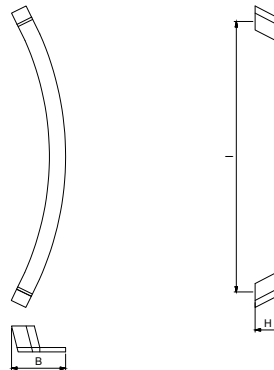

Fissaggi vedi pag. 204
Fixings - page 204
Fixations voir - page 204
Befestigung siehe - seite 204

9300 INOX

SU RICHIESTA								
9-3066-010	inox/st-steel	satinato	30x8	500	100	48	2	3,2
9-3089-010	inox/st-steel	satinato	30x8	700	110	48	2	4,0

Categoria commerciale: 4D

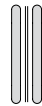

Ambidestro
ambidextrous
ambidextre
beidhändig

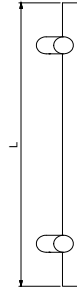

Fissaggi vedi pag. 204
Fixings - page 204
Fixations voir - page 204
Befestigung siehe - seite 204

9400 INOX

SU RICHIESTA								
9-4048-010	inox/st-steel	satinato	30x8	350	500	48	2	3,1
9-4087-010	inox/st-steel	satinato	30x8	550	700	48	2	3,9

Categoria commerciale: 4D

SPECIALI					
SP-9400-I	Inox	satinato	30x8	su richiesta	48

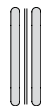

Ambidestro
ambidextrous
ambidextre
beidhändig

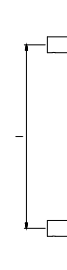

Fissaggi vedi pag. 204
Fixings - page 204
Fixations voir - page 204
Befestigung siehe - seite 204

9500 INOX

SU RICHIESTA								
9-5048-010	inox/st-steel	satinato	30x8	350	500	48	2	2,9
9-5087-010	inox/st-steel	satinato	30x8	550	700	48	2	3,7

Categoria commerciale: 4D



Ambidestro
ambidextrous
ambidextre
beidhändig



Fissaggi vedi pag. 204
Fixings - page 204
Fixations voir - page 204
Befestigung siehe - seite 204

9600 INOX

SU RICHIESTA								
9-6048-010	inox/st-steel	satinato	30	350	500	80	2	2,400
9-6087-010	inox/st-steel	satinato	30	550	700	80	2	2,700

Categoria commerciale: 4D



Ambidestro
ambidextrous
ambidextre
beidhändig

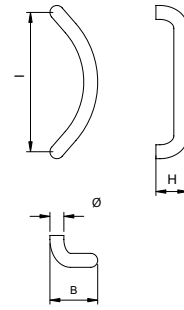

Fissaggi vedi pag. 204
Fixings - page 204
Fixations voir - page 204
Befestigung siehe - seite 204

6300 NYLON

CODICI 24 ORE								
6-3085-9005	nylon	nero	35	350	80	120	2	1,0

Categoria commerciale: 4H



Ambidestro
ambidextrous
ambidextre
beidhändig

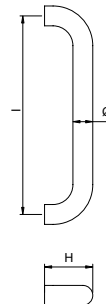

Fissaggi vedi pag. 204
Fixings - page 204
Fixations voir - page 204
Befestigung siehe - seite 204

6400 NYLON

CODICI 24 ORE							
6-4065-9005	nylon	nero	35	225	80	2	0,6
6-4085-9005	nylon	nero	30	350	80	2	1,1

Categoria commerciale: 4H



Ambidestro
ambidextrous
ambidextre
beidhändig

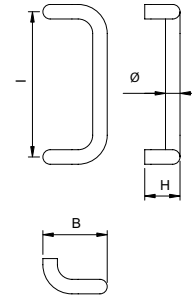

Fissaggi vedi pag. 204
Fixings - page 204
Fixations voir - page 204
Befestigung siehe - seite 204

6500 NYLON

CODICI 24 ORE								
6-5085-9005	nylon	nero	35	350	80	140	2	1,2
6-5085-9010	nylon	bianco	35	350	80	140	2	1,2

Categoria commerciale: 4H

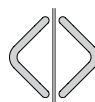

Ambidestro
ambidextrous
ambidextre
beidhändig

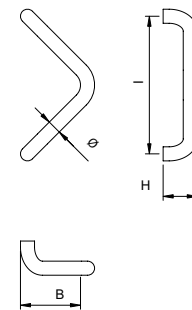







Fissaggi vedi pag. 204
Fixings - page 204
Fixations voir - page 204
Befestigung siehe - seite 204

6700 NYLON

CODICI 24 ORE								
6-7085-9005	nylon	nero	35	425	80	226	2	1,8

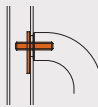
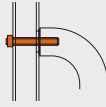
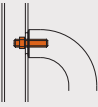
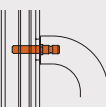
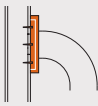
Categoria commerciale: 4H

		Ø Maniglione	Nylon	
PORTE IN VETRO Glass door / Glasstüren Puertas de vidrio / Portes en verre 	APPLICAZIONE SINGOLA Single application Einseitige Befestigung Aplicación simple Application single 	Ø 20mm Ø 25mm Ø 30mm Ø 35mm Altre sezioni	- - F0026 B/N F0028 B/N -	
	APPLICAZIONE DOPPIA Double application Paarweise Befestigung Aplicación doble Application double 	Ø 20mm Ø 25mm Ø 30mm Ø 35mm Altre sezioni	- - F1016 24H F1018 24H -	
PORTE CON PROFILO TUBOLARE Tubular profile Rohrprofile Puertas con perfil tubular Profils tubulaires 	APPLICAZIONE SINGOLA Single application Einseitige Befestigung Aplicación simple Application single 	Aggancio rapido Rapid installation Schnellkupplung Enganche rápido Attelage rapide 	Ø 20mm Ø 25mm Ø 30mm Ø 35mm Altre sezioni	- - F1116 24H F0068 24H -
	Foro passante con tappo Through hole with plug Durchgangsbohrung mit Stopfen Agujero pasante con tapón Trou passant avec bouchon 	Ø 20mm Ø 25mm Ø 30mm Ø 35mm Altre sezioni	- - F0046 F0048 24H -	
	A fresatura To be milled À fraisage Gefräst 	Ø 20mm Ø 25mm Ø 30mm Ø 35mm Altre sezioni	- - F0036 F0038 -	
	Tripla camera Three-chamber Tripelkammer Triple cámara Triple chambre 	Ø 20mm Ø 25mm Ø 30mm Ø 35mm Altre sezioni	- - - - -	
	Con placca With plate Mit Platte Con placa Avec rosace 	Ø 20mm Ø 25mm Ø 30mm Ø 35mm Altre sezioni	- - F0056 B/N F0058 B/N 24H -	
	APPLICAZIONE DOPPIA Double application Paarweise Befestigung Aplicación doble Application double 	Ø 20mm Ø 25mm Ø 30mm Ø 35mm Altre sezioni	- - F0016 24H F0018 24H -	

Alluminio	Inox	2100	Inox <small>SERIE 8000</small>
F7022 B/N	F1022 L/S/PVD	-	-
F7024 B/N	F1320 L/S/PVD	-	-
F7026 B/N	F1330 L/S/PVD 24H	-	-
F7028 B/N	F1335 L/S/PVD	-	-
-	-	-	-
F1012	F1012	-	-
F7014	F2001 24H	F1084	-
F7016 24H	F2001 24H	F7016	-
F7016 24H	F2001 24H	-	-
-	F2001 24H	-	F1012
-	-	-	-
F1112	F1112	-	-
F1114	F1000 24H	-	-
F1116 24H	F1000 24H	F1116 24H	-
F1116 24H	F1000 24H	-	-
-	F1000 24H	-	-
-	-	-	-
F1042	F1042	-	-
F7044	F1200 24H	-	-
F7046 24H	F1200 24H	F7046 24H	-
F7046 24H	F1200 24H	-	-
-	F1200 24H	-	F1042
-	-	-	-
F1032	F1042	-	-
F7044	F1200 24H	F1094	-
F7046	F1200 24H	F7036 24H	-
F7046	F1200 24H	-	-
-	F1200 24H	-	F1032
-	-	-	-
-	-	-	-
F1119	F1400	-	-
F1120	F1400	F1120	-
F1120	F1400	-	-
-	F1400	-	-
-	-	-	-
-	-	-	-
F7052 B/N	F1052 L/S/PVD	-	-
F7054 B/N	F3025 L/S/PVD	-	-
F7056 B/N/ANS	F3030 L/S/PVD 24H	-	-
F7056 B/N/ANS	F3035 L/S/PVD	-	-
-	-	-	-
-	-	-	-
F1012	F1012	-	-
F7014	F2000 24H	F1084	-
F7016 24H	F2000 24H	F7016 24H	-
F7016 24H	F2000 24H	-	-
-	F2000 24H	-	F1012

Finiture Finishing - Finitions - Ausführungen

BORCHIE SEMISFERICHE
Semispherical studs - Halbbrunde Zierplättchen -
Resbalones semiesféricos - Caches hémisphériques

- B:** Bianco / White
- N:** Nero / Black
- L:** Lucido / Polished
- S:** Satinato / Satin
- PVD:** PVD / Polished PVD



Finiture Finishing - Finitions - Ausführungen

PLACCHE
Door knob base rings - Abschlussringe - Placas -
Rosaces

- B:** Bianco / White
- N:** Nero / Black
- L:** Lucido / Polished
- S:** Satinato / Satin
- ANS:** Anod. argento sat. / Silver sat. anod.
- PVD:** PVD / Polished PVD



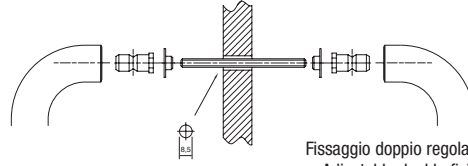

Fissaggio doppio regolabile per maniglioni in nylon su profili tubolari e porte in vetro
Adjustable double fixing for nylon pull-handles on tubular profiles and glass doors
Fixation double réglable pour poignées en nylon, sur profils tubulaires et portes en verre
Verstellbares Montageset paarweise für Nylonstosgriffe auf röhrenförmigen Profilen und Ganzglastüren

F001

F0016	30	nylon	1	0,4
Categoria commerciale: 4B				

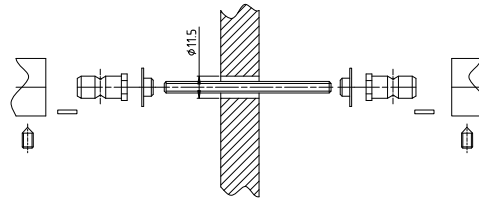

Fissaggio doppio regolabile per maniglioni in nylon su profili tubolari e porte in vetro
Adjustable double fixing for nylon pull-handles on tubular profiles and glass doors
Fixation double réglable pour poignées en nylon, sur profils tubulaires et portes en verre
Verstellbares Montageset paarweise für Nylonstosgriffe auf röhrenförmigen Profilen und Ganzglastüren

F0018

F0018	35	nylon	1	0,2
Categoria commerciale: 4B				

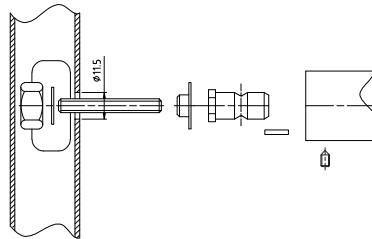

Fissaggio singolo a fresatura per profili tubolari
Single fixing by means of milling for tubular profiles
Fixation simple à fraisage pour profils tubulaires
Montageset einseitig zum Einfräsen für röhrenförmige Profile

F0038

F0038	35	nylon	1	0,1
Categoria commerciale: 4B				

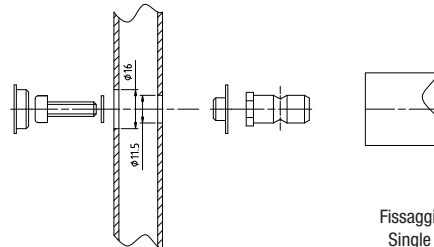

Fissaggio singolo per porte con profilo tubolare- Foro passante con tappo
Single attachment for doors with tubular profile - Through hole with cap
Einzelbefestigung für Türen mit Rohrprofil - durchgehende Bohrung mit Verschluss
Fixation simple pour portes avec profil tubulaire - Trou traversant avec bouchon

F0046

F0046	30	nylon	1	0,1
Categoria commerciale: 4B				

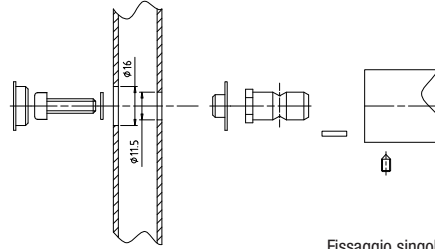

F0048

Fissaggio singolo per porte con profilo tubolare- Foro passante con tappo
Single attachment for doors with tubular profile - Through hole with cap
Einzelbefestigung für Türen mit Rohrprofil - durchgehende Bohrung mit Verschluss
Fixation simple pour portes avec profil tubulaire - Trou traversant avec bouchon

F0048	35	nylon	1	0,1

Categoria commerciale: 4B

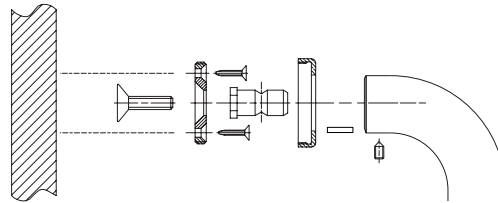

F0058N

Fissaggio singolo con placca in nylon per profili tubolari
Single fixing with nylon plate for tubular profiles
Fixation avec rosace en nylon pour profils tubulaires
Montageset einseitig mit Rosette aus Nylon für röhrenförmige Profile

F0058N	35	nylon	bianco - nero	1	0,1

Categoria commerciale: 4B

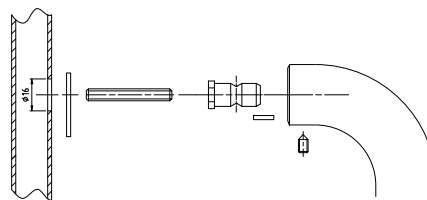

F0

Fissaggio singolo ad aggancio rapido per profili tubolari
Single fixing with fast hooking for tubular profiles
Fixation simple avec accrochage rapide pour profils tubulaires
Montageset einseitig mit schneller Kupplung für röhrenförmige Profile

F0068	35	nylon	1	0,850

Categoria commerciale: 4B

F1000

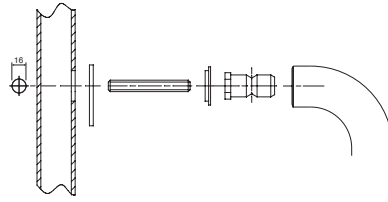

Fissaggio unificato singolo ad aggancio rapido per profili tubolari
 Single fixing with fast hooking for tubular profiles
 Fixation simple avec accrochage rapide pour profils tubulaires
 Montageset einseitig mit schneller Kupplung für röhrenförmige Profile

F1000	varie	inox	1	0,1
Categoria commerciale: 4B				

F1012

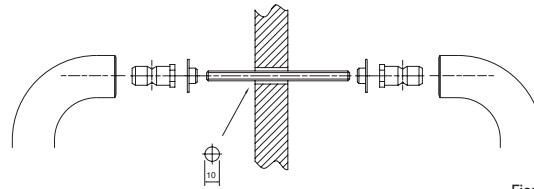

Fissaggio unificato doppio regolabile per porte in vetro
 Double fixing adjustable for glass ones available for all diameters
 Verstellbares Montageset paarweise für Ganzglastüren für alle stossgriffdurchmesser geeignet
 Fixation double réglable pour toutes portes en verre variable pour tous less diamètres

F1012	varie	alluminio-inox-serie 8000	1	0,2
Categoria commerciale: 4B				

F1042

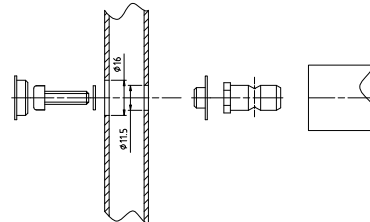

Fissaggio unificato singolo con tappo per profili tubolari
 Fixing with plug except for glass doors available for all diameters (through hole)
 Montageset zum Durchschrauben mit Blindrossette für alle stossgriffdurchmesser geeignet (durchgehendes Loch)
 Fixation avec bouchon pour portes bois ou métal variable pour tous less diamètres (trou passant)

F1042	varie	alluminio-inox-serie 8000	1	0,1
Categoria commerciale: 4B				

F110

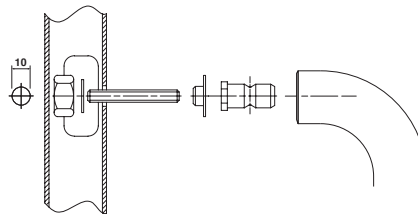

Fissaggio unificato singolo a fresatura per profili tubolari
 Single fixing by means of milling for tubular profiles
 Fixation simple à fraisage pour profils tubulaires
 Montageset einseitig zum Einfräsen für röhrenförmige Profile

F1100	varie	inox	1	0,1
Categoria commerciale: 4B				

F1111

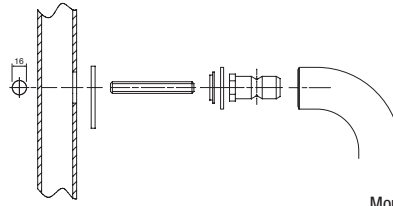

Fissaggio singolo ad aggancio rapido per profili tubolari
Single fixing with fast hooking for tubular profiles
Fixation simple avec accrochage rapide pour profils tubulaires
Montageset einseitig mit schneller Kupplung für röhrenförmige Profile

F1116	30	nylon ø30-serie 2100 ø30-alluminio	1	0,9

Categoria commerciale: 4B

F1120

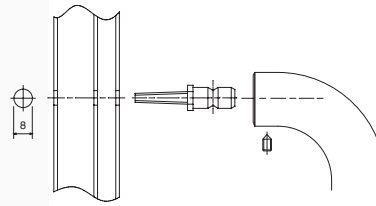

Fissaggio singolo per profili tripla camera (Serie 2100 Inox)
Single fixing for profiles with triple chamber (Serie 2100 Inox)
Einzelbefestigung für 3-kammerprofile (Serie 2100 Inox)
Fixation simple pour profils à trois chambres (Serie 2100 Inox)

F1120	30	serie 2100 ø30-alluminio	1	0,1

Categoria commerciale: 4B

F1200

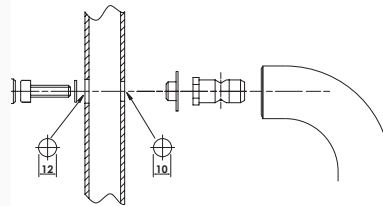

Fissaggio unificato singolo con tappo per profili tubolari (foro passante)
Single fixing with plug except for tubular profiles (through hole)
Fixation simple avec bouchon pour profils tubulaires (trou passant)
Montageset einseitig mit Stöpsel für röhrenförmigen Profilen (durchgehendes Loch)

F1200	varie	inox	1	0,2

Categoria commerciale: 4B

F1300

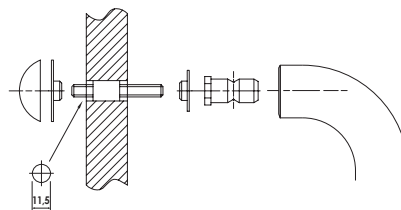

Fissaggio singolo per porte in vetro (foro passante)
Single fixing for glass doors (through hole)
Fixation simple pour en verre variable (trou passant)
Montageset einseitig für Ganzglastüren (durchgehendes Loch)

F1325S	25	inox	lucido	1	0,1
F1330S	30	inox	PVD	1	0,1
F1335S	35	inox	satinato	1	0,1

Categoria commerciale: 4B

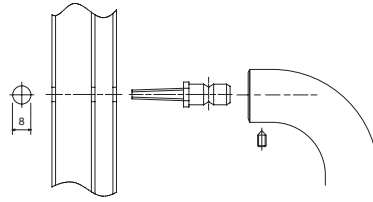

Fissaggio singolo per profili tripla camera
Single fixing for profiles with triple chamber
Einzelbefestigung für 3-kammerprofile
Fixation simple pour profils à trois chambres

F1400

F1400	varie	inox	1	0,1

Categoria commerciale: 4B

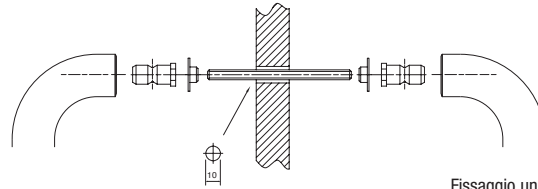

Fissaggio unificato doppio regolabile per profili tubolari
Adjustable double fixing for tubular profiles
Fixation double réglable pour profils tubulaires
Verstellbares Montageset paarweise für röhrenförmige Profile

F2000

F2000	varie	inox	1	0,1

Categoria commerciale: 4B

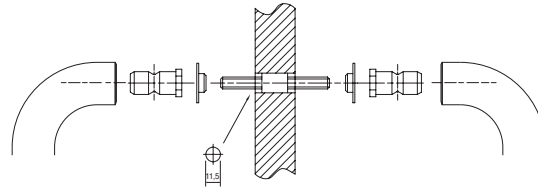

Fissaggio unificato doppio regolabile per porte in vetro
Adjustable double fixing for glass doors
Fixation double réglable pour portes en verre
Verstellbares Montageset paarweise für Ganzglastüren

F2001

F2001	varie	inox	1	0,1

Categoria commerciale: 4B

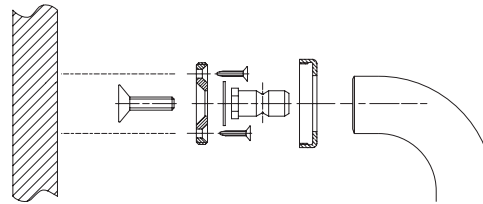

Fissaggio singolo con placca metallica per profili tubolari
Fixing with metal plate except for glass doors
Montageset zum Aufschrauben mit Rosette (nicht fuer Ganzglastueren) Fixation
avec rosace métallique pour portes bois ou métal

F3000

F3025S	25	inox	lucido	1	0,3
F3030S	30	inox	PVD	1	0,3
F3035S	35	inox	satinato	1	0,3

Categoria commerciale: 4B

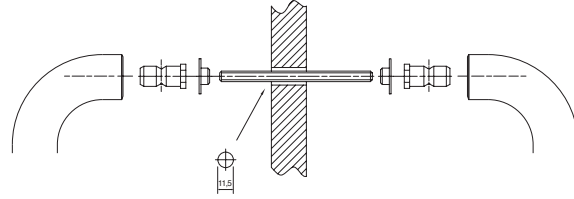

Fissaggio doppio regolabile per profili tubolari e porte in vetro
Adjustable double fixing for tubular profiles and glass doors
Fixation double réglable pour profils tubulaires et portes en verre
Verstellbares Montageset paarweise für röhrenförmige Profile und Ganzglastüren

F7016

F7016	varie	alluminio	1	0,2

Categoria commerciale: 4B

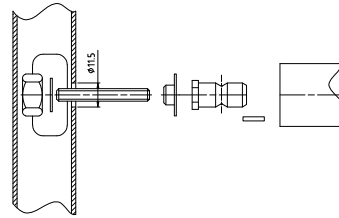

Fissaggio singolo a fresatura per profili tubolari
Single fixing by means of milling for tubular profiles
Fixation simple à fraisage pour profils tubulaires
Montageset einseitig zum Einfräsen für röhrenförmige Profile

F7036

F7036	30-35	alluminio, inox 2100 ø30	1	0,1

Categoria commerciale: 4B

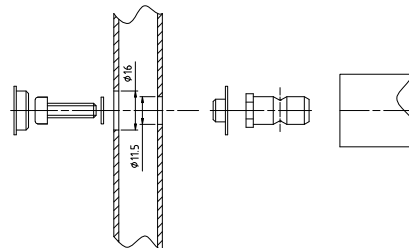

Fissaggio unificato singolo con tappo per profili tubolari - Serie 2100 Inox
Fixing with plug except for glass doors available for all diameters (through hole) - Serie 2100 Inox
Montageset zum Durchschrauben mit Blindrossette für alle stossgriffdurchmesser geeignet (durchgehendes Loch) - Serie 2100 Inox
Fixation avec bouchon pour portes bois ou métal variable pour tous less diamètres (trou passant) - Serie 2100 Inox

F7046

F7046	30-35	serie 2100 ø 30-alluminio	1	0,1

Categoria commerciale: 4B



Le immagini, i disegni tecnici e le relative specifiche appartengono a Fratelli Comunello SpA e sono protetti dalle leggi sul copyright. Ogni utilizzo non espressamente autorizzato sarà perseguito legalmente. Le specifiche dei prodotti sono soggette a cambiamenti senza preavviso. Possono essere richiesti su specifiche del cliente articoli con altre misure oppure a disegno. Foto immagini e disegni sono puramente indicativi. Fratelli Comunello SpA si riserva il diritto di apportare qualsiasi tipo di variazione, anche senza preavviso, al fine di aggiornare e migliorare il catalogo in qualsiasi momento. Fratelli Comunello SpA non risponde per eventuali errori tipografici o descrizioni errate di prodotti e caratteristiche tecniche.

All images, technical drawings and specifications are the exclusive property of Fratelli Comunello SpA and are protected by International Copyright laws. Any unauthorised use will result in legal proceedings. Fratelli Comunello SpA reserves the right to alter technical specifications at any time without notice. Clients may request bespoke products of different sizes and/or based on customised designs. All photographs and other images shown are for informational purposes only. Fratelli Comunello SpA reserves the right to make any kind of alteration, at any time and without prior notice so as to update and improve the catalogue. Fratelli Comunello SpA is not liable for any errors or other mistakes in the technical descriptions and technical characteristics of the products shown.

FRATELLI COMUNELLO S.P.A.

Via Cassola, 64 - C.P. 79

36027 Rosà, Vicenza, Italy

Tel. +39 0424 585111 Fax +39 0424 533417

info@comunello.it www.comunello.com







FRATELLI COMUNELLO S.P.A.

Part of the Comunello Group Srl

Via Cassola, 64 - C.P. 79 - 36027 Rosà, Vicenza, Italy

Tel. +39 0424 585111 Fax +39 0424 533417

info@comunello.it www.comunello.com