

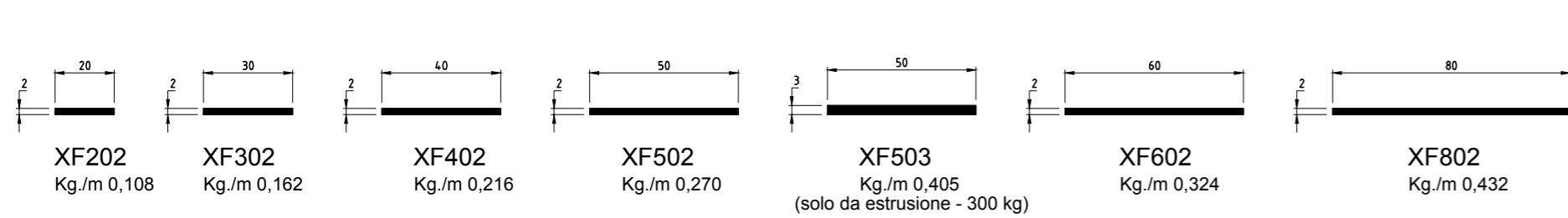

Tabellone 1-1

PIATTI



PROFILI "U"

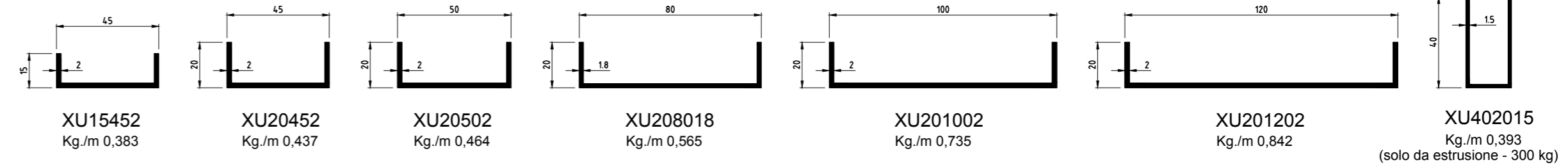

ANGOLARI

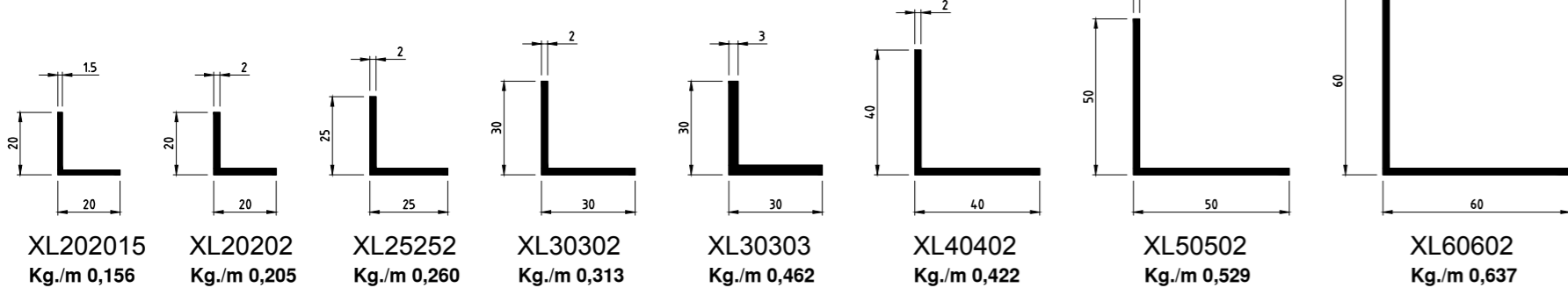

VARI

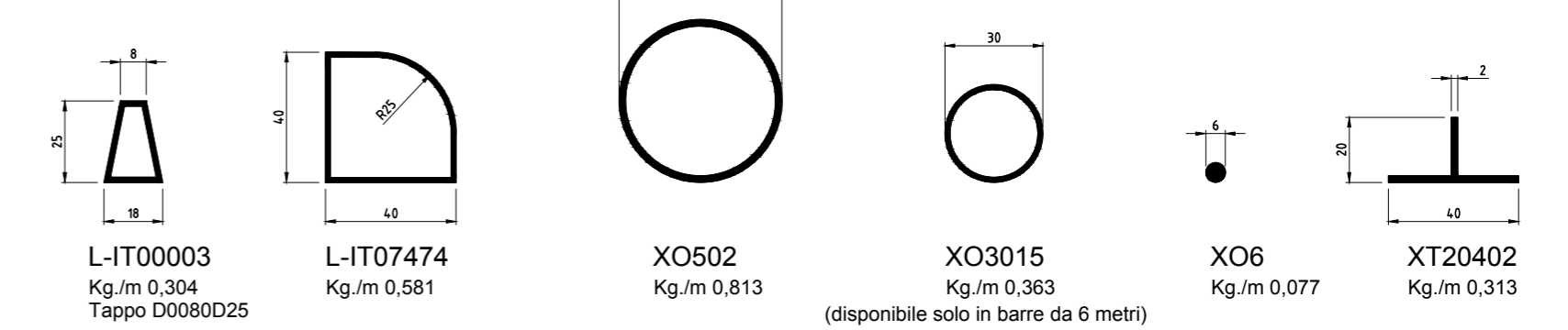

PROFILI "L"

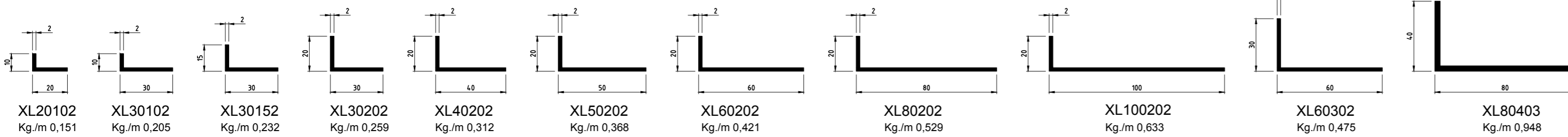

TUBI QUADRI

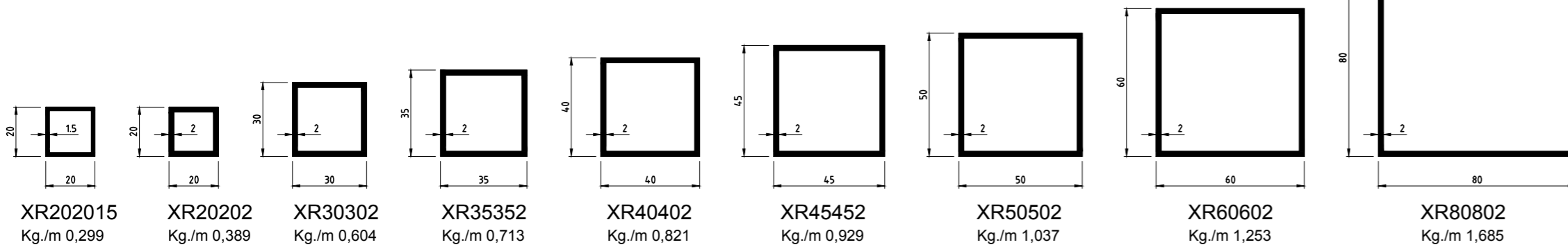

LA MISURA DELLE VERGHE E' DI 6.500 SALVO DIVERSA INDICAZIONE RIPORTATA A TABELLONE SOTTO IL CODICE PROFILO.

TUBI RETTANGOLO

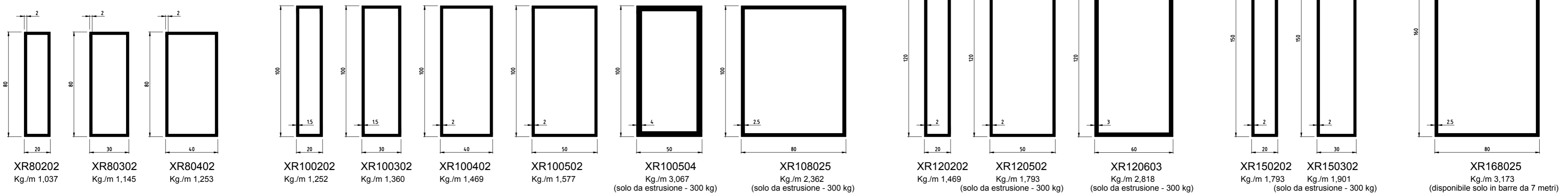
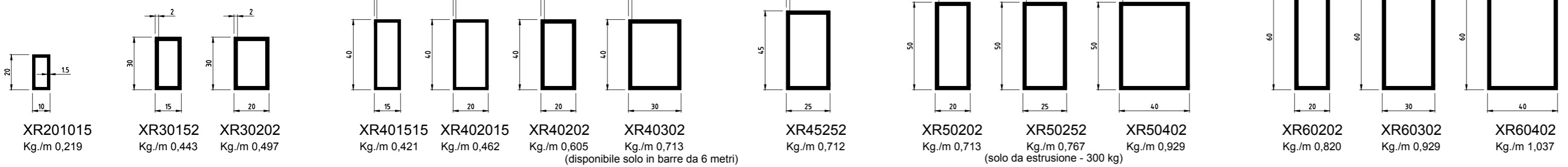

Data: GENNAIO 2017

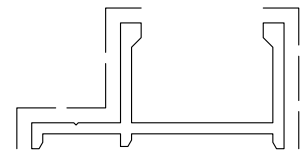

D0008713
sup.vista mm. 52
Kg./m 0.286

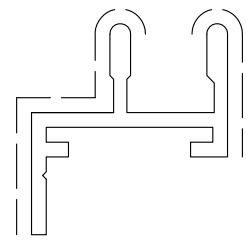

D0007592
sup.vista mm. 53
Kg./m 0.427

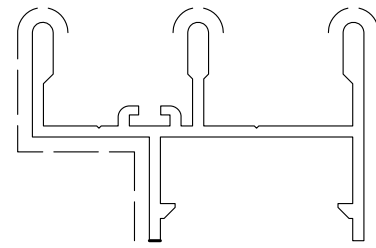

D0009179
sup.vista mm. 85
Kg./m 0.581

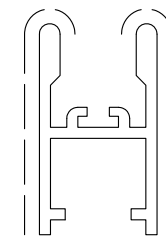

D0008712
sup.vista mm. 63
Kg./m 0.375

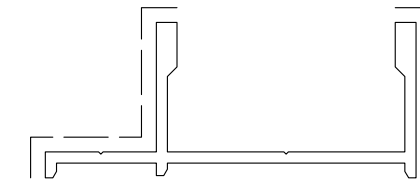

D3290163
sup.vista mm. 63
Kg./m 0.413

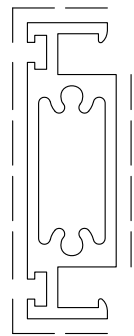

D3290162
sup.vista mm. 82
Kg./m 0.537

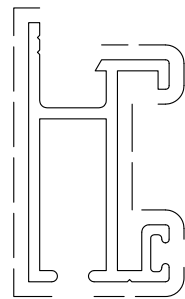

D0009182
sup.vista mm. 93
Kg./m 0.421

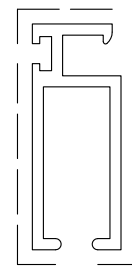

D3290161
sup.vista mm. 70
Kg./m 0.325

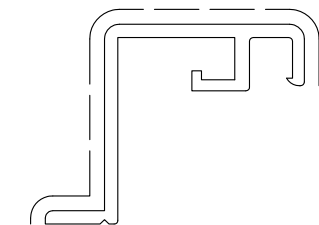

D3290097
sup.vista mm.68.5
Kg./m 0.381

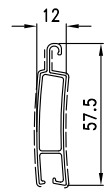

D0016033
sup.vista mm. 117
Kg./m 0.367
TAPPO D0031D23

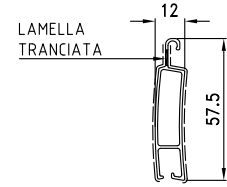

D0031D80
sup.vista mm. 117
Kg./m 0.367
TAPPO D0031D23

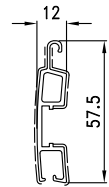

D0016055
sup.vista mm. 109
Kg./m 0.466

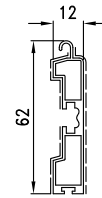

D0016034
sup.vista mm. 125
Kg./m 0.518
CATENACCIO D0031D13

D4210201
SPAZZOLINO 5x5

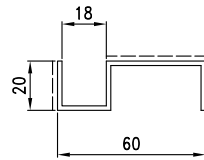

D3290147
sup.vista mm. 60
Kg./m 0.557

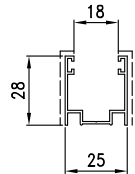

D3290155
sup.vista mm. 63.2
Kg./m 0.278

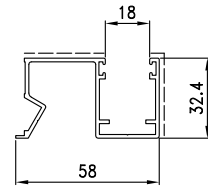

D3290157
sup.vista mm. 71
Kg./m 0.713
TAPPO D4240048

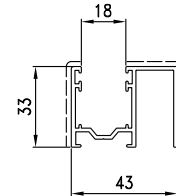

D3290159
sup.vista mm. 93
Kg./m 0.672
TAPPO D4240117

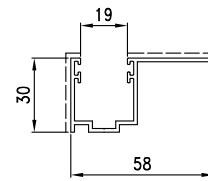

D3290111
sup.vista mm. 98
Kg./m 0.653

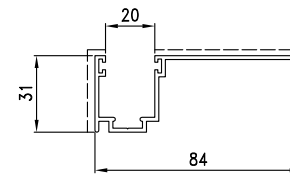

D3290160
sup.vista mm. 134.8
Kg./m 0.815

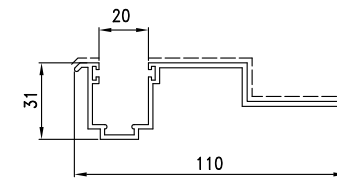

D3290150
sup.vista mm. 122.8
Kg./m 0.993



D0015125
sup.vista mm. 46
Kg./m 0.594

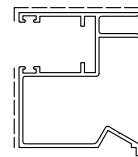

D0015127
sup.vista mm. 86
Kg./m 0.907
TAPPO D4240048

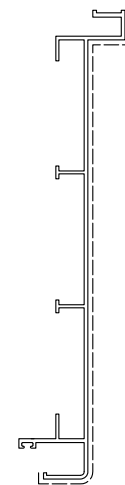

D3290066
sup.vista mm. 224
Kg./m 1.291
TAPPO D6240015

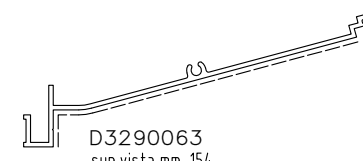

D3290063
sup.vista mm. 154
Kg./m 0.942
TAPPO D0080D04

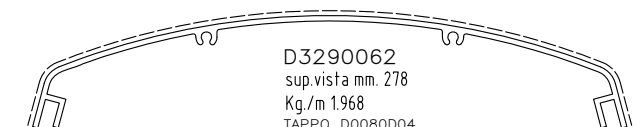

D3290062
sup.vista mm. 278
Kg./m 1.968
TAPPO D0080D04

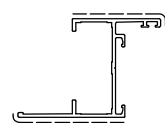

D3210223
sup.vista mm. 84
Kg./m 0.513

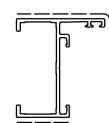

D3210225
sup.vista mm. 60
Kg./m 0.424

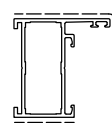

D3210226
sup.vista mm. 67
Kg./m 0.576

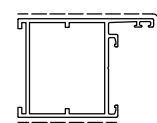

D3210227
sup.vista mm. 100
Kg./m 0.764

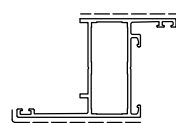

D3210230
sup.vista mm. 96
Kg./m 0.684

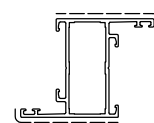

D3210231
sup.vista mm. 86
Kg./m 0.662



D3210235
sup.vista mm. 119
Kg./m 0.894



D3210236
sup.vista mm. 120
Kg./m 0.837

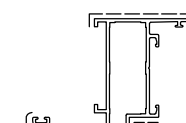

D3210238
sup.vista mm. 104
Kg./m 0.805

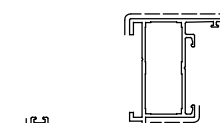

D3210239
sup.vista mm. 138
Kg./m 0.902

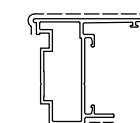

D3210242
sup.vista mm. 74
Kg./m 0.662
TAPPO D0040D08

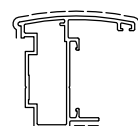

D3210243
sup.vista mm. 73
Kg./m 0.680
TAPPO D0040D18

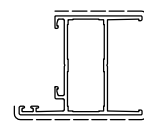

D3220055
sup.vista mm. 92
Kg./m 0.637

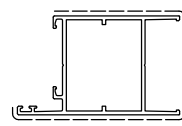

D3220056
sup.vista mm. 124
Kg./m 0.823

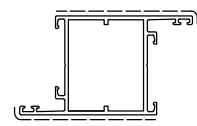

D3210248
sup.vista mm. 118
Kg./m 0.848

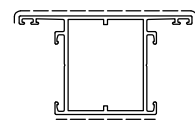

D3210247
sup.vista mm. 118
Kg./m 0.848

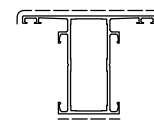

D3210249
sup.vista mm. 86
Kg./m 0.662

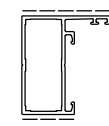

D3210246
sup.vista mm. 60
Kg./m 0.529

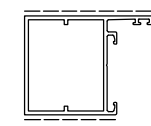

D3210228
sup.vista mm. 93
Kg./m 0.718

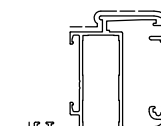

D3210257
sup.vista mm. 120
Kg./m 0.896

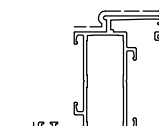

D3210261
sup.vista mm. 99
Kg./m 0.767

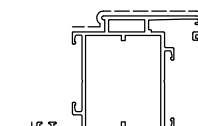

D3210262
sup.vista mm. 131
Kg./m 1.034

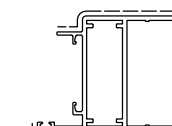

D3220064
sup.vista mm. 116
Kg./m 0.996

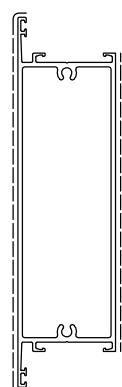

D3220058
sup.vista mm. 278
Kg./m 1.833

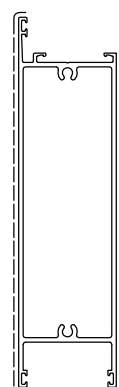

D3220057
sup.vista mm. 290
Kg./m 1.898

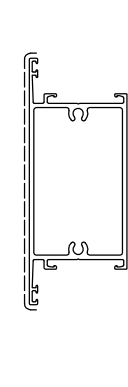

D3210269
sup.vista mm. 178
Kg./m 1.285

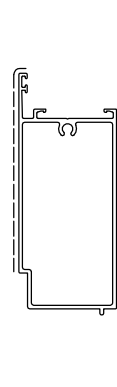

D3210270
sup.vista mm. 165
Kg./m 1.118

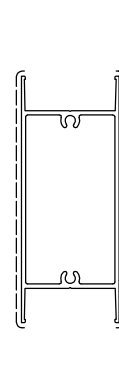

D3220061
sup.vista mm. 207
Kg./m 1.310

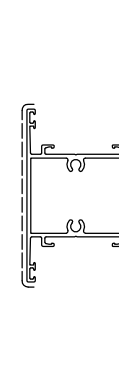

D3210271
sup.vista mm. 118
Kg./m 0.936

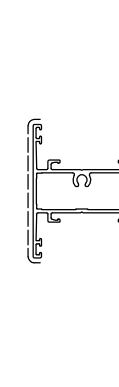

D3210273
sup.vista mm. 86
Kg./m 0.712

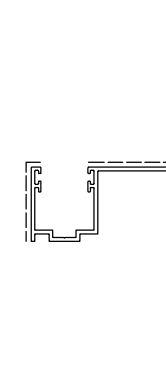

D3290111
sup.vista mm. 95
Kg./m 0.653



D3091045
sup. in vista mm. 34
kg/m. 0.210
TAPPO D4040029 **SX**
TAPPO D4040030 **DX**

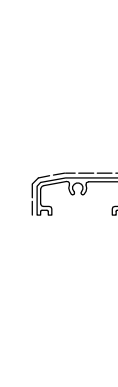

D3220060
sup.vista mm. 64
Kg./m 0.351

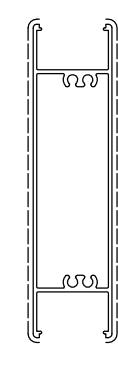

D3210276
sup.vista mm. 262
Kg./m 1.499

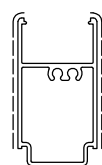

D3210274
sup.vista mm. 110
Kg./m 0.840

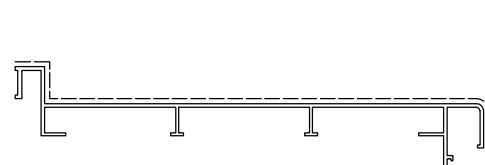

D3290066
sup.vista mm. 224
Kg./m 1.291
TAPPO D6240015

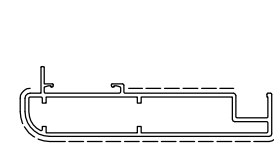

D3290112
sup.vista mm. 162
Kg./m 1.064

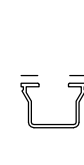

D3210174
sup.vista mm. 15
Kg./m 0.224

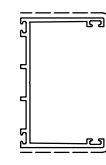

D3210056
sup.vista mm. 74
Kg./m 0.559



D3290002
sup.vista mm. 30
Kg./m 0.122

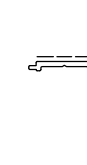

D3210279
sup.vista mm. 23
Kg./m 0.165

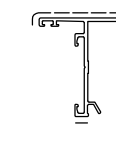

D3220062
sup.vista mm. 47
Kg./m 0.383

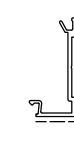

D3220063
sup.vista mm. 62
Kg./m 0.310

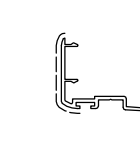

D0026261
sup.vista mm. 35
Kg./m 0.305

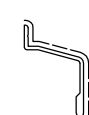

D0019624
sup.vista mm. 39
Kg./m 0.254

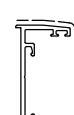

D3210277
sup.vista mm. 31
Kg./m 0.338



D0019622
sup.vista mm. 15
Kg./m 0.181



D0019625
sup.vista mm. 53
Kg./m 0.235



D0026260
sup.vista mm. 7.5
Kg./m 0.149

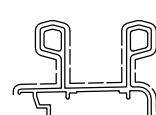

D0026263
sup.vista mm. 204
Kg./m 1.056

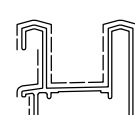

D0019629
sup.vista mm. 182
Kg./m 0.913

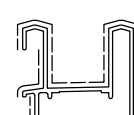

D0019630
sup.vista mm. 205
Kg./m 1.007

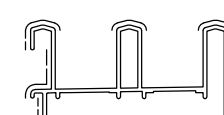

D0023355
sup.vista mm. 52
Kg./m 1.466

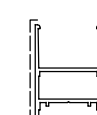

D0023313
sup.vista mm. 138
Kg./m 0.799

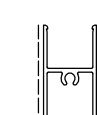

D0023334
sup.vista mm. 130
Kg./m 0.776

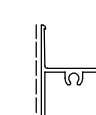

D0026169
sup.vista mm. 136
Kg./m 0.821



D0026262
sup.vista mm. 142
Kg./m 0.821

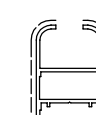

D0023335
sup.vista mm. 75
Kg./m 0.845

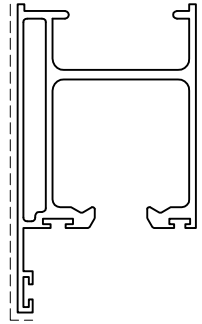

D3250003
kg/m 1.566
sup. in vista mm 146

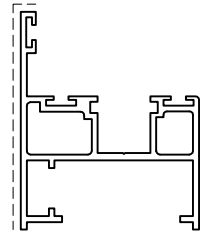

D3250004
kg/m 1.024
sup. in vista mm 98

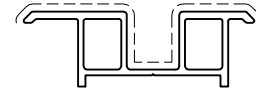

D3250005
kg/m 0.673
sup. in vista mm 92

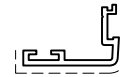

D3250031
kg/m 0.211
sup. in vista mm 36



D3290002
kg/m 0.122
sup. in vista mm 30



D3290001
kg/m 0.144
sup. in vista mm 14

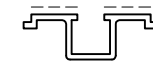

D3290002
kg/m 0.262
sup. in vista mm 25

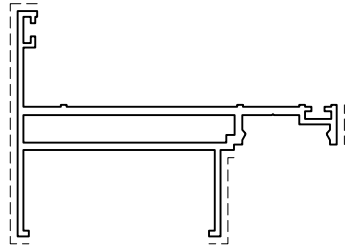

D3250002
kg/m 1.296
sup. in vista mm 108

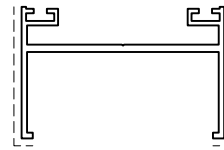

D3250001
kg/m 0.656
sup. in vista mm 76

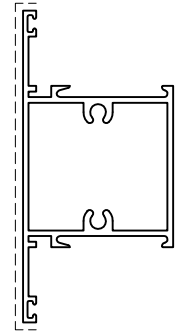

D3250021
kg/m 1.031
sup. in vista mm 133



D3280001
kg/m 0.347
sup. in vista mm 111



D3280002
kg/m 0.448
sup. in vista mm 141

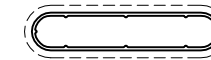

D0050013
kg/m 0.240
sup. in vista mm 111

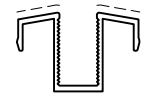

D3280007
kg/m 0.311
sup. in vista mm 21

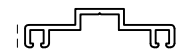

D0019632
kg/m 0.256
sup. in vista mm 12

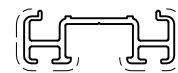

D3250007
kg/m 0.386
sup. in vista mm 44

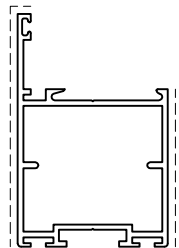

D3250011
kg/m 0.854
sup. in vista mm 108

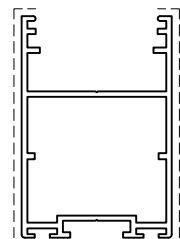

D3250012
kg/m 0.923
sup. in vista mm 126

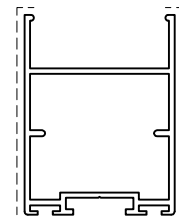



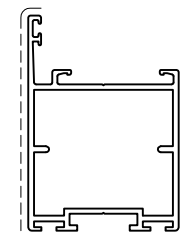



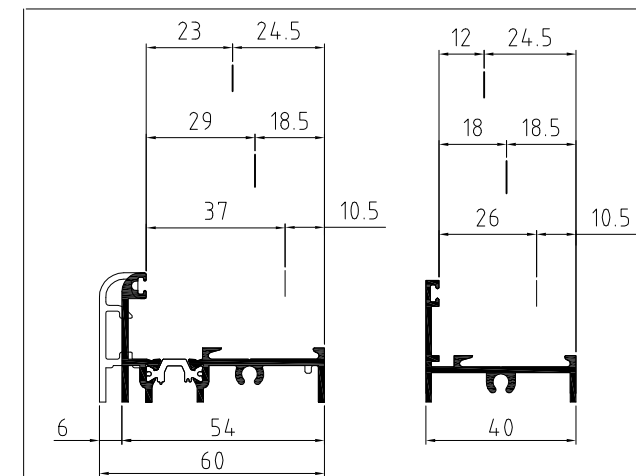





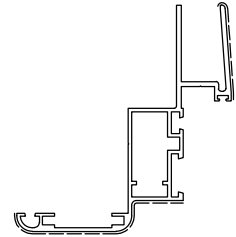
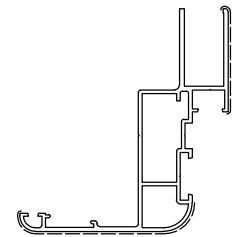
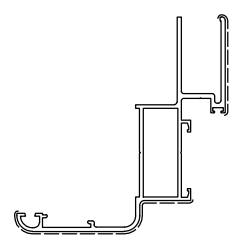
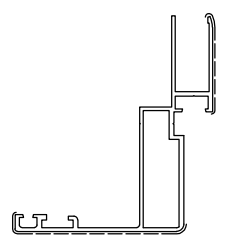
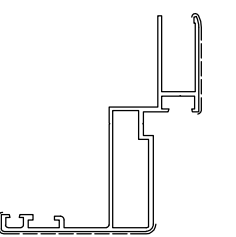
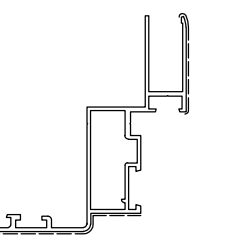
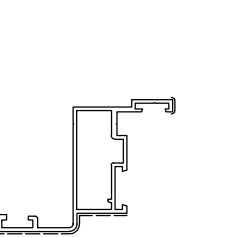
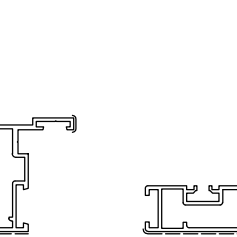
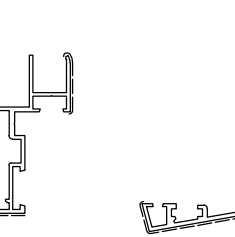
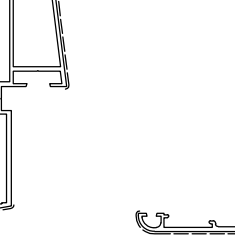
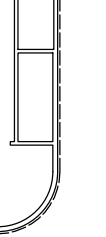
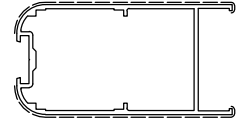
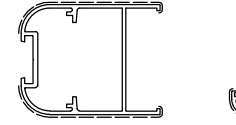
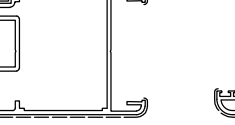
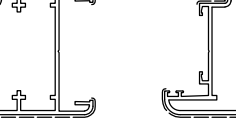
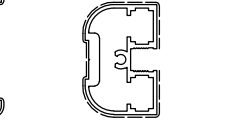
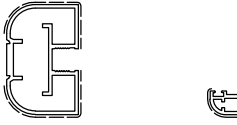
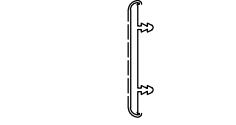
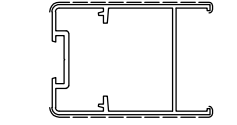
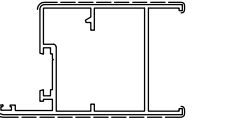
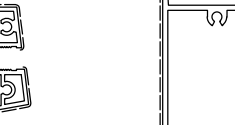



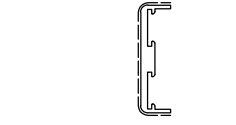
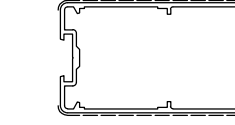
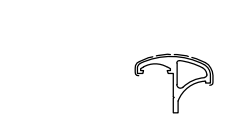
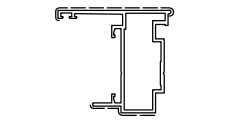

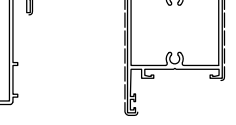
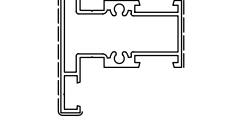
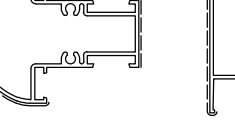
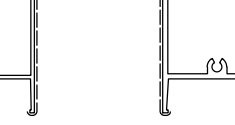

D0019650
kg/m 0.837
sup. in vista mm 106

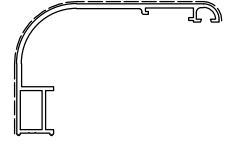
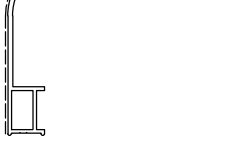

D0019656
kg/m 0.848
sup. in vista mm 105

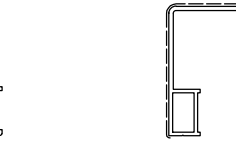
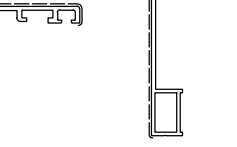
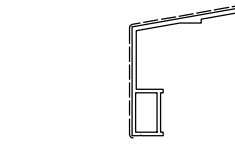
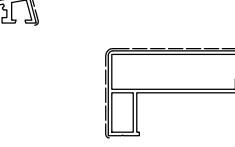
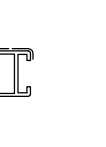
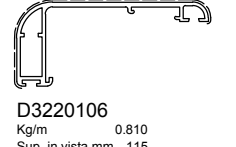
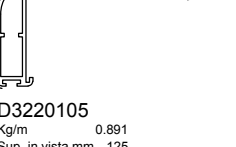
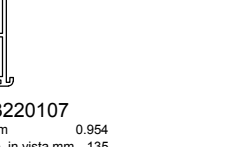
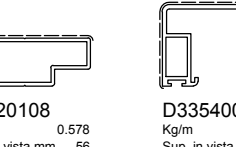

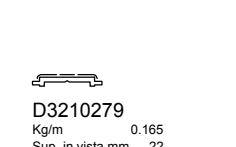
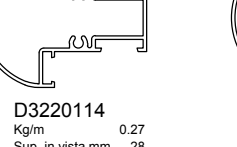
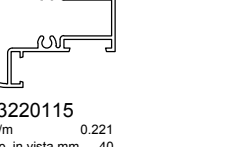
D3290190 kg/m 0.245 sup. in vista mm 44.5	D3290193 kg/m 0.240 sup. in vista mm 42
D3290189 kg/m 0.246 sup. in vista mm 39.5	D3290192 kg/m 0.235 sup. in vista mm 36
D3290188 kg/m 0.226 sup. in vista mm 30.5	D3290191 kg/m 0.216 sup. in vista mm 28
	

 D3220078 Kg/m 1.501 Sup. in vista mm 125	 D3220079 Kg/m 1.523 Sup. in vista mm 129	 D3220089 Kg/m 1.332 Sup. in vista mm 129	 D3354000 Kg/m 1.349 Sup. in vista mm 121	 D3354001 Kg/m 1.356 Sup. in vista mm 114	 D3354002 Kg/m 1.346 Sup. in vista mm 118	 D3354003 Kg/m 1.048 Sup. in vista mm 82	 D3354004 Kg/m 0.800 Sup. in vista mm 33	 D3354005 Kg/m 1.452 Sup. in vista mm 100	 D3354006 Kg/m 1.527 Sup. in vista mm 128	 D3220120 Kg/m 1.825 Sup. in vista mm 221		
 D3220082 Kg/m 1.333 Sup. in vista mm 199	 D3220084 Kg/m 0.960 Sup. in vista mm 135	 D3220092 Kg/m 1.457 Sup. in vista mm 172	 D3220093 Kg/m 1.248 Sup. in vista mm 140	 D3220094 Kg/m 0.994 Sup. in vista mm 108	 D3220116 Kg/m 1.007 Sup. in vista mm 110	 D3B20006 Kg/m 0.828 Sup. in vista mm 110	 D3220117 Kg/m 0.500 Sup. in vista mm 53	 D3354012 Kg/m 0.448 Sup. in vista mm 52	 D3354013 Kg/m 1.063 Sup. in vista mm 141	 D3354014 Kg/m 1.079 Sup. in vista mm 146	 D3354015 Kg/m 1.036 Sup. in vista mm 76	
 D3354016 Kg/m 0.624 Sup. in vista mm 87	 D3354017 Kg/m 0.765 Sup. in vista mm 66	 D3354018 Kg/m 0.528 Sup. in vista mm 67	 D3354019 Kg/m 1.372 Sup. in vista mm 189	 D3220081 Kg/m 0.390 Sup. in vista mm 41	 D3210242 Kg/m 0.662 Sup. in vista mm 81 Tappo D0040D08	 D3354022 Kg/m 0.421 Sup. in vista mm 113	 D3354020 Kg/m 0.912 Sup. in vista mm 79 Tappo D4076016	 D3210271 Kg/m 0.936 Sup. in vista mm 119	 D3354021 Kg/m 1.143 Sup. in vista mm 110	 D3220090 Kg/m 1.152 Sup. in vista mm 126	 D3220080 Kg/m 1.271 Sup. in vista mm 208 Tappo D0040D20	 D3220091 Kg/m 3.209 Sup. in vista mm 409
 D3220109 Kg/m 0.876 Sup. in vista mm 132	 D3220110 Kg/m 0.984 Sup. in vista mm 152	 D3220111 Kg/m 1.215 Sup. in vista mm 172	 D3220112 Kg/m 1.323 Sup. in vista mm 192	 D3220141 Kg/m 1.538 Sup. in vista mm 227	 D0034761 Kg/m 1.703 Sup. in vista mm 258	 D3220113 Kg/m 0.699 Sup. in vista mm 79	 D3354007 Kg/m 0.880 Sup. in vista mm 140	 D3354008 Kg/m 0.979 Sup. in vista mm 161	 D3354011 Kg/m 0.906 Sup. in vista mm 134	 D3354010 Kg/m 1.101 Sup. in vista mm 123		
 D3220106 Kg/m 0.810 Sup. in vista mm 115	 D3220105 Kg/m 0.891 Sup. in vista mm 125	 D3220107 Kg/m 0.954 Sup. in vista mm 135	 D3220108 Kg/m 0.578 Sup. in vista mm 56	 D3354009 Kg/m 0.817 Sup. in vista mm 120	 D3220118 Kg/m 0.273 Sup. in vista mm 0	 D3290001 Kg/m 0.144 Sup. in vista mm 14	 D3210279 Kg/m 0.165 Sup. in vista mm 22	 D3220114 Kg/m 0.27 Sup. in vista mm 28	 D3220115 Kg/m 0.221 Sup. in vista mm 40			

Non lavorabile con punzonatrice di sistema.

Non lavorabile con punzonatrice di sistema.
Cerniera D6210095.
Squadretta L-ITLM046710.

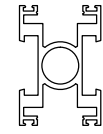

D0027470
Kg/m 1.322
Sup. in vista mm -

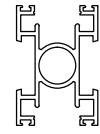

D0027490
Kg/m 1.019
Sup. in vista mm -



D0027474
Kg/m 0.617
Sup. in vista mm 61

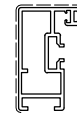

D3851001
Kg/m 0.657
Sup. in vista mm 70

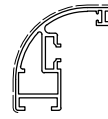

D0027488
Kg/m 0.641
Sup. in vista mm 72

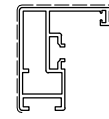

D3851000
Kg/m 0.716
Sup. in vista mm 84

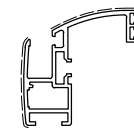

D0027487
Kg/m 0.796
Sup. in vista mm 74

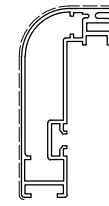

D0027483
Kg/m 1.121
Sup. in vista mm 110

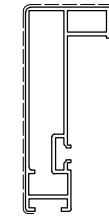

D3354010
Kg/m 1.101
Sup. in vista mm 123

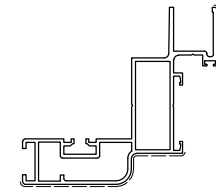

D0027484
Kg/m 1.385
Sup. in vista mm 103

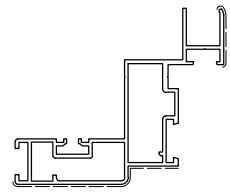

D3354005
Kg/m 1.452
Sup. in vista mm 100

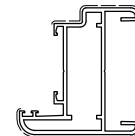

D3220094
Kg/m 0.994
Sup. in vista mm 108

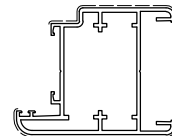

D3220093
Kg/m 1.248
Sup. in vista mm 140

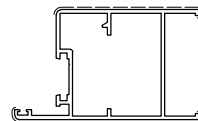

D3354014
Kg/m 1.079
Sup. in vista mm 146

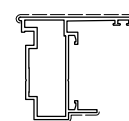

D3210242
Kg/m 0.662
Sup. in vista mm 81

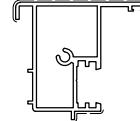

D3354020
Kg/m 0.912
Sup. in vista mm 79

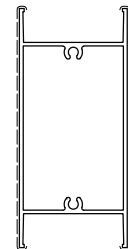

D3220080
Kg/m 1.271
Sup. in vista mm 208

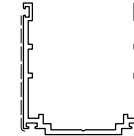

D0027479
Kg/m 0.948
Sup. in vista mm 95

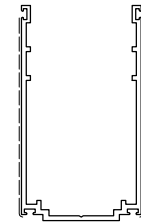

D0027478
Kg/m 1.326
Sup. in vista mm 165



D3260061
Kg/m 1.331
Sup. in vista mm 155

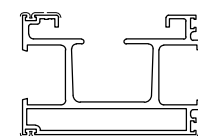

D0027462
Kg/m 1.952
Sup. in vista mm 103



D0027463
Kg/m 0.307
Sup. in vista mm 60

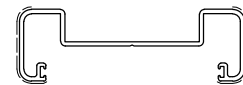

D0027482
Kg/m 0.976
Sup. in vista mm 83



D0027481
Kg/m 0.68
Sup. in vista mm 60



D0027475
Kg/m 0.839
Sup. in vista mm 45

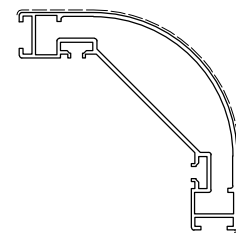

D0027480
Kg/m 1.59
Sup. in vista mm 157

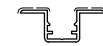

D0027477
Kg/m 0.208
Sup. in vista mm 25



D3210279
Kg/m 0.165
Sup. in vista mm 106



D3290001
Kg/m 0.144
Sup. in vista mm 14



D3220087
Kg/m 0.25
Sup. in vista mm 19



D3220085
Kg/m 0.25
Sup. in vista mm 32

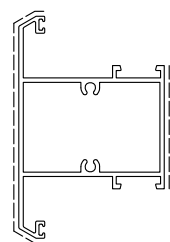

D0024462
sup.vista mm. 154
kg/m 1.496

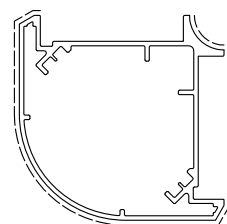

D0024499
sup.vista mm. 174
kg/m 2.031

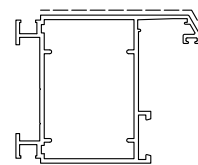

D0024461
sup.vista mm. 118
kg/m 1.372

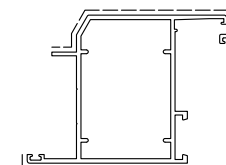

D0024463
sup.vista mm. 163
kg/m 1.336
TAPPO D0013D60

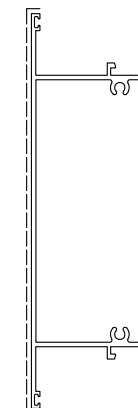

D3210086
sup.vista mm. 287
kg/m 2.036

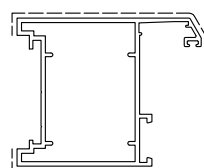

D0060105
sup.vista mm. 151
kg/m 1.415

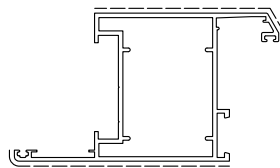

D0024470
sup.vista mm. 195
kg/m 1.587

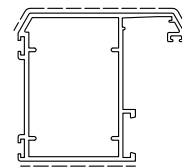

D0024473
sup.vista mm. 126
kg/m 1.266



D3290068
sup.vista mm. 36.5
kg/m 0.194

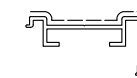

D0024472
sup.vista mm. 74
kg/m 0.429

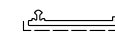

D3290067
sup.vista mm. 46.5
kg/m 0.251

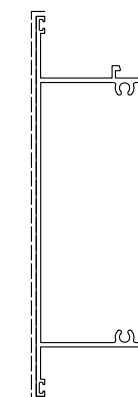

D3220020
sup.vista mm. 298
kg/m 2.014

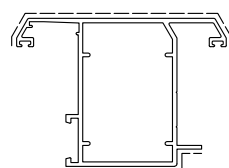

D0024464
sup.vista mm. 163
kg/m 1.401
TAPPO D0013D60

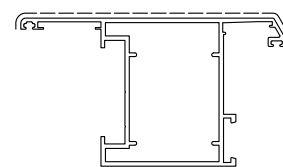

D0024471
sup.vista mm. 195
kg/m 1.587

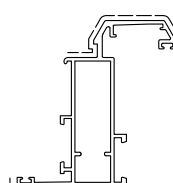

D0024479
sup.vista mm. 113
kg/m 1.042

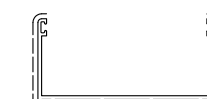

D0024478
sup.vista mm. 76
kg/m 0.626



D0024465
sup.vista mm. 14
kg/m 0.227

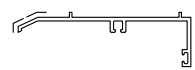

D0024474
sup.vista mm. 35
kg/m 0.424

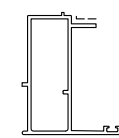

D0024466
sup.vista mm. 57
kg/m 0.640

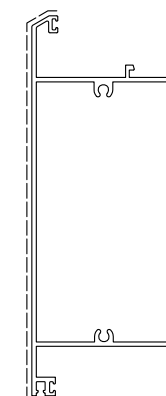

D0024469
sup.vista mm. 292
kg/m 2.238

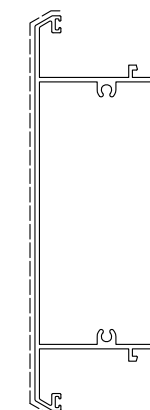

D0024468
sup.vista mm. 294
kg/m 2.218

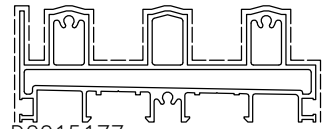

D0015177
sup.vista mm. 30
Kg/m 2.764

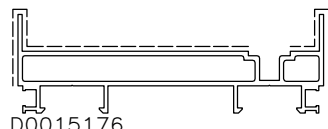

D0015176
sup.vista mm. 95
Kg/m 1.828

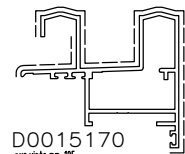

D0015170
sup.vista mm. 95
Kg/m 1.149

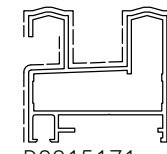

D0015171
sup.vista mm. 211
Kg/m 1.198

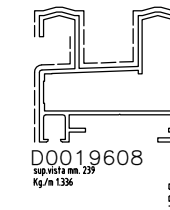

D0019608
sup.vista mm. 239
Kg/m 1.336

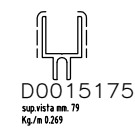

D0015175
sup.vista mm. 79
Kg/m 0.269

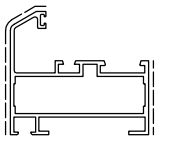

D3210071
sup.vista mm. 93
Kg/m 0.964

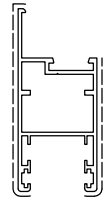

D0015190
sup.vista mm. 140
Kg/m 0.937

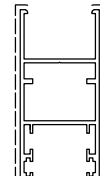

D0015188
sup.vista mm. 154
Kg/m 0.945

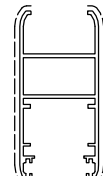

D0026255
sup.vista mm. 151
Kg/m 0.905

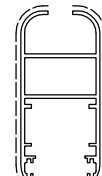

D0026265
sup.vista mm. 158
Kg/m 0.942

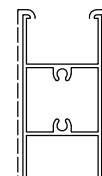

D0019620
sup.vista mm. 158
Kg/m 0.921

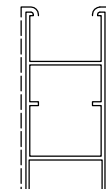

D0007515
sup.vista mm. 165
Kg/m 0.901



D0015182
sup.vista mm. 53
Kg/m 0.246
TAPPO D0011D07



D3290176
sup.vista mm. 14
Kg/m 0.156



D3290161
sup.vista mm. 70
Kg/m 0.325



D0015185
sup.vista mm. 99
Kg/m 0.292
TAPPO D4240274

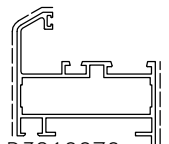

D3210070
sup.vista mm. 117
Kg/m 1.072



D0026291
sup.vista mm. 7
Kg/m 0.186



D3290001
sup.vista mm. 14
Kg/m 0.144



D3210311
sup.vista mm. 14
Kg/m 0.604

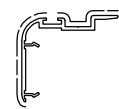

D0026264
sup.vista mm. 73
Kg/m 0.330

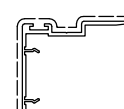

D0015191
sup.vista mm. 83
Kg/m 0.381

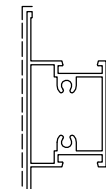

D0015186
sup.vista mm. 130
Kg/m 0.996



D0026267
sup.vista mm. 17
Kg/m 0.254



D0026244
sup.vista mm. 14
Kg/m 0.230

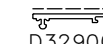

D3290068
sup.vista mm. 37
Kg/m 0.194

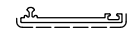

D3290067
sup.vista mm. 47
Kg/m 0.251

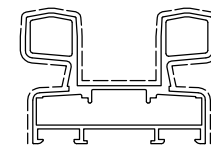

D3240075

kg/m. 1.856
Sup. in vista mm. 290

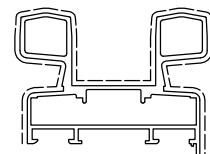

D3240059

kg/m. 1.976
Sup. in vista mm. 318

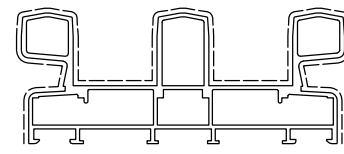

D3240076

kg/m. 2.931
Sup. in vista mm. 400



D3240056

kg/m. 0.384
Sup. in vista mm. --

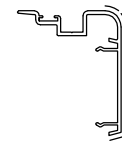

D3240064

kg/m. 0.497
Sup. in vista mm. 65

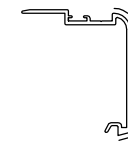

D3290174

kg/m. 0.448
Sup. in vista mm. 57

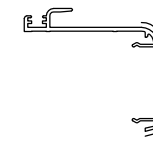

D3240061

kg/m. 0.527
Sup. in vista mm. 50

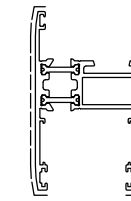

D1240022

kg/m. 1.256
Sup. in vista mm. 126

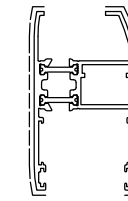

D1240023

kg/m. 1.329
Sup. in vista mm. 153

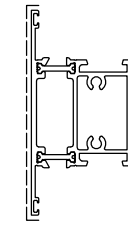

D1240026

kg/m. 1.356
Sup. in vista mm. 126

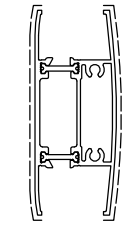

D1240027

kg/m. 1.411
Sup. in vista mm. 166

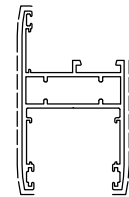

D3240069

kg/m. 1.072
Sup. in vista mm. 134

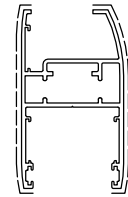

D3240070

kg/m. 1.180
Sup. in vista mm. 162

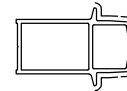

D3240065

kg/m. 0.643
Sup. in vista mm. 58



D3240055

kg/m. 0.273
Sup. in vista mm. 42



D3240054

kg/m. 0.200
Sup. in vista mm. 27

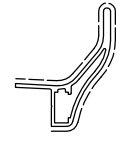

D3290172

kg/m. 0.524
Sup. in vista mm. 119

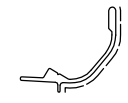

D3290170

kg/m. 0.338
Sup. in vista mm. 49



D3290161

kg/m. 0.325
Sup. in vista mm. 70

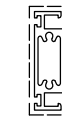

D3290162

kg/m. 0.527
Sup. in vista mm. 81



D3290169

kg/m. 0.355
Sup. in vista mm. 58



D0034127

kg/m. 0.451
Sup. in vista mm. --

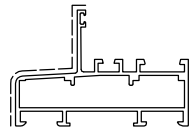

D3240073

kg/m. 1.123
Sup. in vista mm. 99



D3240009

kg/m. 0.251
Sup. in vista mm. 16



D3210314

kg/m. 0.235
Sup. in vista mm. 30.5



D3240057

kg/m. 0.278
Sup. in vista mm. --



D3290002

kg/m. 0.122
Sup. in vista mm. 30

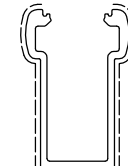

D3290167

kg/m. 1.450
Sup. in vista mm. 146

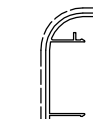

D3290125

kg/m. 0.302
Sup. in vista mm. 59

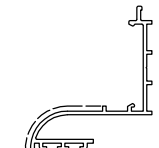

D3290126

kg/m. 0.626
Sup. in vista mm. 39

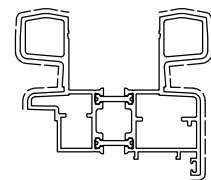

D1240030

kg/m. 1.964
Sup. in vista mm. 199

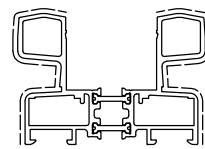

D1240019

kg/m. 1.980
Sup. in vista mm. 196

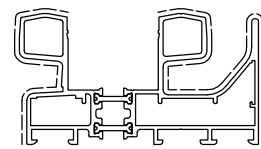

D1240017

kg/m. 2.450
Sup. in vista mm. 273

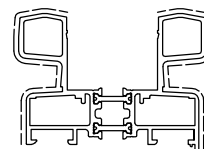

D1240024

kg/m. 2.102
Sup. in vista mm. 228

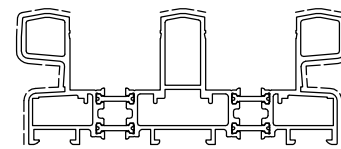

D1240018

kg/m. 3.223
Sup. in vista mm. 214

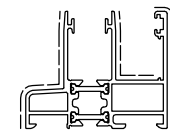

D1240014

kg/m. 1.330
Sup. in vista mm. 160

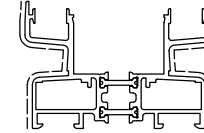

D1240015

kg/m. 1.842
Sup. in vista mm. 160

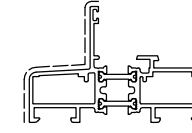





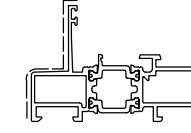





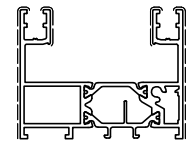
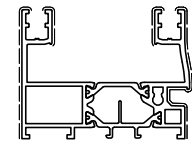
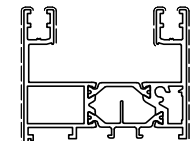
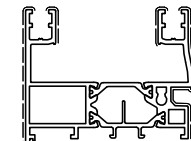
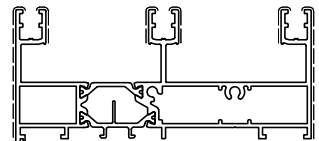
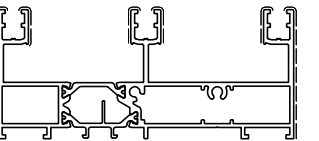
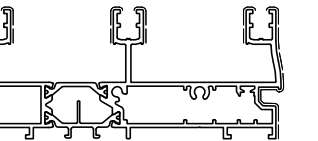
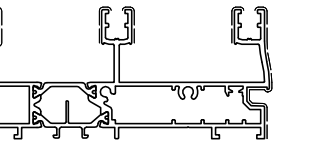
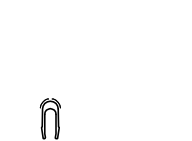
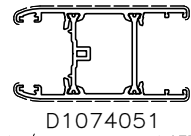
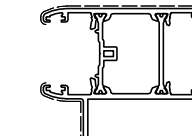
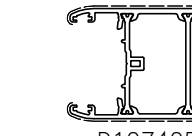
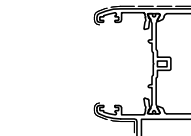
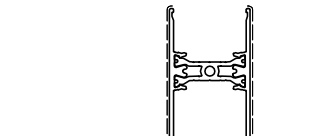
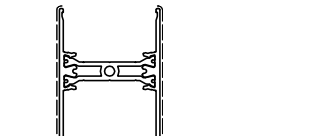



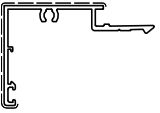
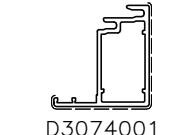
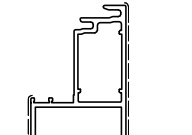
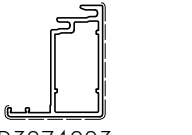
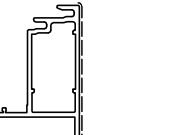

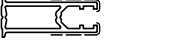

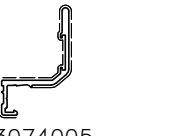

D1240020

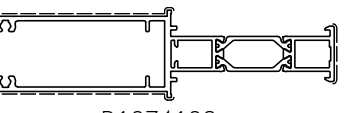
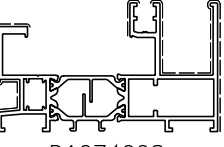
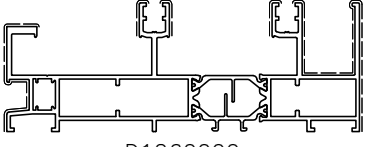
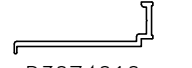
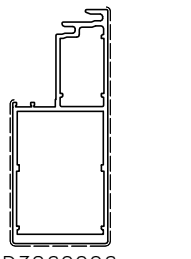
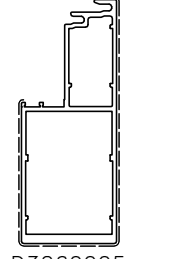
kg/m. 1.324
Sup. in vista mm. 99

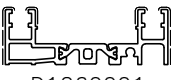
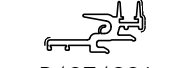
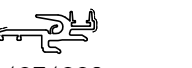

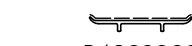
D1210286

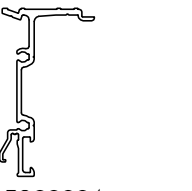
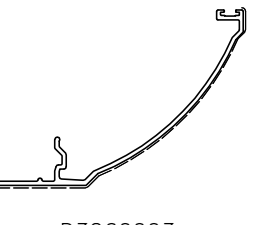
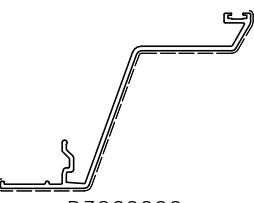
kg/m. 1.306
Sup. in vista mm. 92

 D1074001 kg/m. 1.520 sup. in vista mm. 140	 D1074002 kg/m. 1.528 sup. in vista mm. 157	 D1074003 kg/m. 1.649 sup. in vista mm. 167	 D1074004 kg/m. 1.662 sup. in vista mm. 184	 D1074005 kg/m. 2.447 sup. in vista mm. 199	 D1074006 kg/m. 2.314 sup. in vista mm. 172	 D1074007 kg/m. 2.524 sup. in vista mm. 302	 D1074000 kg/m. 2.391 sup. in vista mm. 276	 D3074028 kg/m. 0.106 sup. in vista mm. 9		
 D1074051 kg/m. 1.077 sup. in vista mm. 151	 D1074052 kg/m. 1.625 sup. in vista mm. 190 TAPPO D4074006	 D1074053 kg/m. 1.114 sup. in vista mm. 151	 D1074054 kg/m. 1.661 sup. in vista mm. 190 TAPPO D4074006	 D1074076 kg/m. 0.952 sup. in vista mm. 212	 D1074078 kg/m. 0.988 sup. in vista mm. 142	 D1074077 kg/m. x x 0.893 sup. in vista mm. 132	 D1074079 kg/m. 0.929 sup. in vista mm. 132	 D3074007 kg/m. 0.325 sup. in vista mm. 49	 D3074008 kg/m. 0.549 sup. in vista mm. 84	
 D3074001 kg/m. 0.659 sup. in vista mm. 82	 D3074002 kg/m. 1.304 sup. in vista mm. 152 TAPPO D4074007	 D3074003 kg/m. 0.695 sup. in vista mm. 86	 D3074004 kg/m. 1.341 sup. in vista mm. 154 TAPPO D4074007	 D3074030 kg/m. 0.188 sup. in vista mm. 38	 D3074029 kg/m. 0.432 sup. in vista mm. 42 TAPPO D4074011	 D3074026 kg/m. 0.306 sup. in vista mm. 90 TAPPO D4074008	 D3074005 kg/m. 0.361 sup. in vista mm. 108	 D3074027 kg/m. 0.1 sup. in vista mm. 20	 D3290161 kg/m. 0.325 sup. in vista mm. 68	 D3290162 kg/m. 0.537 sup. in vista mm. 82
 D1074101 kg/m. 0.883 sup. in vista mm. 51	 D1074102 kg/m. 1.964 sup. in vista mm. 206	 D1074008 kg/m. 1.770 sup. in vista mm. 225	 D1260000 kg/m. 2.556 sup. in vista mm. 257	 D3074010 kg/m. 0.401 sup. in vista mm. 0	 D3260006 kg/m. 1.538 sup. in vista mm. 188	 D3260005 kg/m. 1.574 sup. in vista mm. 192	 D3260002 kg/m. 0.795 sup. in vista mm. 119	 D1260001 kg/m. 0.886 sup. in vista mm. 73		
 D4074001 kg/m. 0.247 sup. in vista mm. 20	 D4074002 kg/m. 0.225 sup. in vista mm. 18	 D4074003 kg/m. 0.149 sup. in vista mm. 0.66	 D4074004 kg/m. 0.090 sup. in vista mm. 37	 D4074020 kg/m. 0.25 sup. in vista mm. 9	 D4260066 kg/m. 0.07 sup. in vista mm. 41	 D3260004 kg/m. 0.771 sup. in vista mm. 0	 D3260003 kg/m. 0.774 sup. in vista mm. 135	 D3260000 kg/m. 0.871 sup. in vista mm. 151	 D3260001 kg/m. 0.676 sup. in vista mm. 107	

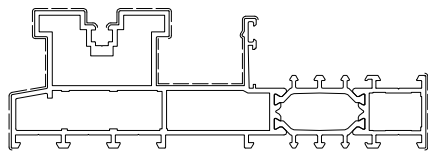

SC9K010
sup.vista mm. 000
Kg./m 3.225

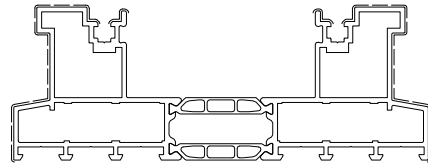

SC9K020
sup.vista mm. 000
Kg./m 3.527

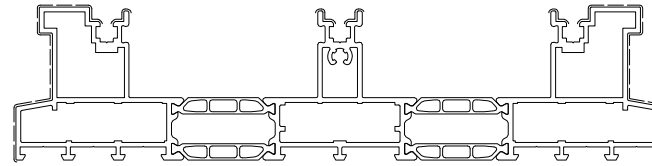

SC9K030
sup.vista mm. 000
Kg./m 5.192

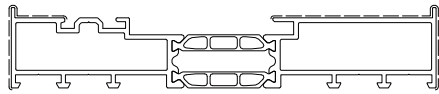

SC9K121
sup.vista mm. 000
Kg./m 2.373

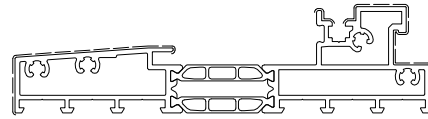

SC9K100
sup.vista mm. 000
Kg./m 2.954

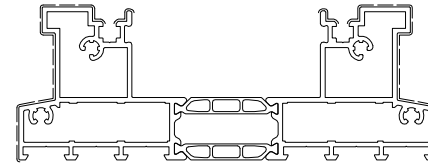

SC9K120
sup.vista mm. 000
Kg./m 3.681



D1110000
sup.vista mm. 183
Kg./m 2.405

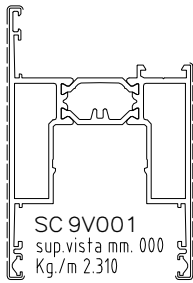

SC9V001
sup.vista mm. 000
Kg./m 2.310

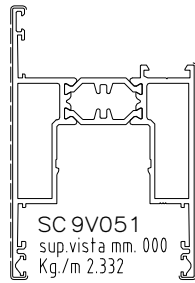

SC9V051
sup.vista mm. 000
Kg./m 2.332

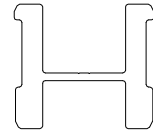

SC9C001
sup.vista mm. 000
Kg./m 2.621

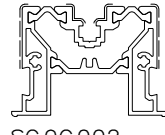

SC9C002
sup.vista mm. 000
Kg./m 1.645

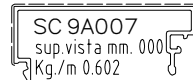

SC9A007
sup.vista mm. 000
Kg./m 0.602



SC9A004
sup.vista mm. 000
Kg./m 0.299



SC9A003
sup.vista mm. 000
Kg./m 0.156



SC9A009
sup.vista mm. 000
Kg./m 0.2

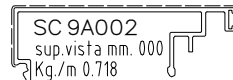

SC9A002
sup.vista mm. 000
Kg./m 0.718



S52A28
sup.vista mm. 000
Kg./m 0.059



SZ9C030
sup.vista mm. 000
Kg./m 0.130



SZ9A016
sup.vista mm. 000
Kg./m 0.233



SZ9C005
sup.vista mm. 000
Kg./m 0.315

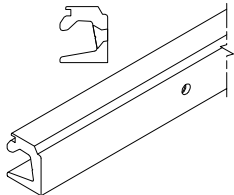

SCO2206
sup.vista mm. 000
Kg./m 0.000

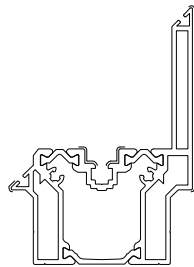

SC9C003
sup.vista mm. 000
Kg./m 2.416

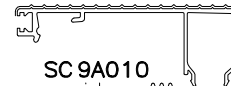

SC9A010
sup.vista mm. 000
Kg./m 0.733

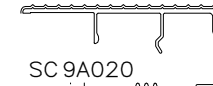

SC9A020
sup.vista mm. 000
Kg./m 0.605

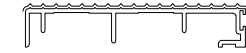

D3110000
sup.vista mm. 93
Kg./m 0.668



SC9A100
sup.vista mm. 000
Kg./m 0.505

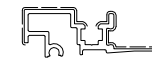

SC9A101
sup.vista mm. 000
Kg./m 0.528

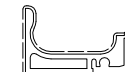

D3110001
sup.vista mm. 82
Kg./m 0.615



SCO1103

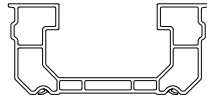

SKU2028

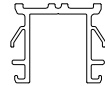

SKU2027



SKU2054



S215008



SKU2035

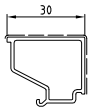

SGC 2330
sup.vista mm. 000
Kg./m 0.341

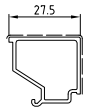

SGC 2327
sup.vista mm. 000
Kg./m 0.327

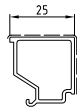

SGC 2325
sup.vista mm. 000
Kg./m 0.312

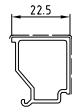

SGC 2322
sup.vista mm. 000
Kg./m 0.298



SGC 2320
sup.vista mm. 000
Kg./m 0.286



SGC 2317
sup.vista mm. 000
Kg./m 0.275



SGC 2315
sup.vista mm. 000
Kg./m 0.267



SGC 2312
sup.vista mm. 000
Kg./m 0.262



SGC 2310
sup.vista mm. 000
Kg./m 0.259

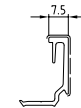

SGC 0307
sup.vista mm. 000
Kg./m 0.236

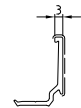

SGC 0303
sup.vista mm. 000
Kg./m 0.187



Domal Slide C160 Smarttir

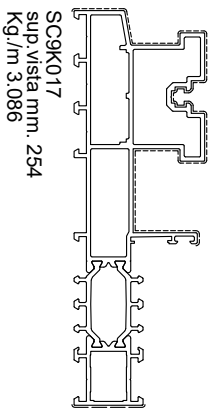

SC9K017
sup. vista mm. 254
Kg./m 3.086

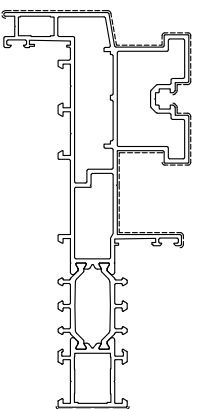

SC9K018
sup. vista mm. 273
Kg./m 3.376

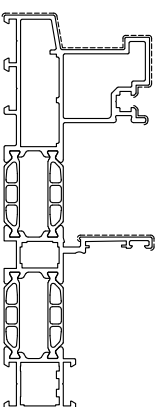

SC9K014
sup. vista mm. 180
Kg./m 3.184

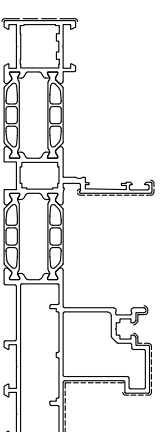

SC9K028
sup. vista mm. 255
Kg./m 3.476



SC9K013
sup. vista mm. 180
Kg./m 3.184

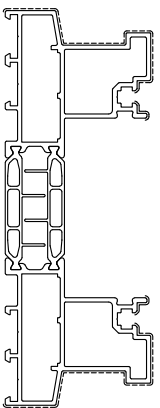

SC9K024
sup. vista mm. 230
Kg./m 3.351

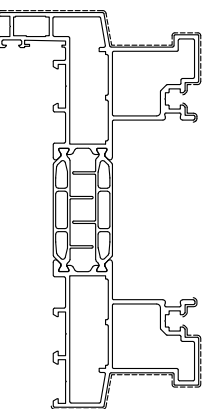

SC9K025
sup. vista mm. 248
Kg./m 3.611

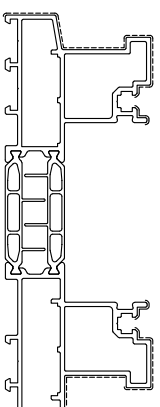

SC9K026
sup. vista mm. 312
Kg./m 3.643

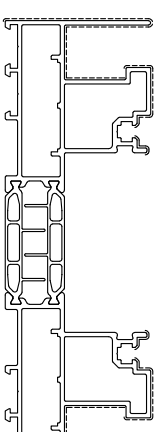

SC9K027
sup. vista mm. 383
Kg./m 3.936



SC9K019
sup. vista mm. 230
Kg./m 3.351

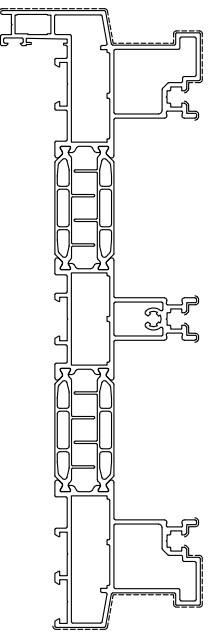

SC9K035
sup. vista mm. 274
Kg./m 5.330

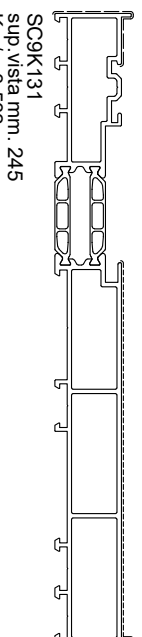

SC9K131
sup. vista mm. 245
Kg./m 3.532

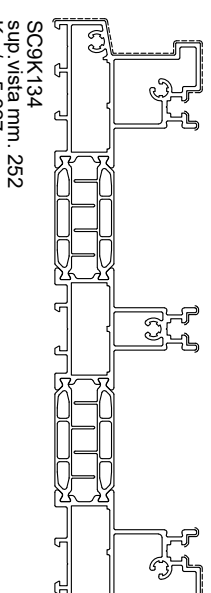

SC9K134
sup. vista mm. 252
Kg./m 5.327

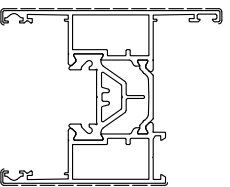

SC9V101
sup. vista mm. 169
Kg./m 2.052

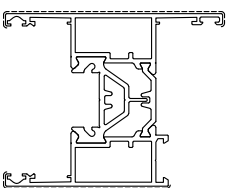

SC9V151
sup. vista mm. 169
Kg./m 2.097

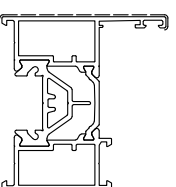

SC9V102
sup. vista mm. 116
Kg./m 1.807

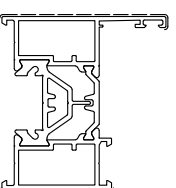

SC9V152
sup. vista mm. 116
Kg./m 1.829

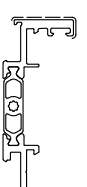

SC9V107
sup. vista mm. 46
Kg./m 0.963

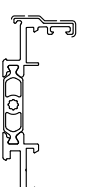

SC9V108
sup. vista mm. 44
Kg./m 0.894

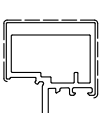

SC9V109
sup. vista mm. 116
Kg./m 1.807

Nuova soluzione labirinto centrale

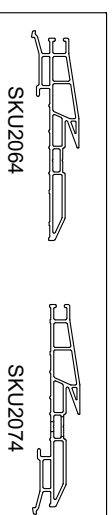

SKU2064

SKU2074



SKU2065

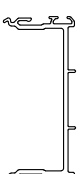

SKU2071

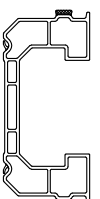

SKU2028

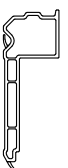

SKU2035

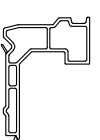

SKU2065



~~SKU2054~~

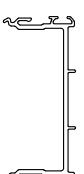

























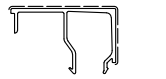
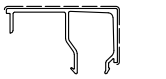
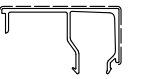
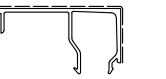











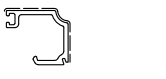
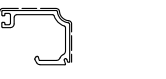
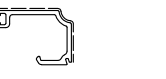
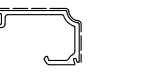
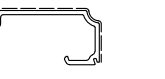









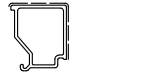
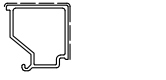
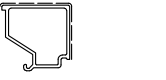
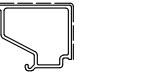
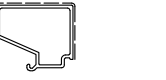
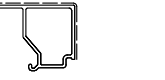
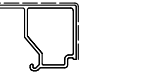
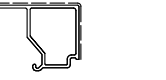
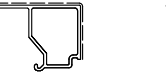
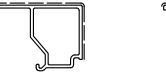
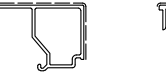
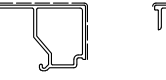
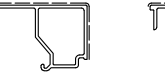
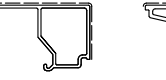
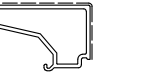
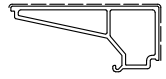
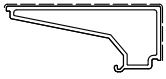





























SKU2071



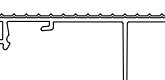

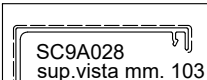
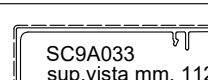
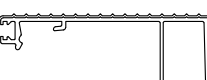
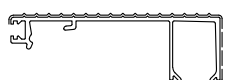
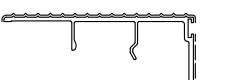
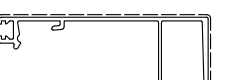

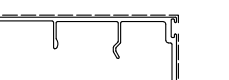
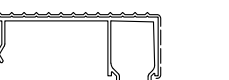
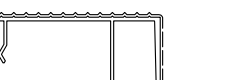



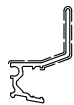



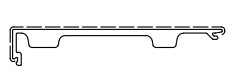
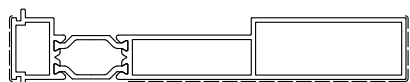
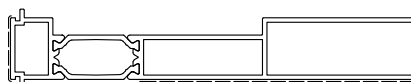
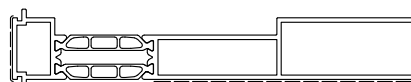



















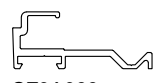
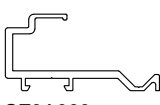
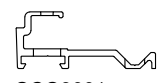
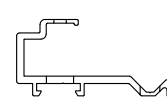

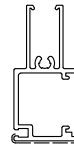
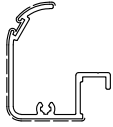
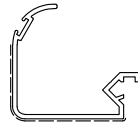
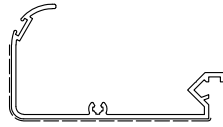
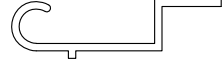

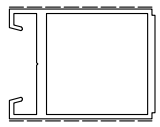
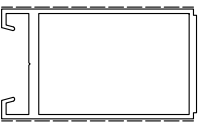

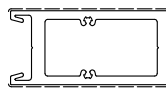

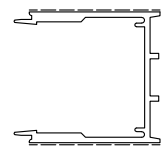
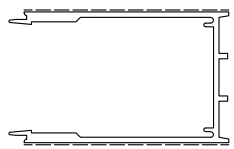



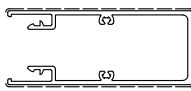
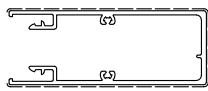

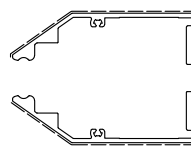
S215008

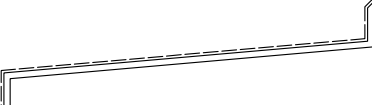
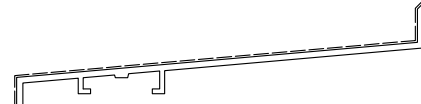
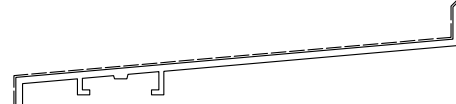
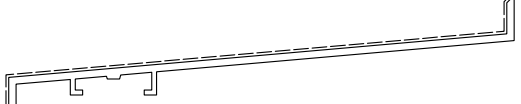

SRU9706
sup. vista mm. 36.7
Kg./m 0.234

 SGC0303 sup.vista mm. 25 Kg./m 0.188	 SGC0307 sup.vista mm. 30 Kg./m 0.236	 SGC0310 sup.vista mm. 32 Kg./m 0.256	 SGC0312 sup.vista mm. 35 Kg./m 0.263	 SGC0315 sup.vista mm. 37 Kg./m 0.268	 SGC0317 sup.vista mm. 40 Kg./m 0.276	 SGC0320 sup.vista mm. 42 Kg./m 0.313	 SGC0322 sup.vista mm. 45 Kg./m 0.321	 SGC0325 sup.vista mm. 47 Kg./m 0.327	 SGC0327 sup.vista mm. 50 Kg./m 0.335	 SGC0330 sup.vista mm. 52 Kg./m 0.350	 SGC0332 sup.vista mm. 55 Kg./m 0.358	 SGC0335 sup.vista mm. 57 Kg./m 0.366	 SGC0337 sup.vista mm. 60 Kg./m 0.374	 SGC0340 sup.vista mm. 62 Kg./m 0.382
 SGC0342 sup.vista mm. 66 Kg./m 0.405	 SGC0345 sup.vista mm. 67 Kg./m 0.416	 SGC0347 sup.vista mm. 70 Kg./m 0.426	 SGC0350 sup.vista mm. 72 Kg./m 0.436	 SGF5312 sup.vista mm. 79 Kg./m 0.232	 SGF5315 sup.vista mm. 32 Kg./m 0.244	 SGF5317 sup.vista mm. 34 Kg./m 0.255	 SGF5320 sup.vista mm. 37 Kg./m 0.266	 SGF5325 sup.vista mm. 42 Kg./m 0.289	 SGF5330 sup.vista mm. 47 Kg./m 0.312	 SGF5335 sup.vista mm. 52 Kg./m 0.335	 SGF5345 sup.vista mm. 62 Kg./m 0.381	 SGR5312 sup.vista mm. 31 Kg./m 0.238	 SGR5315 sup.vista mm. 34 Kg./m 0.250	 SGR5317 sup.vista mm. 36 Kg./m 0.262
 SGR5320 sup.vista mm. 39 Kg./m 0.273	 SGR5325 sup.vista mm. 44 Kg./m 0.296	 SGR5327 sup.vista mm. 46 Kg./m 0.308	 SGR5330 sup.vista mm. 49 Kg./m 0.319	 SGR5335 sup.vista mm. 54 Kg./m 0.342	 SGR5345 sup.vista mm. 64 Kg./m 0.388	 SGC2010 sup.vista mm. 24 Kg./m 0.210	 SGC2015 sup.vista mm. 29 Kg./m 0.215	 SGC2020 sup.vista mm. 34 Kg./m 0.234	 SGC2030 sup.vista mm. 44 Kg./m 0.294	 SGC2310 sup.vista mm. 32 Kg./m 0.259	 SGC2312 sup.vista mm. 35 Kg./m 0.262	 SGC2315 sup.vista mm. 37 Kg./m 0.267	 SGC2317 sup.vista mm. 37 Kg./m 0.267	 SGC2320 sup.vista mm. 42 Kg./m 0.286
 SGC2322 sup.vista mm. 45 Kg./m 0.298	 SGC2325 sup.vista mm. 47 Kg./m 0.312	 SGC2327 sup.vista mm. 50 Kg./m 0.327	 SGC2330 sup.vista mm. 52 Kg./m 0.341	 SGC2332 sup.vista mm. 55 Kg./m 0.357	 SGC2335 sup.vista mm. 57 Kg./m 0.367	 SGC2337 sup.vista mm. 60 Kg./m 0.375	 SGC2340 sup.vista mm. 62 Kg./m 0.383	 SGC2342 sup.vista mm. 65 Kg./m 0.391	 SGC2345 sup.vista mm. 67,1 Kg./m 0.39	 SGC2347 sup.vista mm. 69,6 Kg./m 0.398	 SGC2350 sup.vista mm. 72,1 Kg./m 0.403	 SGC2352 sup.vista mm. 74,5 Kg./m 0.410	 SGC2355 sup.vista mm. 77,1 Kg./m 0.418	 SGC2357 sup.vista mm. 79,6 Kg./m 0.615
 SGC2360 sup.vista mm. 82,1 Kg./m 0.668	 SGC2362 sup.vista mm. 84,6 Kg./m 0.655	 SGF2317 sup.vista mm. 36 Kg./m 0.262	 SGF2320 sup.vista mm. 38 Kg./m 0.272	 SGR2317 sup.vista mm. 37 Kg./m 0.267	 SGR2320 sup.vista mm. 40 Kg./m 0.278	 SGR2327 sup.vista mm. 47 Kg./m 0.321	 SGR2330 sup.vista mm. 50 Kg./m 0.336	 SGC2703 sup.vista mm. 33 Kg./m 0.253	 SGC2707 sup.vista mm. 38 Kg./m 0.301	 SGC2710 sup.vista mm. 42 Kg./m 0.312	 SGC2712 sup.vista mm. 43 Kg./m 0.314	 SGC2715 sup.vista mm. 45 Kg./m 0.319	 SGC2717 sup.vista mm. 48 Kg./m 0.327	 SGC2720 sup.vista mm. 50 Kg./m 0.337
 SGC2722 sup.vista mm. 53 Kg./m 0.350	 SGC2725 sup.vista mm. 55 Kg./m 0.364	 SGC2727 sup.vista mm. 58 Kg./m 0.379	 SGC2730 sup.vista mm. 60 Kg./m 0.394	 SGC2732 sup.vista mm. 63 Kg./m 0.409	 SGC2735 sup.vista mm. 65 Kg./m 0.425	 SGC2737 sup.vista mm. 68 Kg./m 0.441	 SGC0003 sup.vista mm. 17 Kg./m 0.152	 SGC0007 sup.vista mm. 22 Kg./m 0.199	 SGC0010 sup.vista mm. 24 Kg./m 0.212	 SGC0012 sup.vista mm. 27 Kg./m 0.202	 SGC0015 sup.vista mm. 29 Kg./m 0.208	 SGC0017 sup.vista mm. 32 Kg./m 0.214	 SGC0020 sup.vista mm. 34 Kg./m 0.225	 SGC0022 sup.vista mm. 37 Kg./m 0.233
 SGC0025 sup.vista mm. 39 Kg./m 0.258	 SGC0027 sup.vista mm. 42 Kg./m 0.263	 SGC0030 sup.vista mm. 44 Kg./m 0.278	 SGC0032 sup.vista mm. 47 Kg./m 0.286	 SC9A100 sup.vista mm. 56 Kg./m 0.506	 SC9A200 sup.vista mm. 147 Kg./m 0.976	 SC9A202 sup.vista mm. 132 Kg./m 0.725	<p>Nuova soluzione labirinto centrale</p> <div style="display: flex; justify-content: space-around;"> <div style="border: 1px solid black; padding: 5px; text-align: center;">  SC9A028 sup.vista mm. 103 Kg./m 0.524 </div> <div style="border: 1px solid black; padding: 5px; text-align: center;">  SC9A033 sup.vista mm. 112 Kg./m 0.591 </div> </div>		 SC9A012 sup.vista mm. 128 Kg./m 0.818					
 SC9A010 sup.vista mm. 119 Kg./m 0.733	 SC9A020 sup.vista mm. 111 Kg./m 0.605	 SC9A022 sup.vista mm. 122 Kg./m 0.806	 SC9A030 sup.vista mm. 113 Kg./m 0.722	 SC9A040 sup.vista mm. 104 Kg./m 0.615	 SC9A110 sup.vista mm. 102 Kg./m 0.584	 SC9A112 sup.vista mm. 111 Kg./m 0.665	 SC9A122 sup.vista mm. 106 Kg./m 0.656	 SC9A130 sup.vista mm. 97 Kg./m 0.575						

 SC9A003 sup.vista mm. 46 Kg./m 0.156	 SC9A004 sup.vista mm. 79 Kg./m 0.299	 SC9A005 sup.vista mm. 16 Kg./m 0.071	 SC9A016 sup.vista mm. 99 Kg./m 0.432	 SC9A026 sup.vista mm. 88 Kg./m 0.487	 SC9A027 sup.vista mm. 98 Kg./m 0.885	 SZ9C048 sup.vista mm. 163 Kg./m 2.141	 SZ9C049 sup.vista mm. 163 Kg./m 2.165	 SZ9C050 sup.vista mm. 163 Kg./m 2.217			
 SZ9A001 sup.vista mm. 31 Kg./m 0.127	 SZ9A002 sup.vista mm. 34 Kg./m 0.136	 SZ9A525 sup.vista mm. 48 Kg./m 0.282	 SZ9A511 sup.vista mm. 37 Kg./m 0.173	 SZ9A510 sup.vista mm. 41 Kg./m 0.186	 SZ9A527 sup.vista mm. 43 Kg./m 0.238	 SZ9C008 sup.vista mm. 0 Kg./m 0.561	 SZ9C030 sup.vista mm. 0 Kg./m 0.130	 SZ9C005 sup.vista mm. 34 Kg./m 0.315	 SZ9A016 sup.vista mm. 34 Kg./m 0.315	 SZ9A030 sup.vista mm. 16 Kg./m 0.204	 SZ9A526 sup.vista mm. 13.9 Kg./m 0.144
 SZ9A905 sup.vista mm. 45 Kg./m 3.416	 SZ9A077 sup.vista mm. 71 Kg./m 0.43	 SZ9A078 sup.vista mm. 46 Kg./m 0.336	 SZ9A079 sup.vista mm. 71 Kg./m 0.437	 SZ9A080 sup.vista mm. 80 Kg./m 0.537	 SZ9A081 sup.vista mm. 119 Kg./m 0.698	 SZ9A082 sup.vista mm. 170 Kg./m 0.952	 SZ9A066 sup.vista mm. 0 Kg./m 0.668	 SZ9A069 sup.vista mm. 0 Kg./m 0.851	 SCO3001 sup.vista mm. 0 Kg./m 0.668		
 SCO3003 sup.vista mm. 0 Kg./m 0.851	 SZ9A168 sup.vista mm. 120 Kg./m 1.6	 SZ9A170 sup.vista mm. 82 Kg./m 1.11	 SZ9A162 sup.vista mm. 67 Kg./m 0.92	 SZ9A075 sup.vista mm. 96 Kg./m 0.636	 SZ9A171 sup.vista mm. 73 Kg./m 0.656	 SZ9A068 sup.vista mm. 108 Kg./m 0.875	 S012 sup.vista mm. 82 Kg./m 0.001	 SZ9C018 sup.vista mm. 47 Kg./m 0.194	 SZ9C017 sup.vista mm. 118 Kg./m 1.441	 SZ9C016 sup.vista mm. 156 Kg./m 1.609	
 SZ9A110 sup.vista mm. 32 Kg./m 0.129	 SZ9C046 sup.vista mm. 129 Kg./m 1.835	 SZ9C015 sup.vista mm. 65 Kg./m 0.31	 SZ9C014 sup.vista mm. 106 Kg./m 1.192	 SZ9C013 sup.vista mm. 166 Kg./m 1.608	 SZ9C010 sup.vista mm. 24 Kg./m 0.153	 SZ9C009 sup.vista mm. 70 Kg./m 0.546	 SZ9C020 sup.vista mm. 0 Kg./m 0.807	 SZ9C021 sup.vista mm. 180 Kg./m 1.021	 SZ9C022 sup.vista mm. 190 Kg./m 1.073	 SZ9C012 sup.vista mm. 190 Kg./m 0.117	 SZ9C011 sup.vista mm. 163 Kg./m 1.631
 SZ9D002 sup.vista mm. 104 Kg./m 0.545	 SZ9D003 sup.vista mm. 114 Kg./m 0.599	 SZ9D004 sup.vista mm. 124 Kg./m 0.654	 SZ9D005 sup.vista mm. 144 Kg./m 0.762	 SZ9D006 sup.vista mm. 164 Kg./m 0.975	 SZ9D007 sup.vista mm. 183 Kg./m 1.214						
 SZ9D008 sup.vista mm. 198 Kg./m 1.452	 SZ9D009 sup.vista mm. 213 Kg./m 1.695	 SZ9D010 sup.vista mm. 238 Kg./m 2.029	 SZ9D220 sup.vista mm. 166 Kg./m 0.837	 SZ9D221 sup.vista mm. 206 Kg./m 1.120							

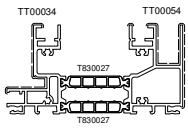

T141000
Kg/m 2.1970
Sup. in vista mm 188

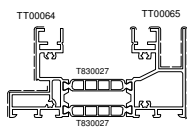

T141001
Kg/m 2.1450
Sup. in vista mm 190

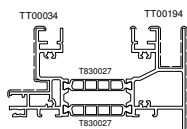

T141004
Kg/m 2.2780
Sup. in vista mm 219

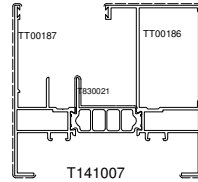

T141007
Kg/m 2.4780
Sup. in vista mm 273

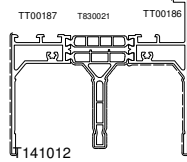

T141012
Kg/m 2.1190
Sup. in vista mm 248

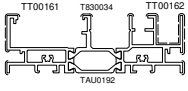

T141013
Kg/m 1.6720
Sup. in vista mm 116

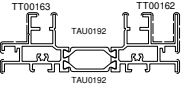

T141014
Kg/m 1.6910
Sup. in vista mm 132

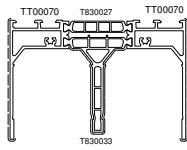

T141017
Kg/m 1.97
Sup. in vista mm 141

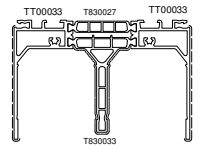

T141019
Kg/m 2.045
Sup. in vista mm 243

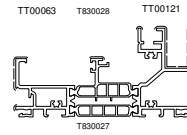

T141025
Kg/m 1.948
Sup. in vista mm 139

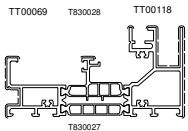

T141026
Kg/m 1.9220
Sup. in vista mm 172

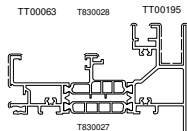

T141029
Kg/m 2.0350
Sup. in vista mm 171

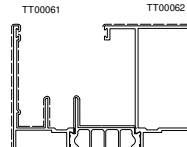

T141030
Kg/m 2.2730
Sup. in vista mm 317

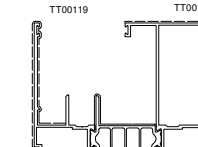

T141031
Kg/m 2.2570
Sup. in vista mm 297

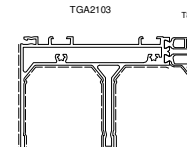

TGA1100
Kg/m 2.9430
Sup. in vista mm 351

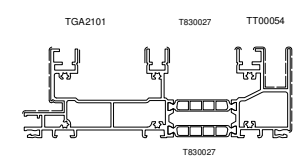

TGA1101
Kg/m 3.002
Sup. in vista mm 204

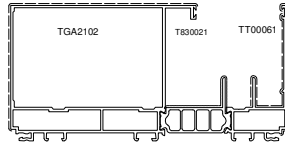

TGA1102
Kg/m 2.9490
Sup. in vista mm 363

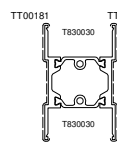

T141009
Kg/m 1.208
Sup. in vista mm 145

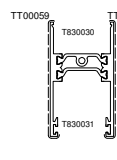

T141015
Kg/m 1.1380
Sup. in vista mm 143

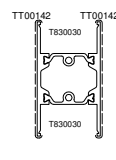

T141018
Kg/m 1.1380
Sup. in vista mm 143

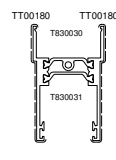

T141021
Kg/m 1.1580
Sup. in vista mm 146

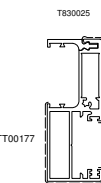

T141033
Kg/m 1.3840
Sup. in vista mm 158

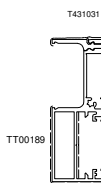

T141034
Kg/m 1.3480
Sup. in vista mm 178

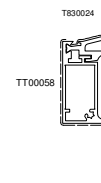

T141037
Kg/m 1.4230
Sup. in vista mm 214

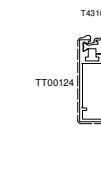

T141041
Kg/m 0.9630
Sup. in vista mm 93

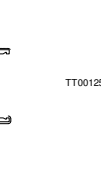

T141043
Kg/m 1.3930
Sup. in vista mm 148



T141038
Kg/m 1.4230
Sup. in vista mm 214

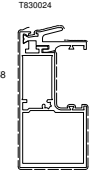

T141024
Kg/m 1.6480
Sup. in vista mm 262

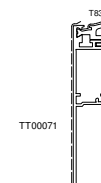

T141042
Kg/m 1.6180
Sup. in vista mm 196

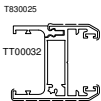

T141039
Kg/m 1.069
Sup. in vista mm 98

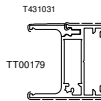

T141040
Kg/m 1.0390
Sup. in vista mm 202

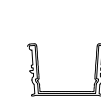

T431025
Kg/m 0.2230
Sup. in vista mm



T431024
Kg/m 0.099
Sup. in vista mm



T821001
Kg/m 0.14
Sup. in vista mm

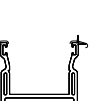

T821002
Kg/m 0.4210
Sup. in vista mm



T821003
Kg/m 0.2240
Sup. in vista mm

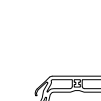

T821004
Kg/m 0.36
Sup. in vista mm



T821005
Kg/m 0.366
Sup. in vista mm



T821008
Kg/m 0.1970
Sup. in vista mm



T821009
Kg/m 0.1230
Sup. in vista mm



T821010
Kg/m 0.0310
Sup. in vista mm



T823000
Kg/m 0.0610
Sup. in vista mm



T823001
Kg/m 0.2150
Sup. in vista mm



T391006
Kg/m 0.4760
Sup. in vista mm 93



T391007
Kg/m 0.5510
Sup. in vista mm 108

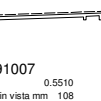

T591153
Kg/m 0.6450
Sup. in vista mm 127

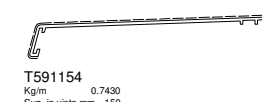

T591154
Kg/m 0.7430
Sup. in vista mm 150

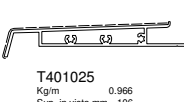

T401025
Kg/m 0.966
Sup. in vista mm 106



T401026
Kg/m 1.3010
Sup. in vista mm 145

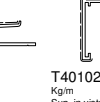

T401021
Kg/m 0.2970
Sup. in vista mm 50



T401022
Kg/m 0.4130
Sup. in vista mm 62



T401023
Kg/m 0.5190
Sup. in vista mm 82

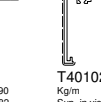

T401024
Kg/m 0.6060
Sup. in vista mm 102



T391010
Kg/m 0.19
Sup. in vista mm 44



T391011
Kg/m 0.211
Sup. in vista mm 48

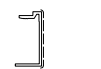

T391012
Kg/m 0.2180
Sup. in vista mm 51

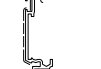

T591199
Kg/m 0.3020
Sup. in vista mm 42



T341000
Kg/m 0.1630
Sup. in vista mm 16



TGA4001
Kg/m 0.4140
Sup. in vista mm 27

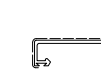

T341007
Kg/m 0.5620
Sup. in vista mm 108



T341012
Kg/m 0.2620
Sup. in vista mm 41



T341025
Kg/m 0.1930
Sup. in vista mm 47





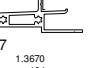





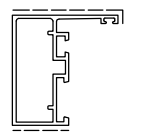
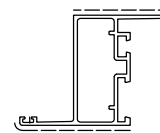
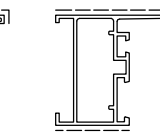
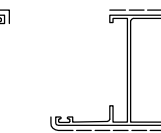
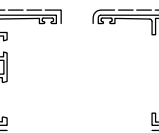
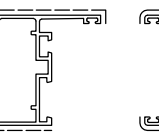
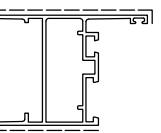
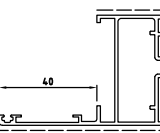
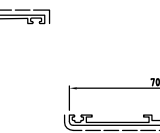
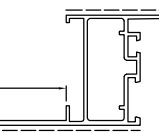
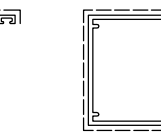
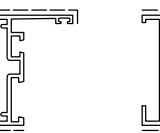
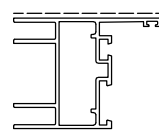
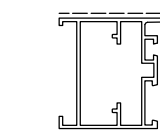
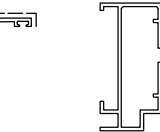
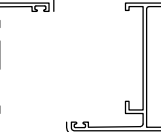
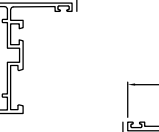
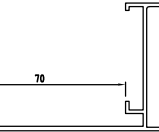
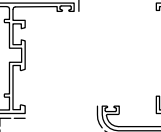
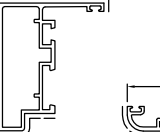
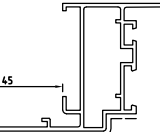
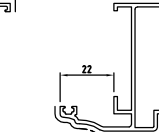
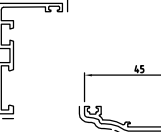
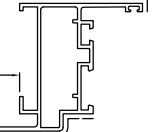
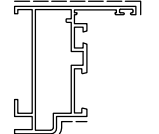
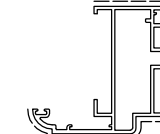
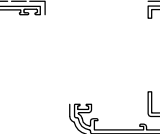
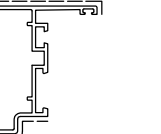
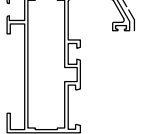
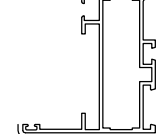
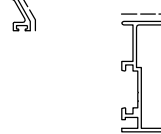
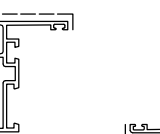
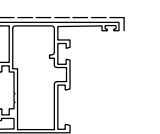
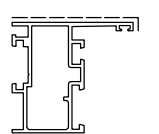
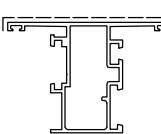
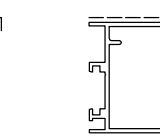
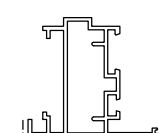
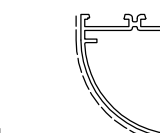
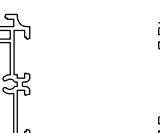
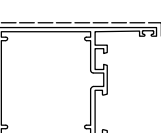
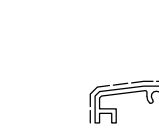

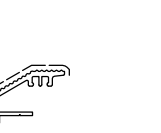
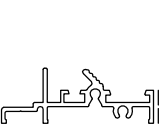
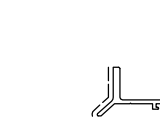
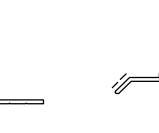
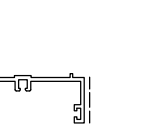
T401027
Kg/m 1.3670
Sup. in vista mm 134

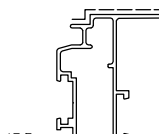
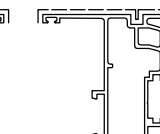
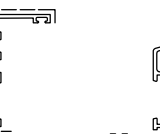
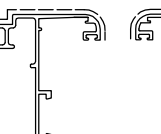
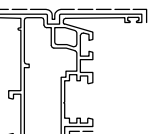
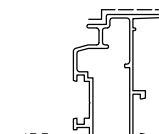
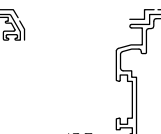
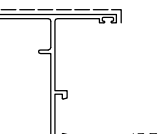
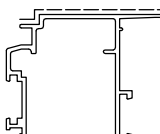
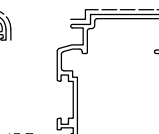
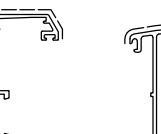
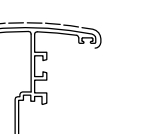
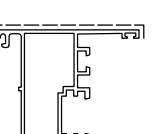
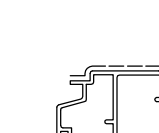
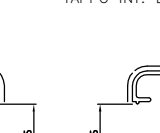
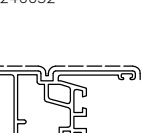
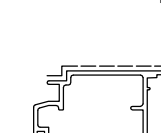

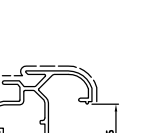
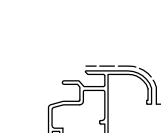
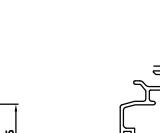
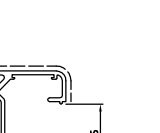
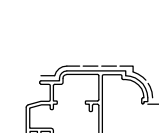
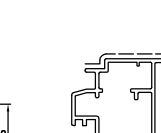
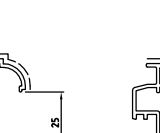
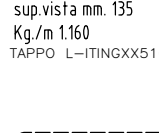
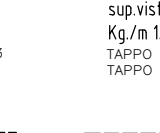
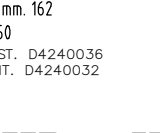
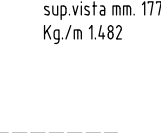
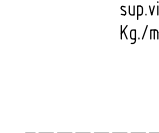
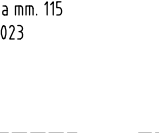
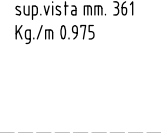

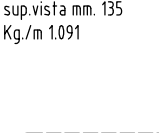







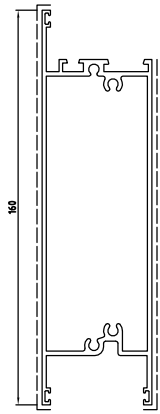
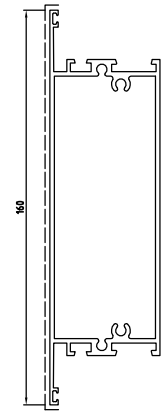
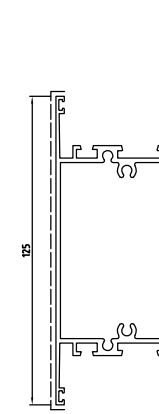
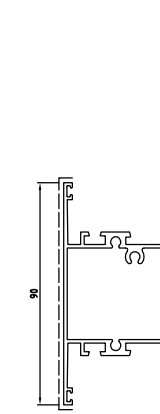
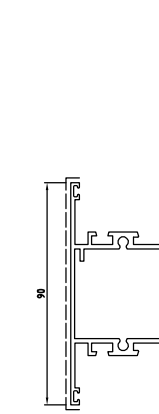
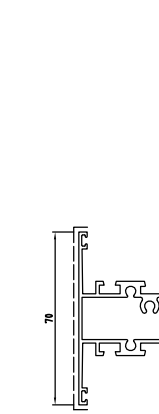
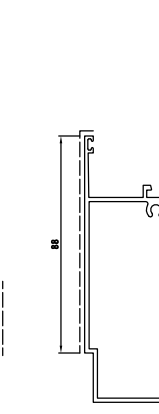
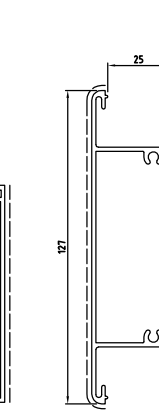
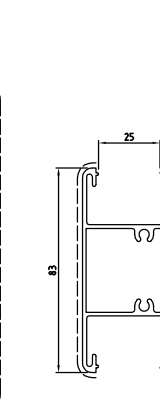
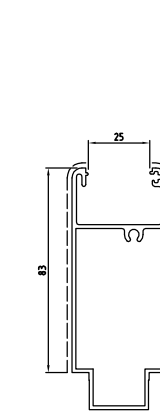
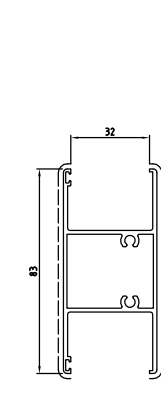
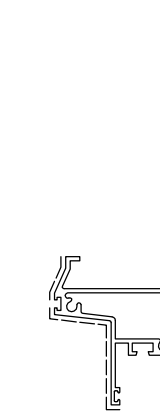

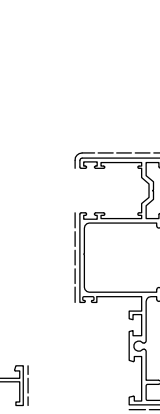

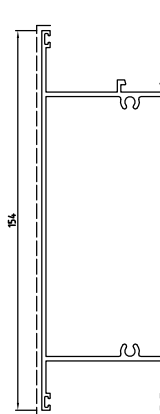
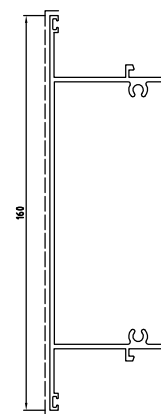
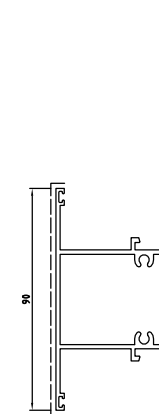
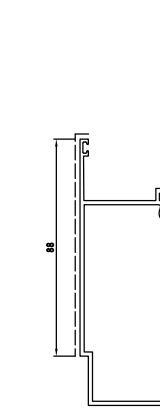
T401028
Kg/m 1.6740
Sup. in vista mm 122

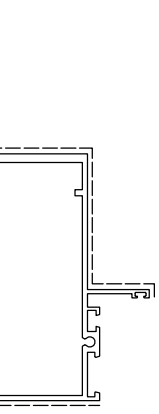
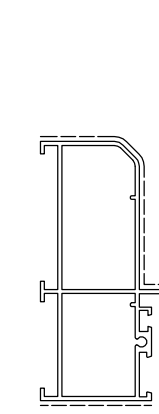
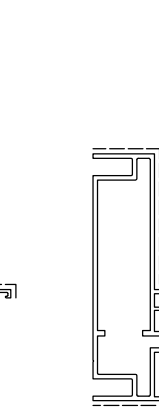
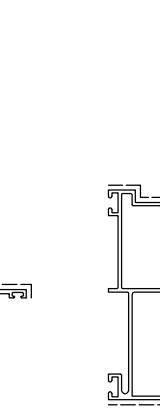
Tabellone 1-2

 D3210151 sup.vista mm. 69 Kg./m 0.718	 D3210163 sup.vista mm.95 Kg./m 0.818	 D3210062 sup.vista mm. 83 Kg./m 0.769	 D3210061 sup.vista mm. 109 Kg./m 0.883	 D3210063 sup.vista mm. 109 Kg./m 0.883	 D3210064 sup.vista mm. 134 Kg./m 0.972	 D3210116 sup.vista mm. 127 Kg./m 0.960	 D3210131 sup.vista mm.172 Kg./m 1.180	 D3210152 sup.vista mm. 158 Kg./m 1.047	 D3210182 sup.vista mm. 124 Kg./m 1.123	 D3210120 sup.vista mm. 153 Kg./m 1.225	 D3210121 sup.vista mm. 153 Kg./m 1.225	
 D3210123 sup.vista mm. 103 Kg./m 0.993	 D0026154 sup.vista mm. 103 Kg./m 0.912	 D3210105 sup.vista mm. 80 Kg./m 0.853	 D3210104 sup.vista mm. 109 Kg./m 0.956	 D3210142 sup.vista mm.165 Kg./m 1.204	 D3210167 sup.vista mm. 119 Kg./m 1.018	 D3210177 sup.vista mm.141 Kg./m 1.142	 D3210129 sup.vista mm. 117 Kg./m 0.991	 D3210141 sup.vista mm. 257 Kg./m 1.113	 D3210199 sup.vista mm. 88 Kg./m 0.867	 D3210175 sup.vista mm.118 Kg./m 1.018	 D3210200 sup.vista mm. 133 Kg./m 1.096	
 D3210193 sup.vista mm. 88 Kg./m 0.853	 D3210192 sup.vista mm. 120 Kg./m 1.021	 D3210176 sup.vista mm. 128 Kg./m 1.085	 D3210071 sup.vista mm. 93 Kg./m 0.964	 D3210070 sup.vista mm. 117 Kg./m 1.072	 D3210059 sup.vista mm. 82 Kg./m 0.821	 D3210053 sup.vista mm. 102 Kg./m 0.905	 D3210119 sup.vista mm. 82 Kg./m 0.821	 D3210079 sup.vista mm. 102 Kg./m 0.905	 D3210100 sup.vista mm.124 Kg./m 1.137	 D3210082 sup.vista mm. 147 Kg./m 1.223	 D3210083 sup.vista mm. 147 Kg./m 1.215	
 D3210066 sup.vista mm. 83 Kg./m 0.972	 D3210134 sup.vista mm. 92 Kg./m 0.991	 D3220031 sup.vista mm. 123 Kg./m 1.153	 D3220015 sup.vista mm.68 Kg./m 0.483	 D3210016 sup.vista mm.55 Kg./m 0.379	 D3210126 sup.vista mm.135 Kg./m 0.692	 D3210060 sup.vista mm. 20 Kg./m 0.340	 D3220033 sup.vista mm. 38 Kg./m 0.402	 D3220024 sup.vista mm.53 Kg./m 0.196	 D3091045 kg./m. 0.210 sup. in vista mm. 34 TAPPO SX D4040029 TAPPO DX D4040030	 D3220022 sup.vista mm. 30 Kg./m 0.424	 D3220023 sup.vista mm. 30 Kg./m 0.454	
 D3210047 sup.vista mm. 98 Kg./m 0.934	 D3210048 sup.vista mm. 135 Kg./m 1.133 TAPPO EST. D4240036 TAPPO INT. D4240032	 D3210172 sup.vista mm. 107 Kg./m 0.980	 D3210136 sup.vista mm.205 Kg./m 1.177 TAPPO EST. D4240036 TAPPO INT. D4240032	 D3210111 sup.vista mm. 101 Kg./m 0.976	 D3210049 sup.vista mm. 147 Kg./m 1.285	 D3210173 sup.vista mm. 152 Kg./m 1.320	 D3210156 sup.vista mm. 148 Kg./m 1.318	 D3210137 sup.vista mm.78 Kg./m 0.915 TAPPO D4240043	 D3210081 sup.vista mm. 78 Kg./m 0.875 TAPPO D4240041	 D3210080 sup.vista mm. 82 Kg./m 0.845 TAPPO D4240042	 D3210091 sup.vista mm. 80 Kg./m 0.909	 D3210090 sup.vista mm. 134 Kg./m 1.250
 D3210073 sup.vista mm. 135 Kg./m 1.160 TAPPO L-ITINGXX5103	 D3210074 sup.vista mm. 162 Kg./m 1.350 TAPPO EST. D4240036 TAPPO INT. D4240032	 D3210178 sup.vista mm. 177 Kg./m 1.482	 D3210183 sup.vista mm. 115 Kg./m 1.023	 D0023149 sup.vista mm. 361 Kg./m 0.975	 D3210135 sup.vista mm.137 Kg./m 1.172 TAPPO L-ITINGXX5103	 D3210194 sup.vista mm. 135 Kg./m 1.091	 D3210201 sup.vista mm.145 Kg./m 1.269	 D3210023 sup.vista mm. 135 Kg./m 1.193	 D3210204 sup.vista mm.133 Kg./m 1.169	 D3210198 sup.vista mm. 158 Kg./m 1.291	 D3210159 sup.vista mm. 157 Kg./m 1.296	
 D3210158 sup.vista mm. 110 Kg./m 0.919	 D3210188 sup.vista mm. 115 Kg./m 0.972	 D3210133 sup.vista mm. 115 Kg./m 0.962	 D3210052 sup.vista mm.151 Kg./m 1.266	 D3210162 sup.vista mm. 157 Kg./m 1.293	 D3210161 sup.vista mm. 183 Kg./m 1.423 TAPPO EST. D4240032 TAPPO INT. D4240034	 D3210180 sup.vista mm. 160 Kg./m 1.299	 D3220025 sup.vista mm. 153 Kg./m 1.119 TAPPO D4240033	 D3220026 sup.vista mm. 153 Kg./m 1.119 TAPPO D4240033	 D3220028 sup.vista mm. 56 Kg./m 0.640	 D3220027 sup.vista mm. 14 Kg./m 0.193		

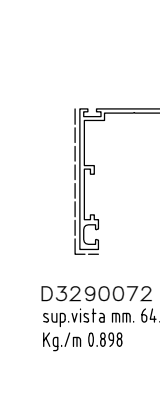
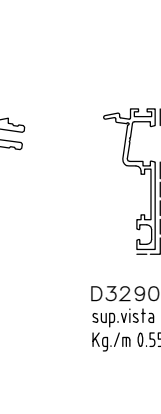
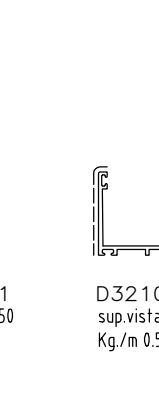
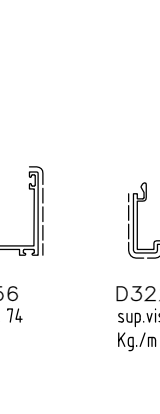
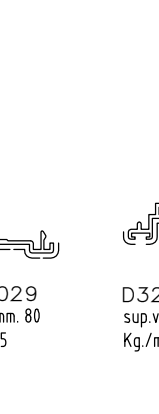
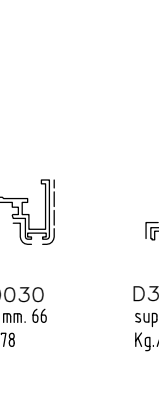
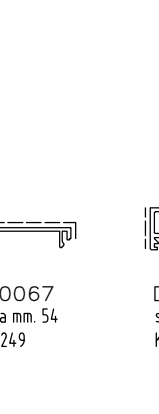
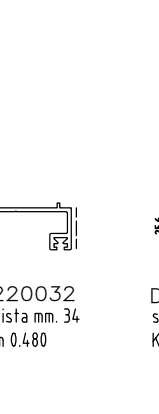
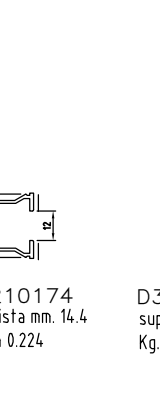
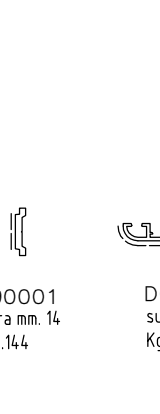
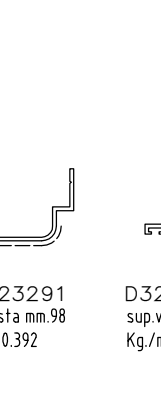
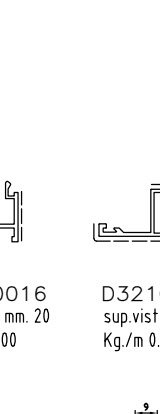
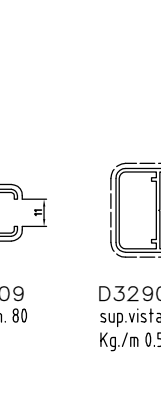
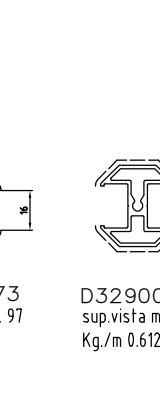
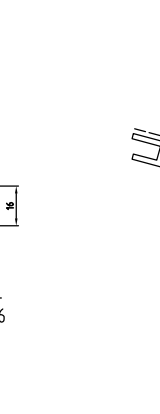
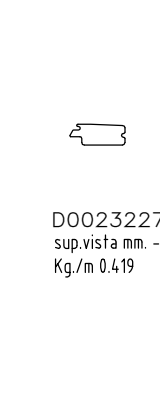
**NB: bilico disponibile solo come profili.
Ferramenta e frizioni non più commercializzate da DOMAL.**

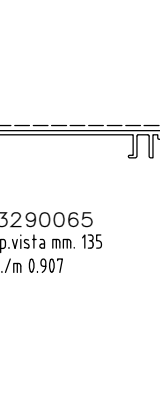
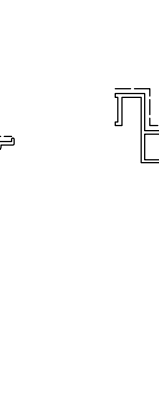
Data: LUGLIO 2013 Doc No. DOC-0000872169

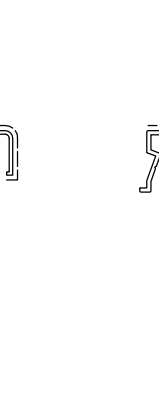
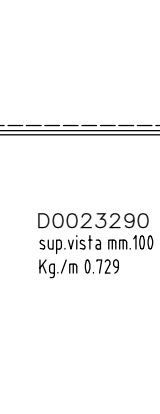
 D3220021 sup.vista mm. 314 Kg./m 2.198	 D3210088 sup.vista mm.287 Kg./m 2.134	 D3210114 sup.vista mm.207 Kg./m 1.795	 D3210117 sup.vista mm.147 Kg./m 1.423	 D3210069 sup.vista mm.147 Kg./m 1.314	 D3210092 sup.vista mm.107 Kg./m 1.058	 D3210094 sup.vista mm. 179 Kg./m 1.396	 D3210075 sup.vista mm. 271 Kg./m 1.755 TAPPO D4240035	 D3210076 sup.vista mm. 181 Kg./m 1.287 TAPPO D4240035	 D3210127 sup.vista mm. 170 Kg./m 1.247	 D3210206 sup.vista mm. 176 Kg./m 1.123	 D3210046 sup.vista mm. 136 Kg./m 1.277	 D3210164 sup.vista mm.55 Kg./m 0.588	 D3210190 sup.vista mm. 151 Kg./m 1.801 TAPPO D4240117	 D3210017 sup.vista mm. 31 Kg./m 0.121
 D3220020 sup.vista mm. 298 Kg./m 2.014	 D3210086 sup.vista mm.287 Kg./m 2.036	 D3210087 sup.vista mm.147 Kg./m 1.287	 D3210085 sup.vista mm. 179 Kg./m 1.361	 D3210093 sup.vista mm. 261 Kg./m 2.268	 D0026115 sup.vista mm.168 Kg./m 1.704	 D3210097 sup.vista mm. 138 Kg./m 1.617	 D0026105 sup.vista mm.122 Kg./m 1.288	 D3210171 sup.vista mm.136 Kg./m 2.060	 D3210057 sup.vista mm. 146 Kg./m 1.392	 D3210058 sup.vista mm. 144 Kg./m 1.080	 D3210018 sup.vista mm. 38 Kg./m 0.143	 D3210197 sup.vista mm. 210 Kg./m 2.346		
 D3290072 sup.vista mm. 64.5 Kg./m 0.898	 D3290071 sup.vista mm. 50 Kg./m 0.551	 D3210056 sup.vista mm. 74 Kg./m 0.559	 D3220029 sup.vista mm. 80 Kg./m 0.375	 D3220030 sup.vista mm. 66 Kg./m 0.478	 D3210067 sup.vista mm. 54 Kg./m 0.249	 D3220032 sup.vista mm. 34 Kg./m 0.480	 D3210174 sup.vista mm. 14.4 Kg./m 0.224	 D3290001 sup.vista mm. 14 Kg./m 0.144	 D0023291 sup.vista mm.98 Kg./m 0.392	 D3220016 sup.vista mm. 20 Kg./m 0.300	 D3210109 sup.vista mm. 80 Kg./m 0.412	 D3290073 sup.vista mm. 97 Kg./m 0.507	 D3290074 sup.vista mm. 76 Kg./m 0.612	
 D0023227 sup.vista mm. - Kg./m 0.419	 D0023173 sup.vista mm. - Kg./m 0.456	 D3290065 sup.vista mm. 135 Kg./m 0.907	 D3290066 sup.vista mm. 224 Kg./m 1.291 TAPPO D6240015	 D0023290 sup.vista mm.100 Kg./m 0.729	 D0023289 sup.vista mm.60 Kg./m 0.481	 D3290080 sup.vista mm. 248 Kg./m 0.973	 D3290063 sup.vista mm. 154 Kg./m 0.942 TAPPO D0080D04	 D3290062 sup.vista mm. 278 Kg./m 1.968 TAPPO D0080D04						

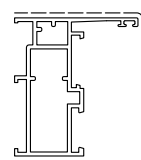

D3210288
sup.vista mm. 81
Kg./m 1.002

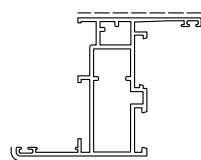

D3210287
sup.vista mm. 109
Kg./m 1.134

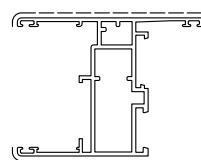

D3210299
sup.vista mm. 136
Kg./m 1.256

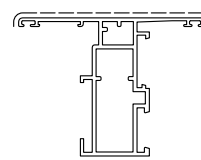

D3210300
sup.vista mm. 109
Kg./m 1.137

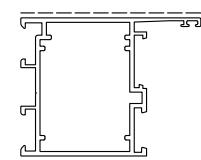

D3210290
sup.vista mm. 127
Kg./m 1.342

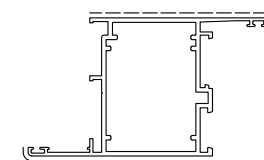

D3210289
sup.vista mm. 152
Kg./m 1.396

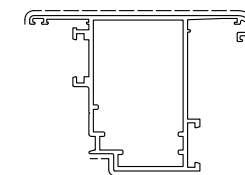

D3210302
sup.vista mm. 152
Kg./m 1.464

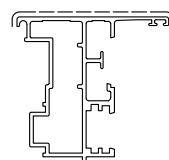

D3210293
sup.vista mm. 81
Kg./m 1.185
TAPPO EST. D4240023
TAPPO INT. D4240025

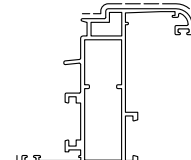

D3210291
sup.vista mm. 105
Kg./m 1.215

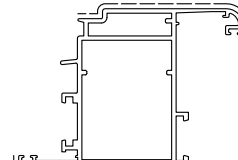

D3210292
sup.vista mm. 149
Kg./m 1.636

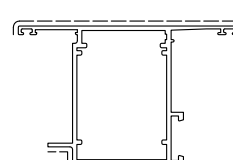

D3220069
sup.vista mm. 156
Kg./m 1.301
TAPPO D0015D30

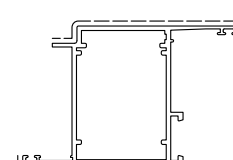

D3220068
sup.vista mm. 152
Kg./m 1.272
TAPPO D0015D30

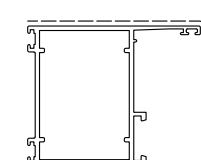

D3220070
sup.vista mm. 121
Kg./m 1.188

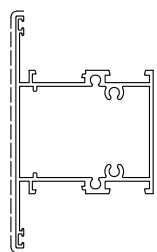

D3210294
sup.vista mm. 96
Kg./m 1.391

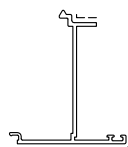

D3220073
sup.vista mm. 60
Kg./m 0.481

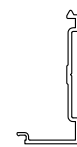

D3220072
sup.vista mm. 22
Kg./m 0.362

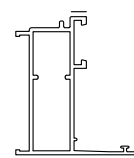

D3210307
sup.vista mm. 60
Kg./m 0.851



D0034373
sup.vista mm. 13.5
Kg./m 0.206

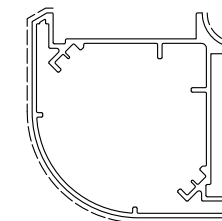

D0024499
sup.vista mm. 174
Kg./m 2.031



D3290001
sup.vista mm. 14
Kg./m 0.144

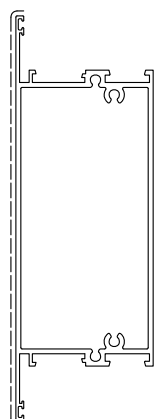

D3210295
sup.vista mm. 236
Kg./m 2.403

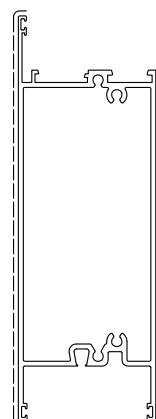

D3220071
sup.vista mm. 311
Kg./m 2.587



D3210311
sup.vista mm. 74
Kg./m 0.604



D3091045
kg./m. 0.210
sup. in vista mm. 34
TAPPO SX D4040029
TAPPO DX D4040030

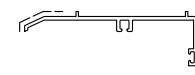

D0024474
sup.vista mm. 35
Kg./m 0.424

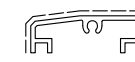

D3220015
sup.vista mm.68
Kg./m 0.483

CAVA 32

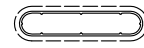

D0050013
sup.vista mm. 111
Kg./m 0.240



D6290118



D3260266
sup.vista mm. 76
Kg./m 0.452
TAPPO D4240172

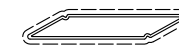

D3260323
sup.vista mm. 136
Kg./m 0.358



D6702000



D3260324
sup.vista mm. 104
Kg./m 0.523

CAVA 31

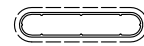

D0050013
sup.vista mm. 111
Kg./m 0.240



D6290201

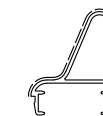

D3260325
sup.vista mm. 86
Kg./m 0.462
TAPPO D4240172



D3260323
sup.vista mm. 136
Kg./m 0.358



D6290202

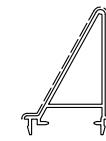

D3260326
sup.vista mm. 103
Kg./m 0.508

Tabellone 1-2

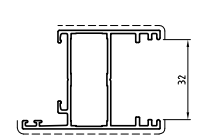

D3260174
sup.vista mm. 108
Kg./m 0.748
TAPPO D0030D27

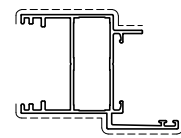

D3260175
sup.vista mm. 137
Kg./m 0.853
TAPPO D0030D27
TAPPO D0040D07 T/Z

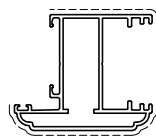

D3260194
sup.vista mm. 116
Kg./m 0.994
TAPPO D0030D75

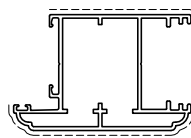

D3260195
sup.vista mm. 148
Kg./m 1.191
TAPPO D0030D76

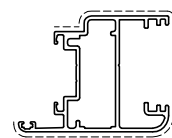

D3260241
sup.vista mm. 146
Kg./m 1.031
TAPPO L-ITLC0001

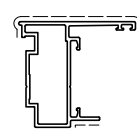

D3210242
sup.vista mm. 74
Kg./m 0.662
TAPPO D0040D08
TAPPO D0030D17

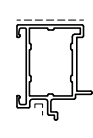

D3260199
sup.vista mm. 45
Kg./m 0.538
TAPPO D0030D72

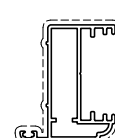

D3260191
sup.vista mm. 137
Kg./m 0.726
TAPPO D0030D91

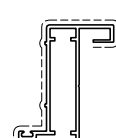

D3260193
sup.vista mm. 161
Kg./m 0.840
TAPPO D0030D92

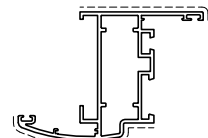

D3210175
sup.vista mm. 118
Kg./m 1.018

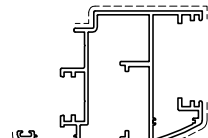

D3260184
sup.vista mm. 150
Kg./m 1.323
TAPPO D013D100

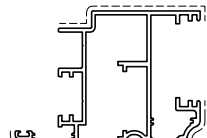

D3260057
sup.vista mm. 161
Kg./m 1.340
TAPPO D4240012

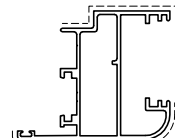

D3260045
sup.vista mm. 130
Kg./m 1.040
TAPPO D0013D44

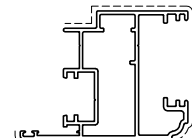

D3260186
sup.vista mm. 142
Kg./m 1.153
TAPPO D0030D85

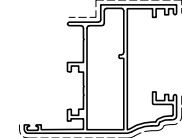

D3260179
sup.vista mm. 129
Kg./m 1.040

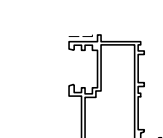

D3210080
sup.vista mm. 82
Kg./m 0.845
TAPPO D4240042
TAPPO D4240015 CHIUDI TUBOLARITA'

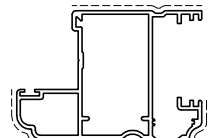

D3260067
sup.vista mm. 156
Kg./m 1.315
TAPPO D4240004

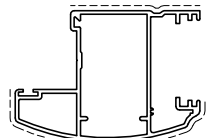

D3260068
sup.vista mm. 147
Kg./m 1.258
TAPPO D4240003



D3260037
sup.vista mm. 84
Kg./m 0.621
TAPPO D4240002



D3260066
sup.vista mm. 43
Kg./m 0.454
TAPPO D4240001

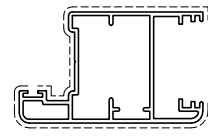

D3260055
sup.vista mm. 210
Kg./m 1.208
TAPPO D0033D01

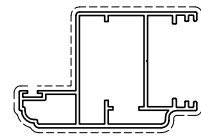

D3260196
sup.vista mm. 210
Kg./m 1.112
TAPPO D0030D73

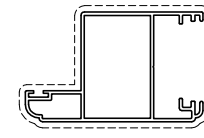

D3260030
sup.vista mm. 189
Kg./m 0.967
TAPPO D0030D74

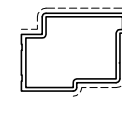

D3260182
sup.vista mm. 101
Kg./m 0.578
TAPPO D0033D02

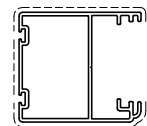

D3260198
sup.vista mm. 145
Kg./m 0.813
TAPPO D0030D74

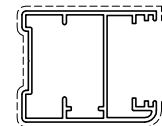

D3260180
sup.vista mm. 190
Kg./m 0.996
TAPPO D0033D01

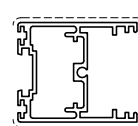

D3260183
sup.vista mm. 104
Kg./m 0.996



D3250031
sup.vista mm. 37
Kg./m 0.211

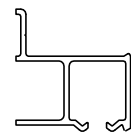

D3260204
sup.vista mm. =
Kg./m 0.904

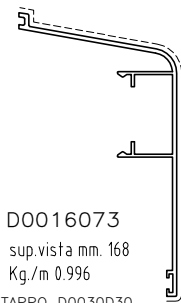

D0016073
sup.vista mm. 168
Kg./m 0.996
TAPPO D0030D30

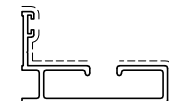

D3260203
sup.vista mm. 152
Kg./m 0.788
TAPPO D00GE005



D3260208
sup.vista mm. 61
Kg./m 0.329

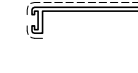

D3260211
sup.vista mm. 57
Kg./m 0.271



D3290001
sup.vista mm. 14
Kg./m 0.144



D3210279
sup.vista mm. 23
Kg./m 0.165

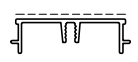

D3260218
sup.vista mm. 45
Kg./m 0.354

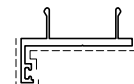

D3260209
sup.vista mm. 0.537
Kg./m 81

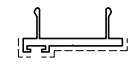

D3260210
sup.vista mm. 47
Kg./m 0.432



D3260216
sup.vista mm. 36
Kg./m 0.201



D3260042
sup.vista mm. 42
Kg./m 0.208



D3260207
sup.vista mm. 7
Kg./m 0.176

D3260040
sup.vista mm. 165
Kg./m 1.208
TAPPO D4240074

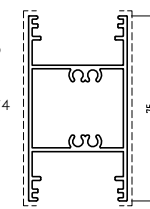

D3260039
sup.vista mm. 182
Kg./m 1.509
TAPPO D4240075

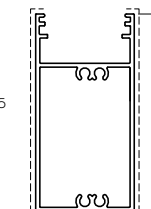

D3260041
sup.vista mm. 272
Kg./m 1.785
TAPPO D4240074

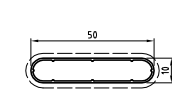
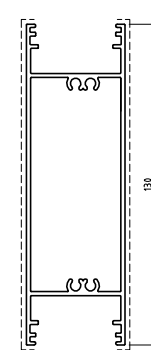

D0050013
sup.vista mm. 111
Kg./m 0.240



D6290118

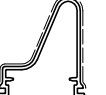

D3260266
sup.vista mm. 92
Kg./m 0.422
TAPPO D4240172

CAVA 32

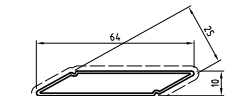

D3260323
sup.vista mm. 136
Kg./m 0.358



D6702000



D3260324
sup.vista mm. 104
Kg./m 0.523

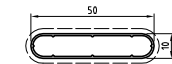

D0050013
sup.vista mm. 111
Kg./m 0.240



D6290201

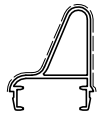

D3260325
sup.vista mm. 86
Kg./m 0.462
TAPPO D4240172

CAVA 31

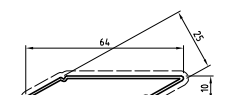

D3260323
sup.vista mm. 136
Kg./m 0.358



D6290202



D3260326
sup.vista mm. 103
Kg./m 0.508

Data: GENNAIO 2016

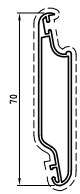

D3260051
sup.vista mm.157
Kg./m 0.490
TAPPO D6290099

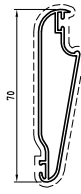

D3260052
sup.vista mm. 160
Kg./m 0.502
TAPPO D6290096

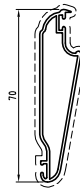

D3260053
sup.vista mm. 158
Kg./m 0.494
TAPPO D6290096

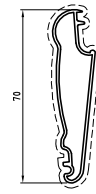

D3260063
sup.vista mm. 175
Kg./m 0.495
TAPPO D6290096

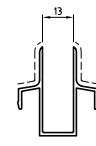

D3260050
sup.vista mm. 47
Kg./m 0.382



D3280007
sup.vista mm. 21
Kg./m 0.311



D3260049
sup.vista mm. 108
Kg./m 0.375

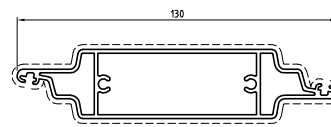

D3260043
sup.vista mm. 293
Kg./m 1.492
TAPPO D4240084



D3B80005
sup.vista mm. 16
Kg./m 0.273

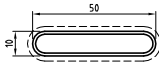

D3280001
sup.vista mm. 0.347
Kg./m 111
TAPPO D4240018 (CAVA 7)
TAPPO D4240086 (CAVA 32)

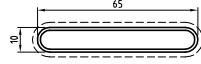

D3280002
sup.vista mm. 141
Kg./m 0.448
TAPPO D4240019 (CAVA 7)
TAPPO D4240085 (CAVA 32)



D3260129
sup.vista mm. 85
Kg./m 0.405

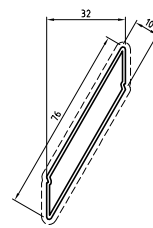

D3260224
sup.vista mm. 160
Kg./m 0.505

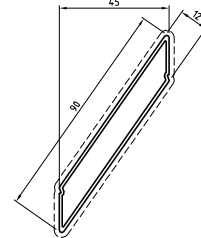

D3260225
sup.vista mm. 190
Kg./m 0.605

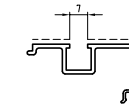

D3260212
sup.vista mm. 54
Kg./m 0.378

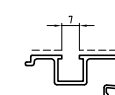

D0026187
sup.vista mm. 44
Kg./m 0.327

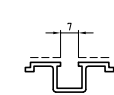

D3280006
sup.vista mm. 25
Kg./m 0.262



D3280005
sup.vista mm. 102
Kg./m 0.358

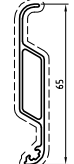

D3280003
sup.vista mm. 166
Kg./m 0.401
TAPPO D4240022



D3260221
sup.vista mm. 104
Kg./m 0.356



D3260223
sup.vista mm. 185
Kg./m 0.516

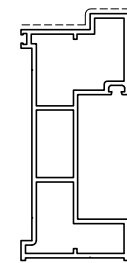

D3B 10052
sup.vista mm. 98
Kg./m 1.783

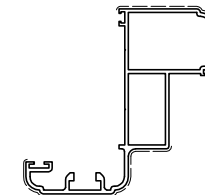

D3B 60016
sup.vista mm. 147
Kg./m 1.248

N.B.:
le cerniere non sono fornite da Domal

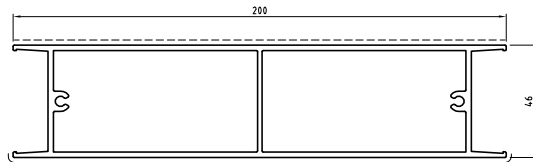

D3220091
sup.vista mm. 405
Kg./m 3.208



D3260206
sup.vista mm. 196
Kg./m 0.991

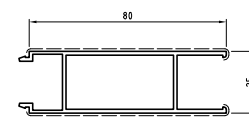

D0017891
sup.vista mm. 166
Kg./m 0.869

FRANGISOLE

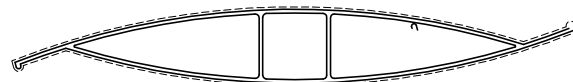

D0034640
sup.vista mm. 472
Kg./m 1.933
TAPPO D030D300
REGISTRO D30D301



D0031931
sup.vista mm. 73
Kg./m 0.295



D0031932
sup.vista mm. 431
Kg./m 1.164



D0011006
sup.vista mm. 136
Kg./m 0.310

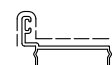

D3260038
sup.vista mm. 61
Kg./m 0.213



D3260011
sup.vista mm. 31
Kg./m 0.145

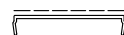

D3260010
sup.vista mm. 45
Kg./m 0.194

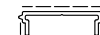

D3260042
sup.vista mm. 42
Kg./m 0.208



D3260024
sup.vista mm. 42
Kg./m 0.270



D3290001
sup.vista mm. 14
Kg./m 0.144

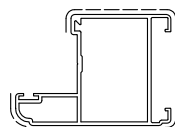

D3260016
sup.vista mm. 128
Kg./m 0.950
TAPPO D4240069

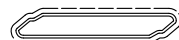

D3260047
sup.vista mm. 139
Kg./m 0.402



D3260048
sup.vista mm. 189
Kg./m 0.583

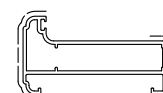

D3260013
sup.vista mm. 72
Kg./m 0.686

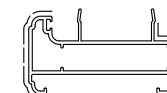

D3260014
sup.vista mm. 77
Kg./m 0.756

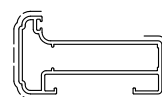

D3260028
sup.vista mm. 91
Kg./m 0.734
TAPPO D4240068
TAPPO D4240083

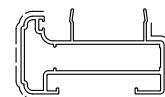

D3260029
sup.vista mm. 97
Kg./m 0.805
TAPPO D4240068
TAPPO D4240083

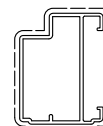

D3260017
sup.vista mm. 112
Kg./m 0.610

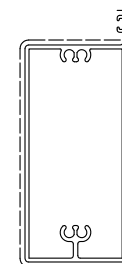

D3260035
sup.vista mm. 270
Kg./m 1.366
TAPPO D4240065
TAPPO D4240064

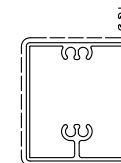

D3260034
sup.vista mm. 190
Kg./m 0.940
TAPPO D4240065
TAPPO D4240064

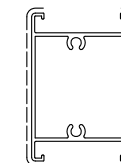

D3260026
sup.vista mm. 140
Kg./m 0.891
TAPPO D4240064

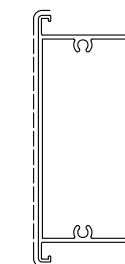

D3260025
sup.vista mm. 220
Kg./m 1.318
TAPPO D4240064

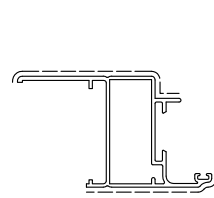

D0050025
sup.vista mm. 134
kg/m 0.905

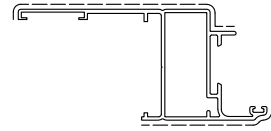

D3260036
sup.vista mm. 155
kg/m 0.992

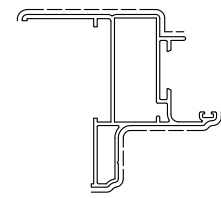

D0050027
sup.vista mm. 151
kg/m 1.121

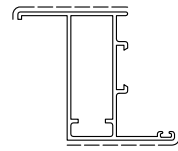

D0050002
sup.vista mm. 95
kg/m 0.845



D0050012
sup.vista mm. 138
kg/m 0.435

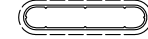

D0050013
sup.vista mm. 111
kg/m 0.240



D3280002
sup.vista mm. 141
kg/m 0.448



D0050016
sup.vista mm. 168
kg/m 0.554

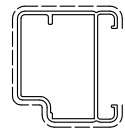

D0050029
sup.vista mm. 128
kg/m 0.656

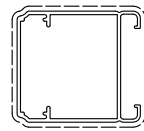

D0050030
sup.vista mm. 152
kg/m 0.764
TAPPO D00AW402

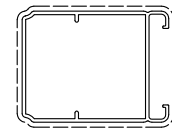

D0050031
sup.vista mm. 169
kg/m 0.805
TAPPO D00AW403

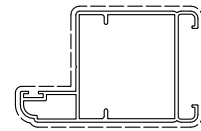

D0050044
sup.vista mm. 193
kg/m 0.948
TAPPO D00AW450

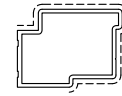

D3260182
sup.vista mm. 101
Kg./m 0.578
TAPPO D0033D02



D0050014
sup.vista mm. 60
kg/m 0.545



D0050017
sup.vista mm. 49
kg/m 0.432
TAPPO D00AW303



D0050034
sup.vista mm. 94
kg/m 0.497
TAPPO D00AW303

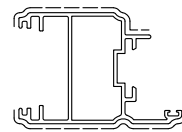

D0050050
sup.vista mm. 139
kg/m 0.999
TAPPO D4240058

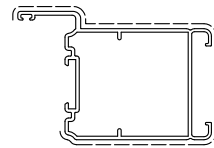

D0050028
sup.vista mm. 158
kg/m 1.015
TAPPO D00AW403
TAPPO D00AW304 (T/Z)

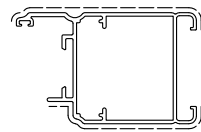

D0050026
sup.vista mm. 138
kg/m 0.986
TAPPO D00AW402
TAPPO D00AW421 (T/Z)

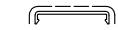

D0050038
sup.vista mm. 40
kg/m 0.211

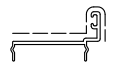

D3260038
sup.vista mm. 61
kg/m 0.213



D0050052
sup.vista mm. 40
kg/m 0.346



D3290080
sup.vista mm. 248
Kg./m 0.937

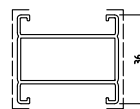

D0050035
sup.vista mm. 98
kg/m 0.594
TAPPO D00AW600

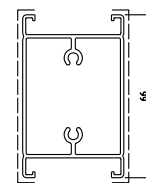

D0050043
sup.vista mm. 151
kg/m 0.988
TAPPO D00AW302 (SPORTELLO)
TAPPO D00AW401 (FISSO)

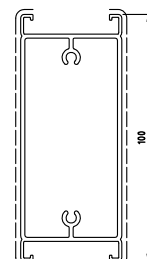

D0050032
sup.vista mm. 219
kg/m 1.420
TAPPO D00AW302 (SPORTELLO)
TAPPO D00AW401 (FISSO)

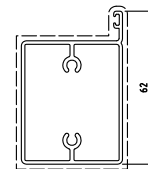

D0050036
sup.vista mm. 210
kg/m 0.888
TAPPO D00AW302 (SPORTELLO)
TAPPO D00AW401 (FISSO)

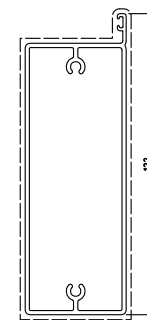

D0050033
sup.vista mm. 325
kg/m 1.588
TAPPO D00AW302 (SPORTELLO)
TAPPO D00AW401 (FISSO)

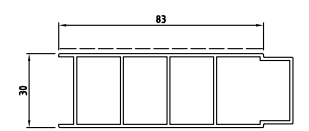

D3290132
sup.vista mm. 186
kg/m 1.126

↑
Aggiunti il 22-11-16

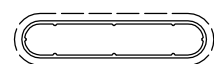

D0050013
sup.vista mm. 111
Kg./m 0.240

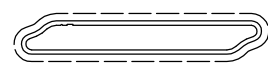

D0050012
sup.vista mm. 138
Kg./m 0.435



D0050016
sup.vista mm. 168
Kg./m 0.554



D0050014
sup.vista mm. 60
Kg./m 0.545

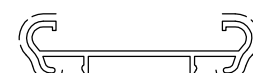

D0050017
sup.vista mm. 49
Kg./m 0.432

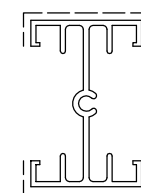

D0050005
sup.vista mm. 98
Kg./m 0.653

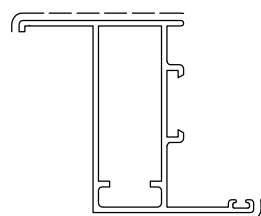

D0050002
sup.vista mm. 95
Kg./m 0.845

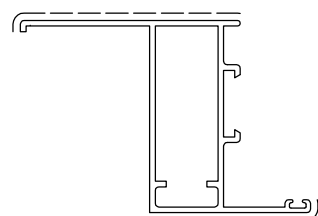

D0050023
sup.vista mm. 110
Kg./m 0.907

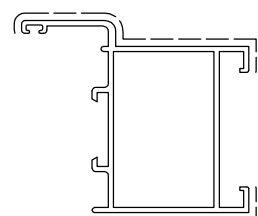

D0050003
sup.vista mm. 128
Kg./m 0.867
TAPPO D00AW042

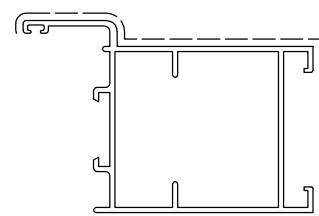

D0050008
sup.vista mm. 162
Kg./m 1.048
TAPPO D00AW043

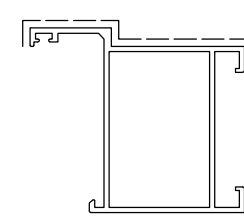

D0050021
sup.vista mm. 124
Kg./m 0.813

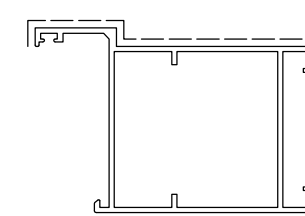

D0050020
sup.vista mm. 158
Kg./m 0.969



D0050060
sup.vista mm. 0
Kg./m 0.219
CLIP L-ITEPFBA67

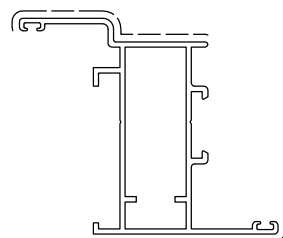

D0026214
sup.vista mm. 112
Kg./m 0.923

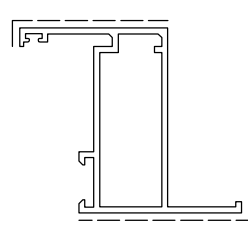

D0052217
sup.vista mm. 85
Kg./m 0.856

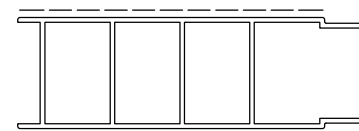

D3290132
sup.vista mm. 186
Kg./m 1.126

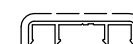

D0050011
sup.vista mm. 41
Kg./m 0.132



D3290001
sup.vista mm. 14
Kg./m 0.144



D0050010
sup.vista mm. 70
Kg./m 0.267

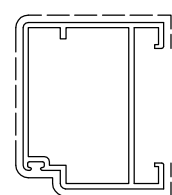

D0050015
sup.vista mm. 132
Kg./m 0.675

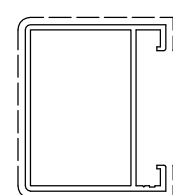

D0050004
sup.vista mm. 135
Kg./m 0.653
TAPPO D00AW042

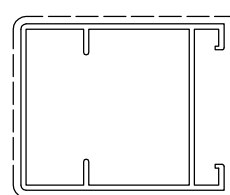

D0050009
sup.vista mm. 169
Kg./m 0.832
TAPPO D00AW043

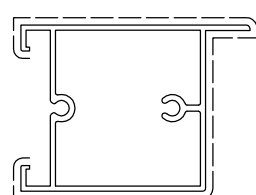

D0050024
sup.vista mm. 187
Kg./m 0.918
TAPPO D0096V89

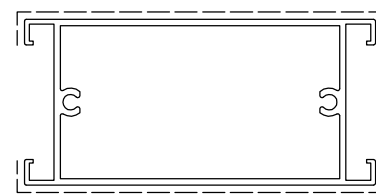

D0050039
sup.vista mm. 218
Kg./m 1.425

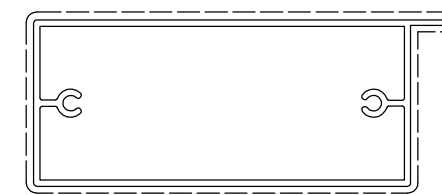

D0050007
sup.vista mm. 318
Kg./m 1.550

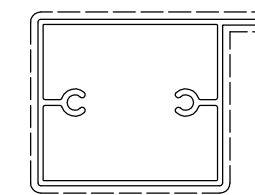

D0050006
sup.vista mm. 212
Kg./m 0.918
TAPPO D0096V88

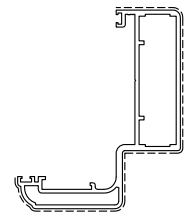

D3260268
sup.vista mm. 178
Kg./m 1.337

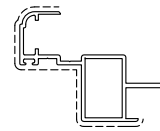

D3280020
sup.vista mm. 111
Kg./m 0.689



D3260237
sup.vista mm. 28
Kg./m 0.143



D3260243
sup.vista mm. 160
Kg./m 0.373
TAPPO 0030D89

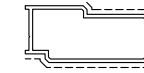

D3260202
sup.vista mm. 99
Kg./m 0.526
TAPPO D0030D90

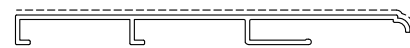

D3280022
sup.vista mm. 164
Kg./m 1.104



D3565000 (Ex D3280021)
sup.vista mm. 163
Kg/m 1,232

Correzione del
19-10-16



D3290131
sup.vista mm. 182
Kg./m 0.712

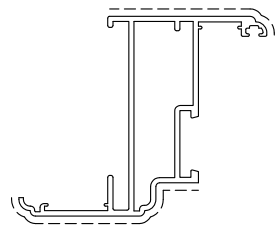

D3260022
Kg./m 0.867
sup.vista mm. 104

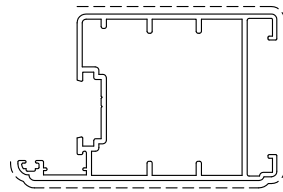

D3260015
Kg./m 0.986
sup.vista mm. 140
TAPPO D4240070

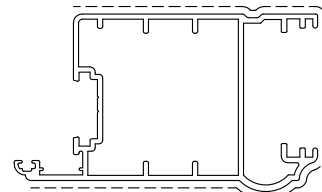

D3260018
Kg./m 1.172
sup.vista mm. 163
TAPPO D4240071

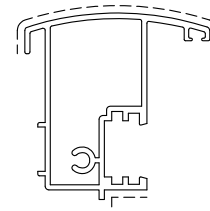

D3260027
Kg./m 0.886
sup.vista mm.77
TAPPO D4240072 DX
TAPPO D4240073 SX

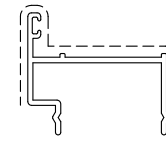

D3260012
Kg./m 0.397
sup.vista mm. 94

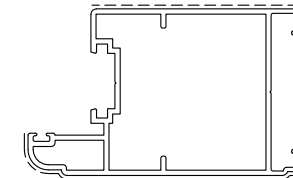

D3260262
kg/m. 1.049
sup. in vista mm.148
TAPPO D4240153

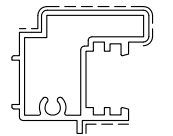

D3260263
kg/m. 0.641
sup. in vista mm.47
TAPPO D4240148 DX
TAPPO D4240149 SX

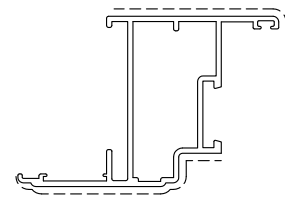

D3260019
Kg./m 0.832
sup.vista mm. 111

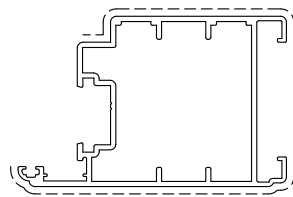

D3260020
Kg./m 1.045
sup.vista mm. 152
TAPPO D4240077

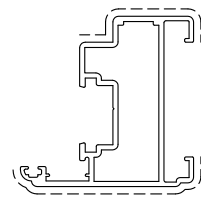

D3260021
Kg./m 0.780
sup.vista mm. 102
TAPPO D4240076

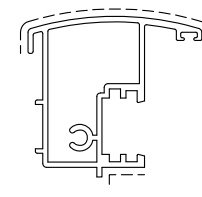

D3260023
Kg./m 0.815
sup.vista mm.72
TAPPO D4240078 DX
TAPPO D4240079 SX

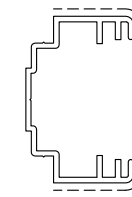

D3260054
Kg./m 0.505
sup.vista mm. 54

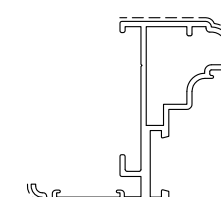

D3260260
kg/m. 0.884
sup. in vista mm.106

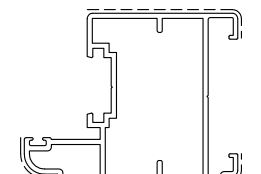

D3260261
kg/m. 0.928
sup. in vista mm. 116
TAPPO D4240153

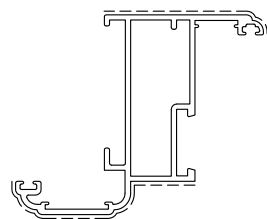

D3260255
kg/m. 0.884
sup. in vista mm. 106

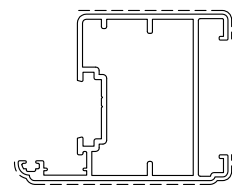

D3260257
kg/m. 0.856
sup. in vista mm. 110
TAPPO D4240152

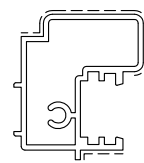

D3260259
kg/m. 0.690
sup. in vista mm. 68
TAPPO D4240146 DX
TAPPO D4240147 SX

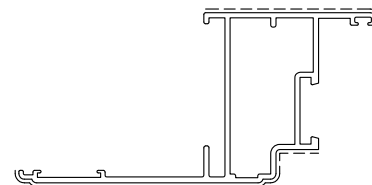

D3260264
kg/m. 0.946
sup. in vista mm. 139

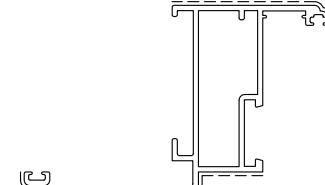

D3260256
kg/m. 0.953
sup. in vista mm. 122



D3260258
kg/m. 0.482
sup. in vista mm. -



D0050060
sup.vista mm. 0
Kg./m 0.219
CLIP L-ITEPFBA67

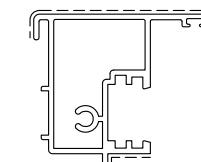

D3260265
kg/m. 0.773
sup. in vista mm. 69
TAPPO D4240150 DX
TAPPO D4240151 SX

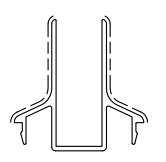

D3260267
kg/m. 0.395
sup. in vista mm. 67

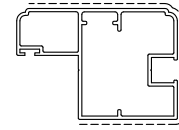

D3260201
sup.vista mm. 183
Kg./m 1.007
TAPPO D030D150

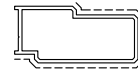

D3260202
sup.vista mm. 99
Kg./m 0.526
TAPPO D0030D90

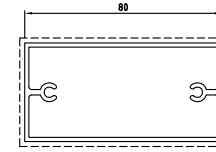

D3260226
sup.vista mm. 240
Kg./m 1.277

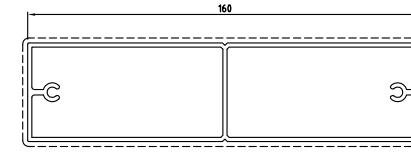

D3260227
sup.vista mm. 400
Kg./m 2.168

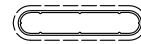

D0050013
sup.vista mm. 111
kg./m 0.240
TAPPO D4240018



D3280001
sup.vista mm. 0.347
Kg./m 111
TAPPO D4240018

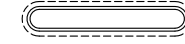

D3280002
sup.vista mm. 141
Kg./m 0.448
TAPPO D4240019

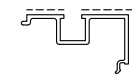

D3260212
sup.vista mm. 54
Kg./m 0.378



D0026187
sup.vista mm. 44
Kg./m 0.327



D3280006
sup.vista mm. 25
Kg./m 0.262

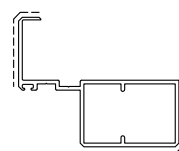

D3260234
sup.vista mm. 80
Kg./m 0.791

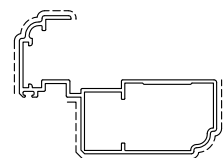

D3260172
sup.vista mm. 159
Kg./m 0.995

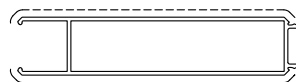

D3290130
sup.vista mm. 187
Kg./m 1.084



D1290003
sup.vista mm. 224
Kg./m 1.604

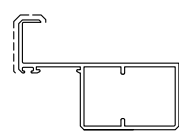

D3260235
sup.vista mm. 94
Kg./m 0.756

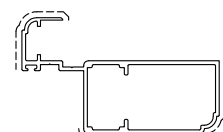

D3260044
sup.vista mm. 120
Kg./m 0.972

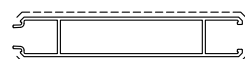

D3290131
sup.vista mm. 182
Kg./m 0.712

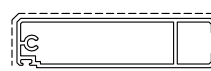

D3260244
sup.vista mm. 192
Kg./m 0.876

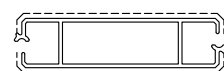

D3260245
sup.vista mm. 206
Kg./m 0.910

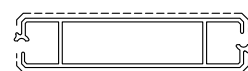

D3260246
sup.vista mm. 216
Kg./m 0.991

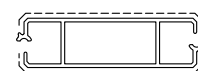

D3260247
sup.vista mm. 142
Kg./m 0.829



D3260238
sup.vista mm. =
Kg./m 0.724



D3260248
sup.vista mm. 113
Kg./m 0.527



D3290080
sup.vista mm. 248
Kg./m 0.937

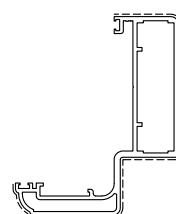

D3260268
sup.vista mm. 178
Kg./m 1.337



D3260243
sup.vista mm. 160
Kg./m 0.373
TAPPO 0030D89



D3260202
sup.vista mm. 99
Kg./m 0.526
TAPPO 0030D90



D3260237
sup.vista mm. 28
Kg./m 0.143

XU15452
Kg./m 0,383

D3260069
sup.vista mm. 79
Kg./m. 0.383

D3260076
sup.vista mm. 73
Kg./m. 0.618

XU20502
Kg./m 0,464

D3260070
sup.vista mm. 90
Kg./m. 0.464

D3260081
sup.vista mm. 106
Kg./m. 1.015

D3260088
sup.vista mm. 109
Kg./m. 1.040

D3260071
sup.vista mm. 121
Kg./m. 0.864
TAPPO D030D102

D3260072
sup.vista mm. 141
Kg./m. 0.940
TAPPO D030D103

D3260073
sup.vista mm. 161
Kg./m. 1.015
TAPPO D030D104

D3260086
sup.vista mm. 322
Kg./m. 1.904

D3260087
sup.vista mm. 485
Kg./m. 2.884

D3260082
sup.vista mm. 176
Kg./m. 0.972

D3260084
sup.vista mm. 356
Kg./m. 2.014

D3260089
sup.vista mm. 79
Kg./m. 0.618
TAPPO D030D101
TAPPO D030D106
TAPPO D030D107

D3260075
sup.vista mm. 73
Kg./m. 0.548
TAPPO D030D101
TAPPO D030D106
TAPPO D030D107

D3260074
sup.vista mm. 55
Kg./m. 0.343
TAPPO D030D100

D3260077
sup.vista mm. 51
Kg./m. 0.567

D3260080
sup.vista mm. 73
Kg./m. 0.556
TAPPO D030D101
TAPPO D030D106
TAPPO D030D107

D3260065
sup.vista mm. 64
Kg./m. 0.462

D3260064
sup.vista mm. 595
Kg./m. 3.375

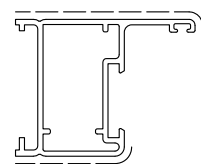

D0050100
kg/m. 0.664
Sup. in vista 82

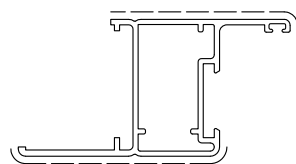

D0050101
kg/m. 0.778
Sup. in vista 109

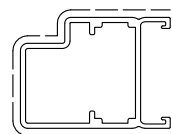

D0050104
kg/m. 0.564
Sup. in vista 115

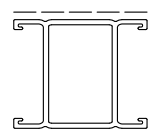

D0050105
kg/m. 0.481
Sup. in vista 74
TAPPO D00AW508

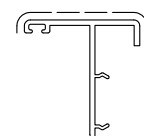

D0050110
kg/m. 0.292
Sup. in vista 49

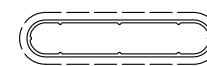

D0050013
kg/m. 0.240
Sup. in vista 111

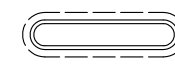

D0050114
kg/m. 0.232
Sup. in vista 89

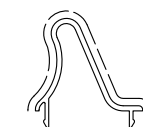

D0050115
kg/m. 0.267
Sup. in vista 65

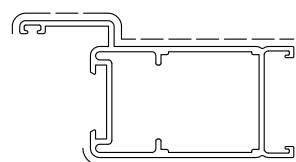

D0050102
kg/m. 0.853
Sup. in vista 179
TAPPO D00AW504

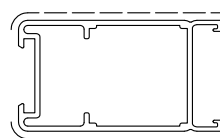

D0050103
kg/m. 0.716
Sup. in vista 118
TAPPO D00AW504



D0050108
kg/m. 0.354
Sup. in vista 17

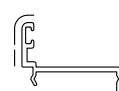

D0050109
kg/m. 0.170
Sup. in vista 14

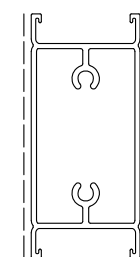

D0050106
kg/m. 0.875
Sup. in vista 134
TAPPO D00AW515 (SPORTELLO)
TAPPO D00AW507 (FISSO)

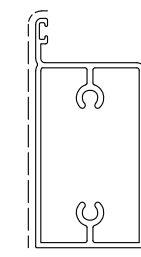

D0050107
kg/m. 0.797
Sup. in vista 114
TAPPO D00AW515 (SPORTELLO)
TAPPO D00AW507 (FISSO)



D3290130
kg/m. 1.084
Sup. in vista 218



D3210017
kg/m. 0.119
Sup. in vista 31



D3210008
kg/m. 0.055
Sup. in vista 16



D0050118
kg/m. 0.454
Sup. in vista /



D3290001
kg/m. 0.144
Sup. in vista 14



D3290080
kg/m. 0.975
Sup. in vista 247



D0050060
sup.vista mm. 0
Kg./m 0.219
CLIP L-ITEPFBA67

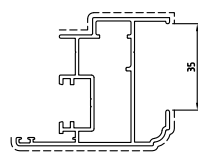

D0027539
sup.vista mm. 132
Kg./m 1.002
TAPPO D0030D85

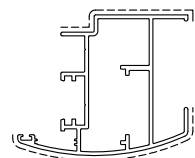

D0060908
sup.vista mm. 139
Kg./m 1.183
TAPPO D4B40001

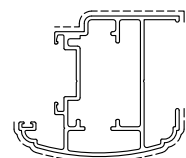

D0060390
sup.vista mm. 145
Kg./m 1.234
TAPPO L-ITLP124

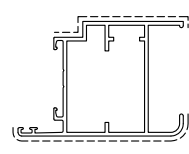

D3260239
sup.vista mm. 355
Kg./m 0.975
TAPPO L-ITES1898

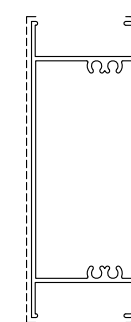

D3260229
sup.vista mm. 255
Kg./m 1.674
TAPPO L-ITES1896

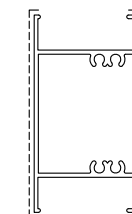

D3260230
sup.vista mm. 175
Kg./m 1.307
TAPPO L-ITES1896

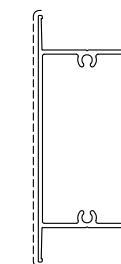

D3220061
sup.vista mm. 207
Kg./m 1.310

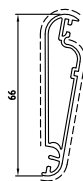

D0007432
sup.vista mm. 134
Kg./m 0.537

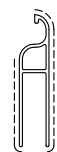

D0007507
sup.vista mm. 115
Kg./m 0.383

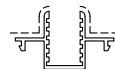

D0007434
sup.vista mm. 45
Kg./m 0.365



D0183513
sup.vista mm. 34
Kg./m 0.195

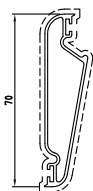

D0007475
sup.vista mm. 129
Kg./m 0.529



D3021002
sup.vista mm. 123
Kg./m 0.450



D3021003
sup.vista mm. 22
Kg./m 0.311

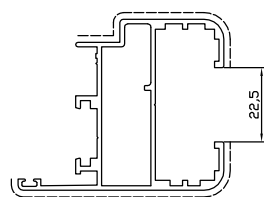

D0027492
sup.vista mm. 140
Kg./m 1.088

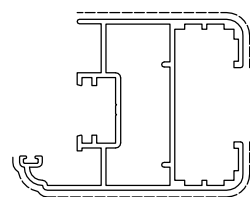

D0060104
sup.vista mm. 148
Kg./m 1.245

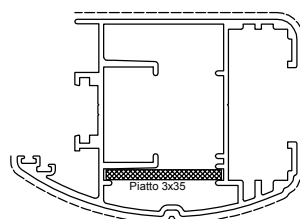

D0060059
sup.vista mm. 188
Kg./m 1.758
TAPPO DX D4B20001
TAPPO SX D4B20002

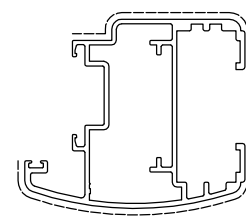

D3B60000
sup.vista mm. 158
Kg./m 1.326

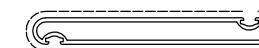

D3032000
sup.vista mm. 148
Kg./m 0.506



D0008209
sup.vista mm. 152
Kg./m 0.527

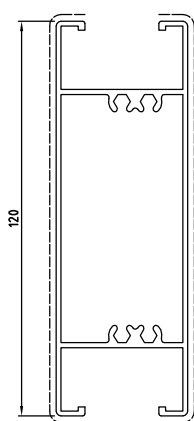

D0027493
sup.vista mm. 275
Kg./m 1.700
TAPPO L-ITES1430

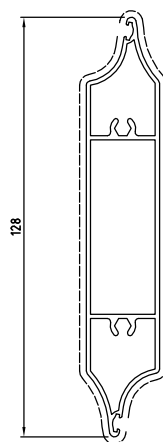

D0027494
sup.vista mm. 259
Kg./m 1.173

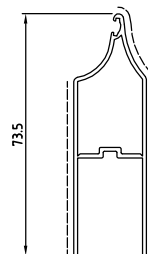

D0007437
sup.vista mm. 152
Kg./m 0.527



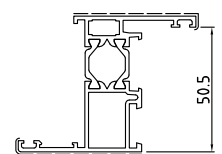
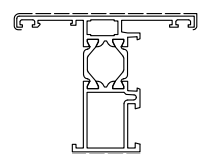
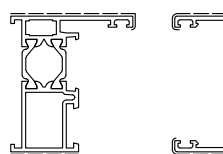
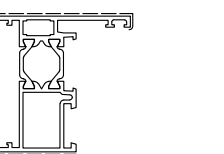
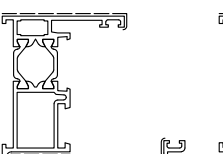
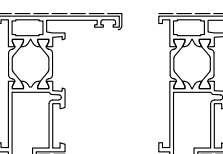
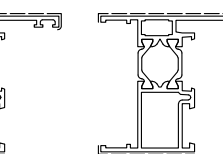
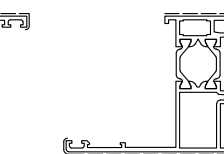
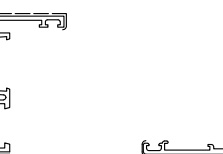
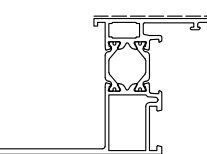

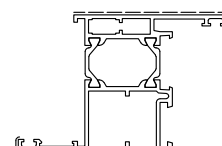
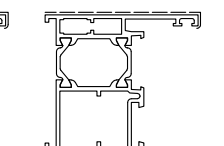
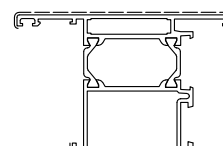
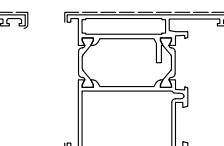
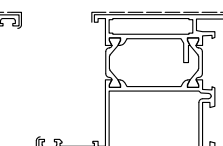
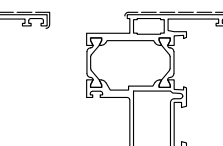
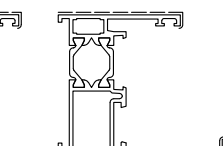
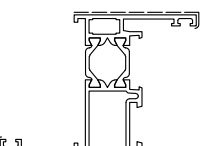
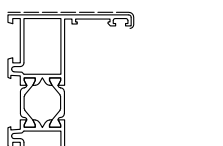
Nuovi profili Maggio 2019

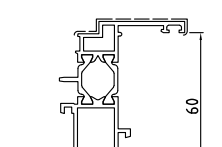
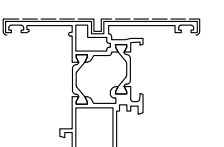
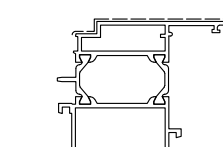
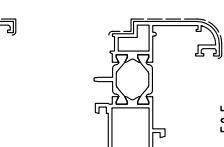
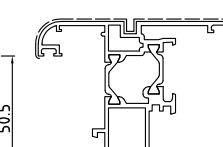
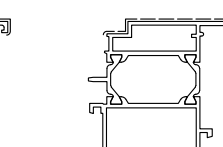
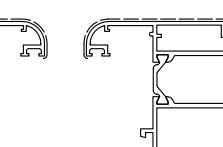
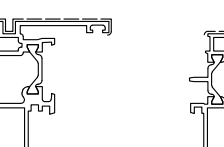
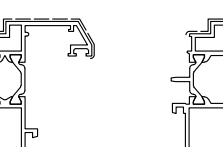
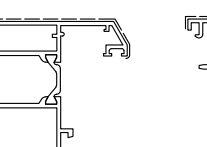
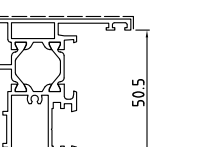
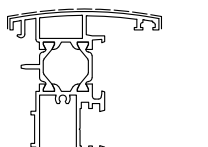
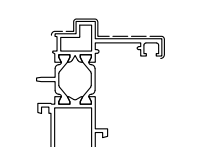
 D1210350 Kg/m 1.238 Sup. in vista mm 109	 D1210351 Kg/m 1.238 Sup. in vista mm 110	 D1210352 Kg/m 1.104 Sup. in vista mm 82	 D1210353 Kg/m 1.372 Sup. in vista mm 137	 D1210354 Kg/m 1.277 Sup. in vista mm 116	 D1210355 Kg/m 1.397 Sup. in vista mm 122	 D1210357 Kg/m 1.198 Sup. in vista mm 89	 D1210360 Kg/m 1.205 Sup. in vista mm 108	 D1210361 Kg/m 1.324 Sup. in vista mm 126	 D1061009 Kg/m 1.523 Sup. in vista mm 155
---	--	---	--	---	--	---	--	--	--

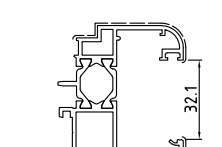
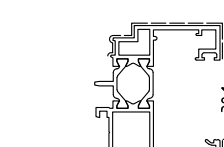
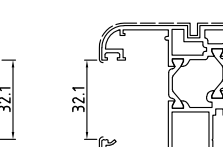
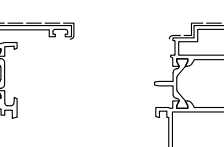
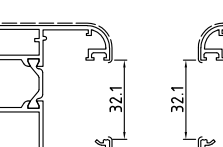
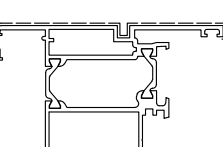
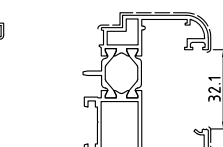
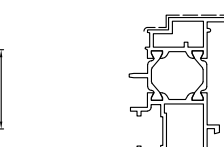
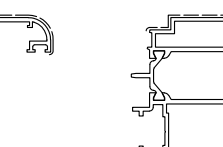
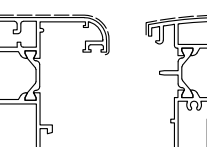
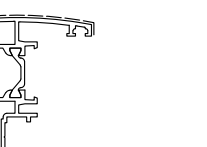
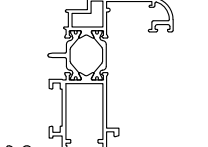
 D1210384 Kg/m 1.487 Sup. in vista mm 134	 D1210385 Kg/m 1.353 Sup. in vista mm 107	 D1210363 Kg/m 1.619 Sup. in vista mm 154	 D1210364 Kg/m 1.524 Sup. in vista mm 131	 D1210365 Kg/m 1.658 Sup. in vista mm 154	 D1210376 Kg/m 1.367 Sup. in vista mm 76	 D1210386 Kg/m 1.21 Sup. in vista mm 89	 D1210387 Kg/m 1.456 Sup. in vista mm 129	 D1210476 Kg/m 1.39 Sup. in vista mm 109
---	--	--	--	---	---	--	--	---

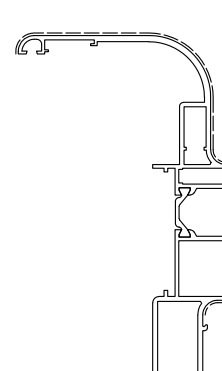
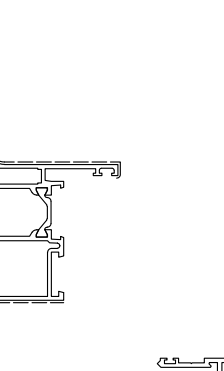
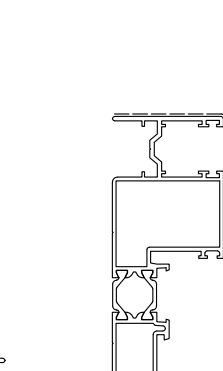
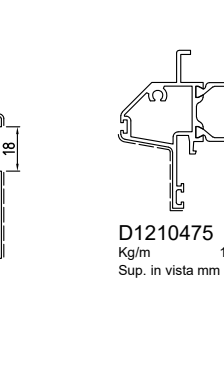
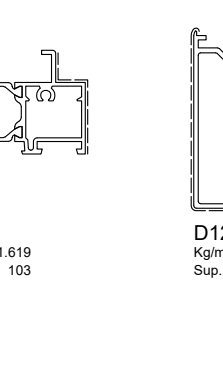
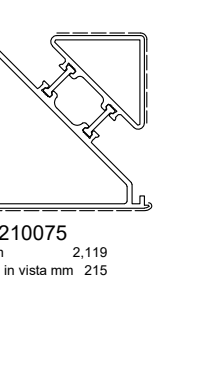
 D1210401 Kg/m 1.276 Sup. in vista mm 103	 D1210402 Kg/m 1.577 Sup. in vista mm 139 TAPPO EST. D4240305 TAPPO INT. D4240304	 D1210403 Kg/m 1.701 Sup. in vista mm 146	 D1210404 Kg/m 1.342 Sup. in vista mm 109	 D1210405 Kg/m 1.641 Sup. in vista mm 145 TAPPO EST. D4240305 TAPPO INT. D4240304	 D1210406 Kg/m 1.763 Sup. in vista mm 151	 D1210407 Kg/m 2.059 Sup. in vista mm 188 TAPPO EST. D4240305 TAPPO INT. D4240304	 D1210408 Kg/m 1.34 Sup. in vista mm 108	 D1210409 Kg/m 1.763 Sup. in vista mm 151	 D1210410 Kg/m 1.395 Sup. in vista mm 85 TAPPO D4240306	 D1210411 Kg/m 1.448 Sup. in vista mm 87 TAPPO D4240307	 D1210422 Kg/m 1.298 Sup. in vista mm 112	 D1061012 Kg/m 1.599 Sup. in vista mm 147 TAPPO EST. D4240305 TAPPO INT. D4240304
---	--	--	--	---	--	--	---	--	---	---	--	--

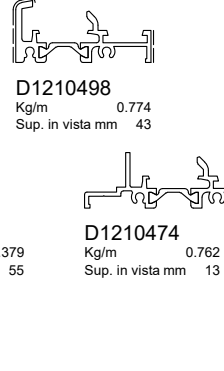
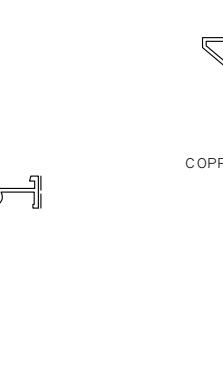
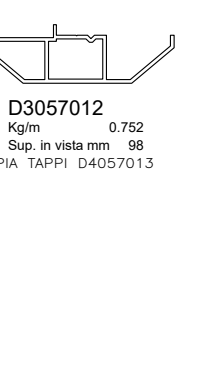
 D1210412 Kg/m 1.498 Sup. in vista mm 146	 D1210421 Kg/m 1.535 Sup. in vista mm 160	 D1210413 Kg/m 1.797 Sup. in vista mm 183	 D1210414 Kg/m 1.92 Sup. in vista mm 189	 D1210415 Kg/m 2.215 Sup. in vista mm 226	 D1210418 Kg/m 1.557 Sup. in vista mm 148	 D1210429 Kg/m 1.556 Sup. in vista mm 124	 D1210430 Kg/m 1.976 Sup. in vista mm 167	 D1210431 Kg/m 1.398 Sup. in vista mm 85 TAPPO D4240308	 D1061013 Kg/m 1.583 Sup. in vista mm 117	 D1210477 Kg/m 1.491 Sup. in vista mm 67	 D3210020 Kg/m 0.503 Sup. in vista mm 41
---	--	--	---	---	--	--	--	---	--	---	---

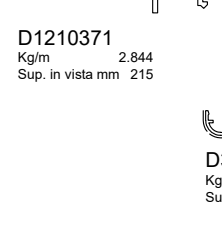
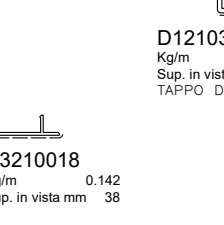
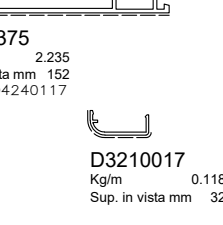
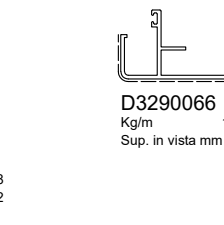
 D1210371 Kg/m 2.844 Sup. in vista mm 215	 D1210375 Kg/m 2.235 Sup. in vista mm 152 TAPPO D4240117	 D1210475 Kg/m 1.619 Sup. in vista mm 103	 D1210075 Kg/m 2.119 Sup. in vista mm 215	 D3210016 Kg/m 0.379 Sup. in vista mm 55	 D1210474 Kg/m 0.762 Sup. in vista mm 13	 D1210498 Kg/m 0.774 Sup. in vista mm 43	 D3057012 Kg/m 0.752 Sup. in vista mm 98 COPPIA TAPPI D4057013	 D3091045 Kg/m 0.206 Sup. in vista mm 24 TAPPO SX D4040029 TAPPO DX D4040030	 D3290136 Kg/m 0.184 Sup. in vista mm 33	 D3290137 Kg/m 0.178 Sup. in vista mm 31	 D3290001 Kg/m 0.144 Sup. in vista mm 14
 D3210018 Kg/m 0.142 Sup. in vista mm 38	 D3210017 Kg/m 0.118 Sup. in vista mm 32	 D3290066 Kg/m 1.290 Sup. in vista mm 222	 D3220113 Kg/m 0.699 Sup. in vista mm 79								

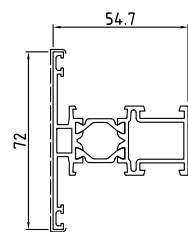

D1210451
Kg/m 1.309
Sup. in vista mm 109

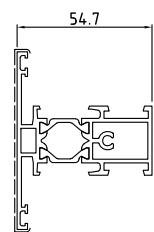

D1210452
Kg/m 1.377
Sup. in vista mm 109

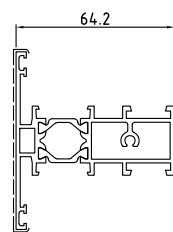

D1210453
Kg/m 1.473
Sup. in vista mm 109

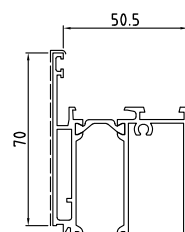

D1210459
Kg/m 1.858
Sup. in vista mm 144

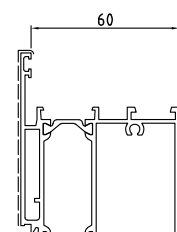

D1210457
Kg/m 1.941
Sup. in vista mm 144

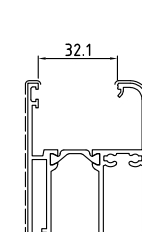

D1210455
Kg/m 1.634
Sup. in vista mm 153

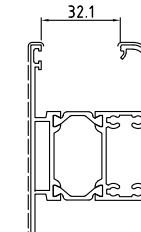

D1210458
Kg/m 1.859
Sup. in vista mm 207

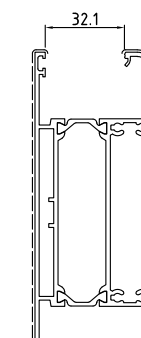

D1210456
Kg/m 2.644
Sup. in vista mm 287

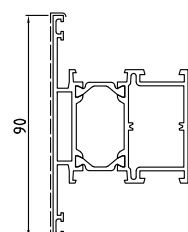

D1210462
Kg/m 1.675
Sup. in vista mm 145

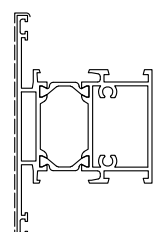

D1210463
Kg/m 1.749
Sup. in vista mm 145

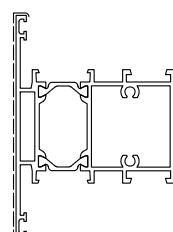

D1210454
Kg/m 1.837
Sup. in vista mm 145

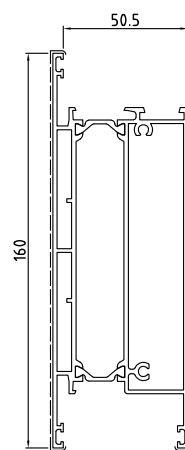

D1210468
Kg/m 3.219
Sup. in vista mm 311

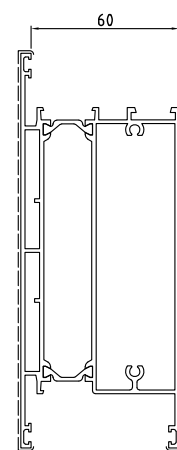

D1210469
Kg/m 3.309
Sup. in vista mm 311

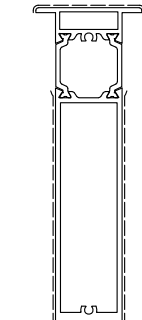

D1211027
Kg/m 2.06
Sup. in vista mm 261

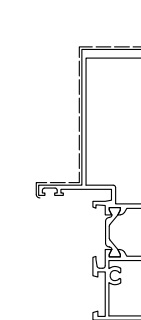

D1210470
Kg/m 2.62
Sup. in vista mm 255

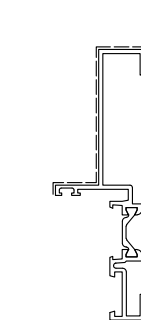

D1210471
Kg/m 1.928
Sup. in vista mm 141

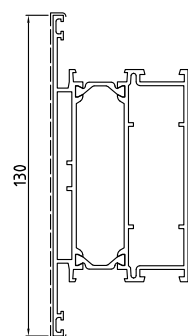

D1210464
Kg/m 2.459
Sup. in vista mm 225

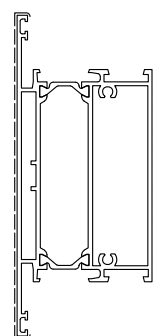

D1210465
Kg/m 2.521
Sup. in vista mm 225

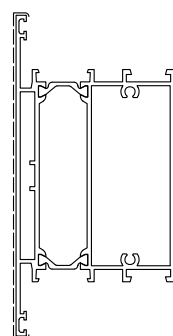

D1210460
Kg/m 2.609
Sup. in vista mm 225

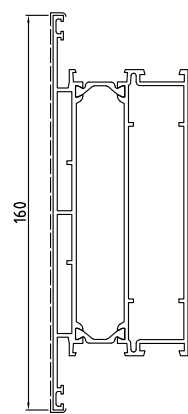

D1210466
Kg/m 3.05
Sup. in vista mm 285

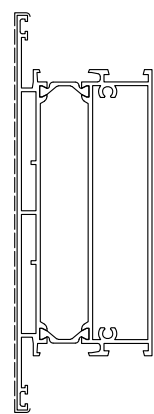

D1210467
Kg/m 3.112
Sup. in vista mm 285

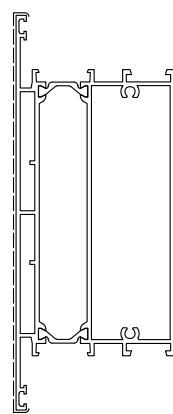

D1210461
Kg/m 3.2
Sup. in vista mm 285

Profili per ristrutturazione su telai in legno



W4000187
Profilo prefornato

D3076021
Kg/m 0.176
Sup. in vista mm ---

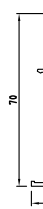

W4000185

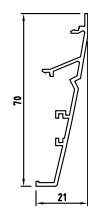

W4000185

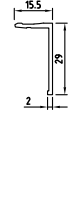

W3090136

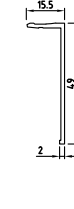

W3090137

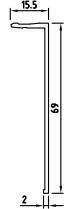

W3090121

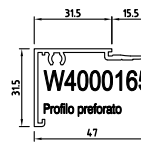

W3090122

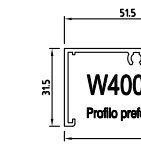

W3090221

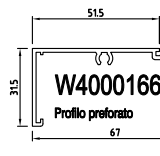

W4000165
Profilo prefornato

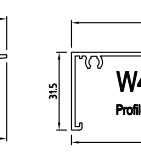

W4000166
Profilo prefornato

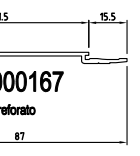

W4000167
Profilo prefornato

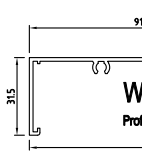

W4000168
Profilo prefornato

Alette di battuta riportate

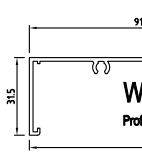
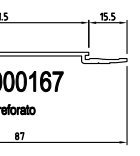
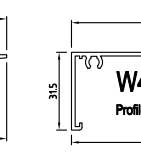
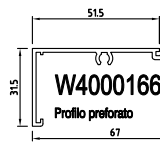
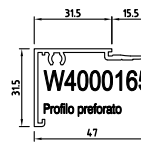
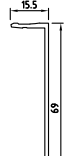
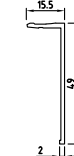
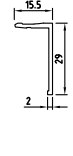

Coprifilo per soglia avanzata

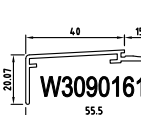

W3090161

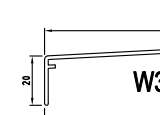

W3090162

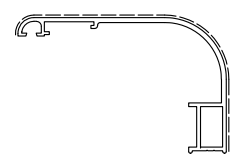

D3220109
Kg/m 0.876
Sup. in vista mm 132

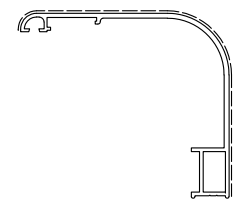

D3220110
Kg/m 0.984
Sup. in vista mm 152

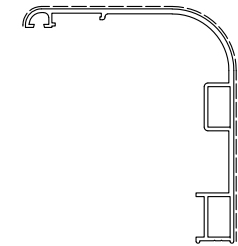

D3220111
Kg/m 1.215
Sup. in vista mm 172

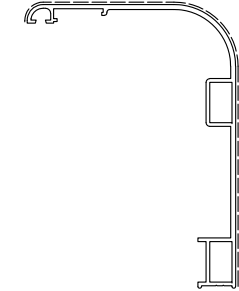

D3220112
Kg/m 1.323
Sup. in vista mm 192

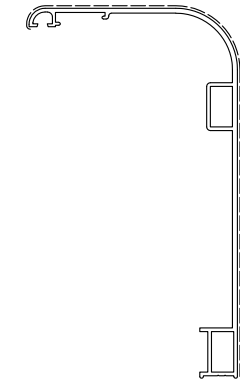

D3220141
Kg/m 1.538
Sup. in vista mm 536

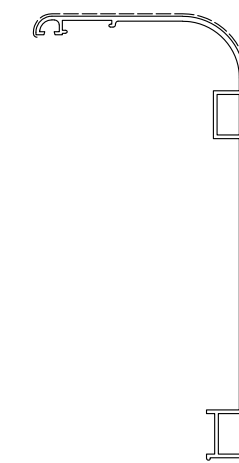

D0034761
Kg/m 1.703
Sup. in vista mm 597

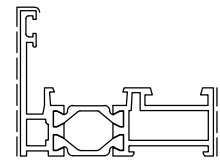

D1061000
Kg/m 0.98
Sup. in vista mm 66

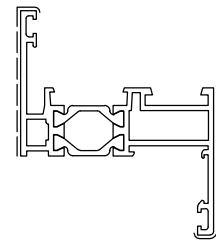

D1061001
Kg/m 1.108
Sup. in vista mm 93

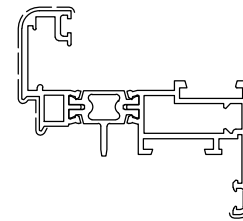

D1061002
Kg/m 1.168
Sup. in vista mm 97

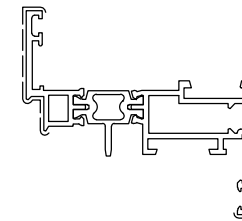

D1061004
Kg/m 1.088
Sup. in vista mm 88

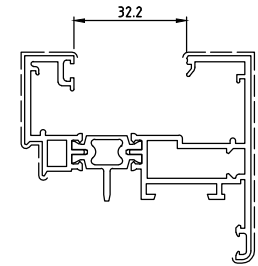

D1061006
Kg/m 1.344
Sup. in vista mm 135

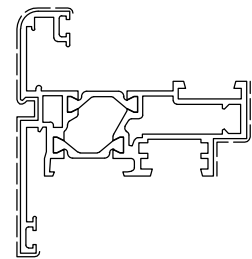

D1061003
Kg/m 1.516
Sup. in vista mm 133

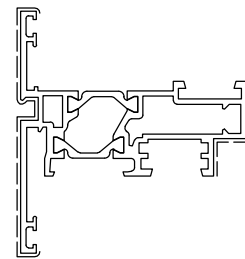

D1061005
Kg/m 1.436
Sup. in vista mm 126

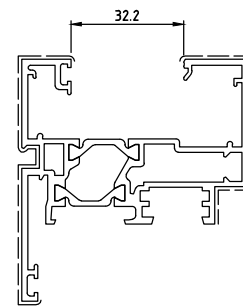

D1061007
Kg/m 1.692
Sup. in vista mm 174

 D1210750 Kg/m 1.331 Sup. in vista mm 109	 D1210751 Kg/m 1.331 Sup. in vista mm 110	 D1210752 Kg/m 1.197 Sup. in vista mm 82	 D1210753 Kg/m 1.448 Sup. in vista mm 161	 D1210754 Kg/m 1.370 Sup. in vista mm 116	 D1210755 Kg/m 1.489 Sup. in vista mm 122	 D1210757 Kg/m 1.290 Sup. in vista mm 89	 D1210760 Kg/m 1.281 Sup. in vista mm 131	 D1210761 Kg/m 1.417 Sup. in vista mm 126	 D1210766 Kg/m 1.615 Sup. in vista mm 155 Fori asole e squadrette (int/est) da fare con pantografo.	 D1210780 Kg/m 1.484 Sup. in vista mm 113	 D1210781 Kg/m 1.350 Sup. in vista mm 86	 D1210782 Kg/m 1.484 Sup. in vista mm 113	 D1210779 Kg/m 1.57 Sup. in vista mm 131	 D1210783 Kg/m 1.350 Sup. in vista mm 87
 D1210784 Kg/m 1.603 Sup. in vista mm 134	 D1210785 Kg/m 1.470 Sup. in vista mm 107	 D1210763 Kg/m 1.735 Sup. in vista mm 154	 D1210764 Kg/m 1.641 Sup. in vista mm 131	 D1210765 Kg/m 1.774 Sup. in vista mm 154	 D1210777 Kg/m 1.561 Sup. in vista mm 93	 D1210788 Kg/m 1.419 Sup. in vista mm 124	 D1210789 Kg/m 1.285 Sup. in vista mm 97	 D1210762 Kg/m 1.263 Sup. in vista mm 82	 D1210776 Kg/m 1.473 Sup. in vista mm 76	 D1210786 Kg/m 1.303 Sup. in vista mm 89	 D1210787 Kg/m 1.549 Sup. in vista mm 129	 D1210876 Kg/m 1.473 Sup. in vista mm 109		
 D1210801 Kg/m 1.366 Sup. in vista mm 158	 D1210802 Kg/m 1.654 Sup. in vista mm 163 TAPPO EST. D4240303 TAPPO INT. D4240304	 D1210803 Kg/m 1.805 Sup. in vista mm 177	 D1210804 Kg/m 1.432 Sup. in vista mm 164	 D1210805 Kg/m 1.718 Sup. in vista mm 169 TAPPO EST. D4240303 TAPPO INT. D4240304	 D1210806 Kg/m 1.868 Sup. in vista mm 151	 D1210807 Kg/m 2.135 Sup. in vista mm 212 TAPPO EST. D4240303 TAPPO INT. D4240304	 D1210808 Kg/m 1.430 Sup. in vista mm 164	 D1210809 Kg/m 1.867 Sup. in vista mm 183	 D1210822 Kg/m 1.388 Sup. in vista mm 112	 D1210818 Kg/m 1.693 Sup. in vista mm 158	 D1210819 Kg/m 1.604 Sup. in vista mm 151	 D1210810 Kg/m 1.454 Sup. in vista mm 108 TAPPO D4240300	 D1210811 Kg/m 1.492 Sup. in vista mm 109 TAPPO D4240301	
 D1210812 Kg/m 1.627 Sup. in vista mm 211	 D1210813 Kg/m 1.915 Sup. in vista mm 216 TAPPO EST. D4240303 TAPPO INT. D4240304	 D1210814 Kg/m 2.065 Sup. in vista mm 198	 D1210815 Kg/m 2.332 Sup. in vista mm 258 TAPPO EST. D4240303 TAPPO INT. D4240304	 D1210828 Kg/m 1.582 Sup. in vista mm 118	 D1210829 Kg/m 1.646 Sup. in vista mm 179	 D1210830 Kg/m 2.080 Sup. in vista mm 198	 D1057043 Kg/m 2.018 Sup. in vista mm 161	 D1210816 Kg/m 1.866 Sup. in vista mm 171	 D1210817 Kg/m 2.300 Sup. in vista mm 213	 D1210831 Kg/m 1.458 Sup. in vista mm 108 TAPPO D4240302	 D1057047 Kg/m 1.422 Sup. in vista mm 84 TAPPO D4240302	 D1210820 Kg/m 1.152 Sup. in vista mm 87		
 D1210836 Kg/m 1.387 Sup. in vista mm 92	 D1210837 Kg/m 2.088 Sup. in vista mm 178	 D3210017 Kg/m 0.118 Sup. in vista mm 32	 D1210773 Kg/m 2.311 Sup. in vista mm 175 TAPPO D4240117	 D1210875 Kg/m 1.695 Sup. in vista mm 127	 D3210352 Kg/m 0.370 Sup. in vista mm --	 D1210075 Kg/m 2.119 Sup. in vista mm 215	 D1057057 Kg/m 1.672 Sup. in vista mm 117	 D1057056 Kg/m 1.676 Sup. in vista mm 117 TAPPO EST. D4240303 TAPPO INT. D4240304	 D3057012 Kg/m 0.752 Sup. in vista mm 98 COPPIA TAPPI D4057013	 D4057006 Kg/m 0.149 Sup. in vista mm -- TPE	 D3210016 Kg/m 0.379 Sup. in vista mm 55	 D1210874 Kg/m 0.797 Sup. in vista mm 13	 D1210898 Kg/m 0.809 Sup. in vista mm 43	
 D1210796 Kg/m 1.256 Sup. in vista mm 63	 D1210835 Kg/m 1.969 Sup. in vista mm 157	 D3290066 Kg/m 1.290 Sup. in vista mm 222	 D3290136 Kg/m 0.184 Sup. in vista mm 33	 D3290137 Kg/m 0.178 Sup. in vista mm 31	 D3290001 Kg/m 0.144 Sup. in vista mm 14	 D3057005 Kg/m 0.104 Sup. in vista mm 15	 D1210477 Kg/m 1.491 Sup. in vista mm 67	 D3210020 Kg/m 0.503 Sup. in vista mm 41	 D3220113 Kg/m 0.699 Sup. in vista mm 79	 D3091045 Kg/m 0.206 Sup. in vista mm 24 TAPPO SX D4040029 TAPPO DX D4040030	 D3220132 Kg/m 0.198 Sup. in vista mm --			

Nuovi profili Marzo 2021 telai con barrette piane

 D1057060 Kg/m 1.400 Sup. in vista mm 126	 D1057058 Kg/m 1.315 Sup. in vista mm 82	 D1057059 Kg/m 1.181 Sup. in vista mm 109
--	---	--

Data: 11/11/2021

Data: 14/01/2014 14:10

 D1210851 Kg/m 1.402 Sup. in vista mm 109	 D1210852 Kg/m 1.469 Sup. in vista mm 109	 D1210853 Kg/m 1.566 Sup. in vista mm 109	 D1210859 Kg/m 1.935 Sup. in vista mm 144	 D1210857 Kg/m 2.018 Sup. in vista mm 144	 D1210455 Kg/m 1.634 Sup. in vista mm 153	 D1210458 Kg/m 1.859 Sup. in vista mm 207	 D1061008 Kg/m 1.881 Sup. in vista mm 211	 D1210456 Kg/m 2.644 Sup. in vista mm 287	 D1210478 Kg/m 1.645 Sup. in vista mm 153	 D1210479 Kg/m 1.870 Sup. in vista mm 207				
 D1210862 Kg/m 1.792 Sup. in vista mm 145	 D1210863 Kg/m 1.865 Sup. in vista mm 145	 D1210854 Kg/m 1.953 Sup. in vista mm 145	 D1210868 Kg/m 3.295 Sup. in vista mm 311	 D1210869 Kg/m 3.392 Sup. in vista mm 311	Profili per ristrutturazione su telai in legno W4000187 Profilo prefornato			Alette di battuta riportate W3090136			 D3076021 Kg/m 0.176 Sup. in vista mm ---	 W3090121	 W3090122	 W3090221
 D1210864 Kg/m 2.551 Sup. in vista mm 225	 D1210865 Kg/m 2.613 Sup. in vista mm 225	 D1210860 Kg/m 2.702 Sup. in vista mm 225	 D1211027 Kg/m 2.060 Sup. in vista mm 261	 D1210870 Kg/m 2.736 Sup. in vista mm 255	 D1210871 Kg/m 2.016 Sup. in vista mm 141	 W4000204 Profilo prefornato	 W4000205 Profilo prefornato	 W4000165 Profilo prefornato	 W4000166 Profilo prefornato	 W4000167 Profilo prefornato	 W4000168 Profilo prefornato			
 D1210866 Kg/m 3.142 Sup. in vista mm 285	 D1210867 Kg/m 3.204 Sup. in vista mm 285	 D1210861 Kg/m 3.299 Sup. in vista mm 285	 D1210770 Kg/m 2.527 Sup. in vista mm 230	 D1210771 Kg/m 2.947 Sup. in vista mm 215	 D3210018 Kg/m 0.142 Sup. in vista mm 38	Coprifilo per soglia avanzata W3090161			 W3090162	 W4000185 Profilo prefornato, Tappo 4040455	 W4000186 Profilo prefornato, Tappo 4040456			
 D1210866 Kg/m 3.142 Sup. in vista mm 285	 D1210867 Kg/m 3.204 Sup. in vista mm 285	 D1210861 Kg/m 3.299 Sup. in vista mm 285	 D3220109 Kg/m 0.876 Sup. in vista mm 132	 D3220110 Kg/m 0.984 Sup. in vista mm 152	 D3220111 Kg/m 1.215 Sup. in vista mm 172	 D3220112 Kg/m 1.323 Sup. in vista mm 192	 D3220141 Kg/m 1.538 Sup. in vista mm 536	 D0034761 Kg/m 1.703 Sup. in vista mm 597						

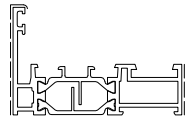

D1211280
Kg/m 1.057
Sup. in vista mm 66

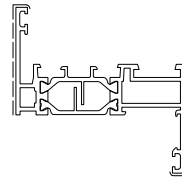

D1211281
Kg/m 1.184
Sup. in vista mm 93

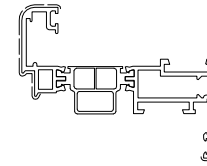

D1211282
Kg/m 1.211
Sup. in vista mm 97

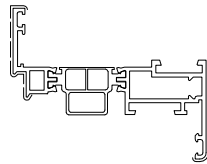

D1211284
Kg/m 1.130
Sup. in vista mm 89

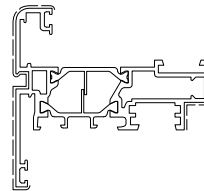

D1211283
Kg/m 1.593
Sup. in vista mm 133

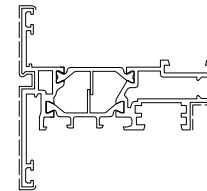

D1211285
Kg/m 1.512
Sup. in vista mm 126

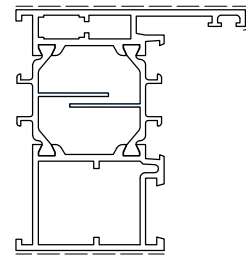

D1057000
Kg/m 1.470
Sup. in vista mm 107

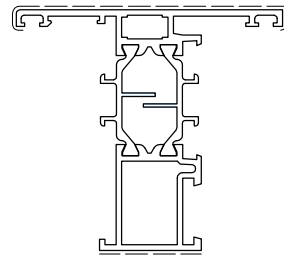

D1057001
Kg/m 1.331
Sup. in vista mm 110

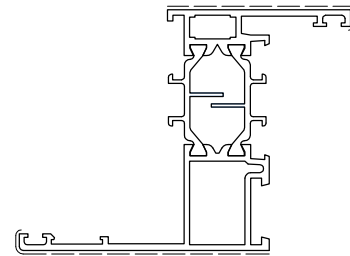

D1057002
Kg/m 1.417
Sup. in vista mm 126

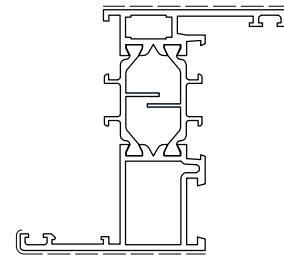

D1057003
Kg/m 1.331
Sup. in vista mm 109

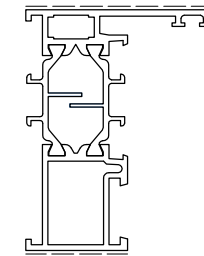

D1057004
Kg/m 1.197
Sup. in vista mm 82

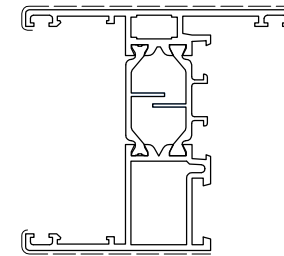

D1057005
Kg/m 1.448
Sup. in vista mm 161

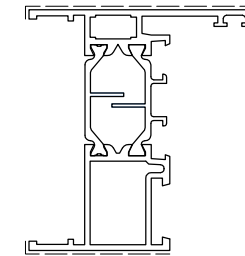

D1057006
Kg/m 1.281
Sup. in vista mm 131

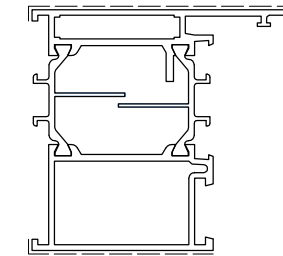

D1057007
Kg/m 1.641
Sup. in vista mm 131

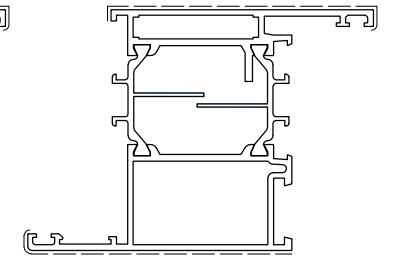

D1057008
Kg/m 1.774
Sup. in vista mm 154

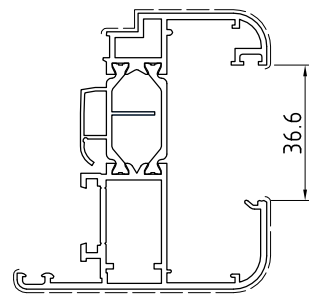

D1057009
Kg/m 1.594
Sup. in vista mm 151

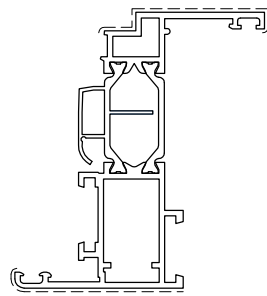

D1057010
Kg/m 1.356
Sup. in vista mm 158

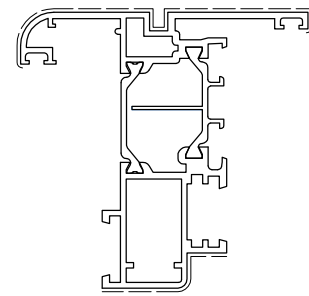

D1057011
Kg/m 1.719
Sup. in vista mm 169
TAPPO EST. D4240303
TAPPO INT. D4240304

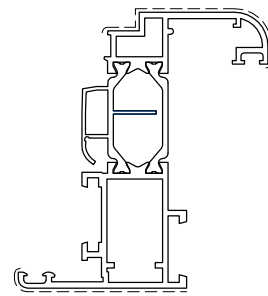

D1057012
Kg/m 1.422
Sup. in vista mm 164

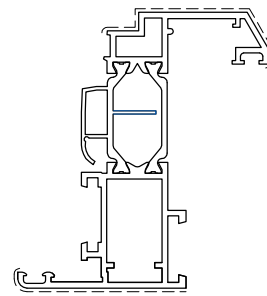

D1057013
Kg/m 1.419
Sup. in vista mm 164

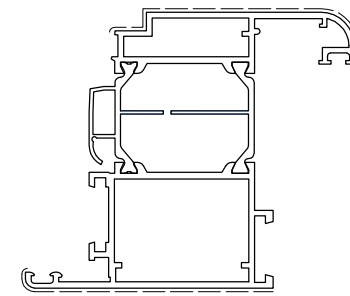

D1057014
Kg/m 1.868
Sup. in vista mm 183

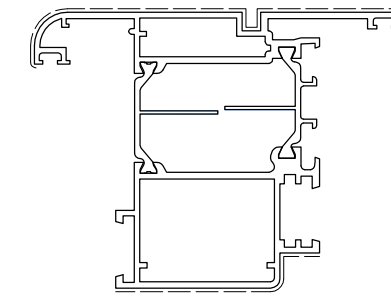

D1057015
Kg/m 2.161
Sup. in vista mm 212
TAPPO EST. D4240303
TAPPO INT. D4240304

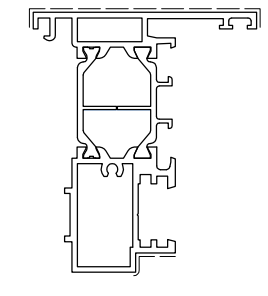

D1057016
Kg/m 1.454
Sup. in vista mm 108
TAPPO D4240300

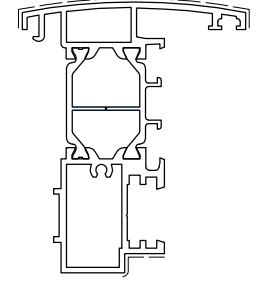

D1057017
Kg/m 1.492
Sup. in vista mm 109
TAPPO D4240301

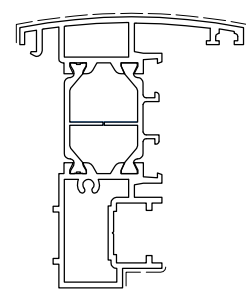

D1057021
Kg/m 1.458
Sup. in vista mm 108
TAPPO D4240302

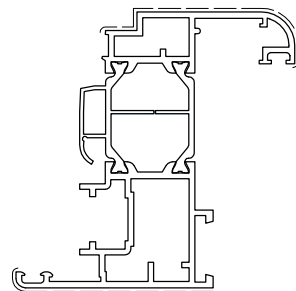

D1057022
Kg/m 1.646
Sup. in vista mm 179

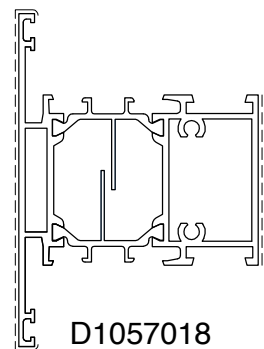

D1057018
Kg/m 1.865
Sup. in vista mm 145

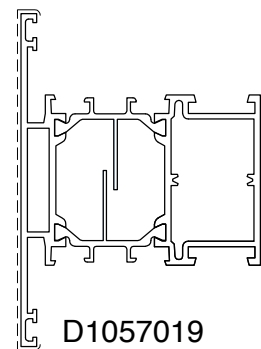

D1057019
Kg/m 1.792
Sup. in vista mm 145

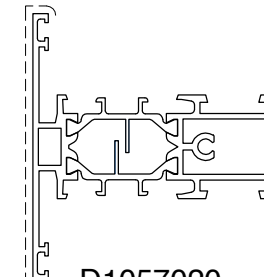

D1057020
Kg/m 1.469
Sup. in vista mm 109

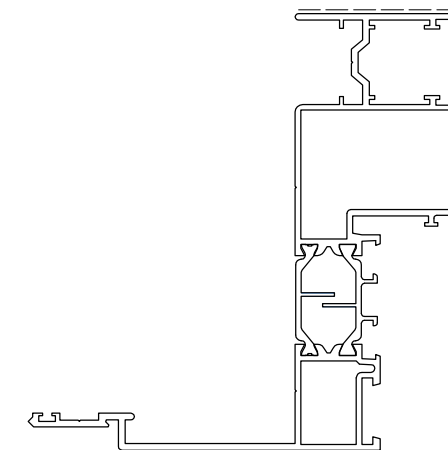

D1057023
Kg/m 2.311
Sup. in vista mm 175
TAPPO D4240117

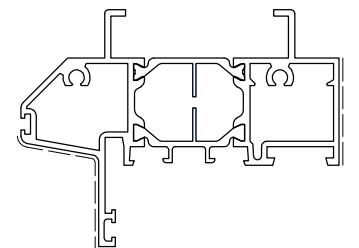

D1057041
Kg/m 1.695
Sup. in vista mm 103
TAPPO D4240117

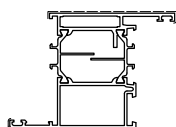

D1210765
Kg/m 1.774
Sup. in vista mm 154

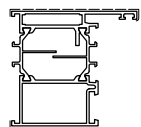

D1210764
Kg/m 1.641
Sup. in vista mm 131



D3290449
Kg/m 0.269
Sup. in vista mm 17

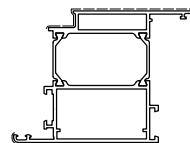

D1210880
Kg/m 2.224
Sup. in vista mm 186

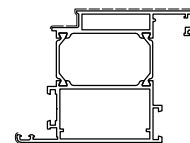

D1210882
Kg/m 2.311
Sup. in vista mm 192

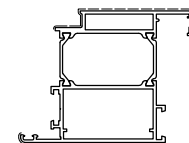

D1210884
Kg/m 2.304
Sup. in vista mm 191

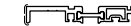

D1210472
Kg/m 0.692
Sup. in vista mm 20

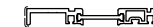

D1210872
Kg/m 0.721
Sup. in vista mm 20

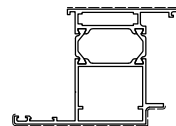

D1210900
Kg/m 1.835
Sup. in vista mm 169

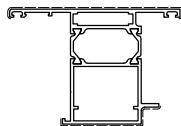

D1210905
Kg/m 1.835
Sup. in vista mm 169

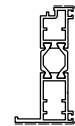

D1001001
Kg/m 0.988
Sup. in vista mm 44

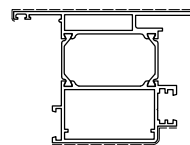

D1210881
Kg/m 2.455
Sup. in vista mm 202
TAPPO EST. D4240166
TAPPO INT. D4240304

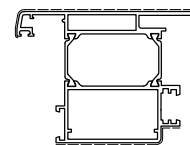

D1210883
Kg/m 2.542
Sup. in vista mm 210
TAPPO EST. D4240166
TAPPO INT. D4240304

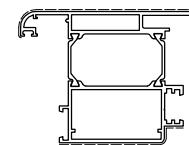

D1210885
Kg/m 2.534
Sup. in vista mm 208
TAPPO EST. D4240166
TAPPO INT. D4240304

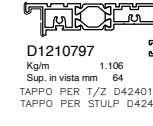

D1210797
Kg/m 1.106
Sup. in vista mm 64
TAPPO PER T/Z D4240173
TAPPO PER STULP D4240174



D1210798
Kg/m 0.982
Sup. in vista mm 92

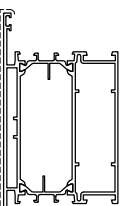

D1210864
Kg/m 2.551
Sup. in vista mm 225

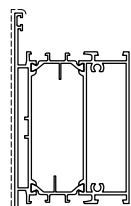

D1210865
Kg/m 2.613
Sup. in vista mm 225

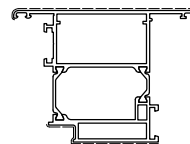

D1210886
Kg/m 2.305
Sup. in vista mm 181

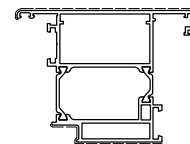

D1210888
Kg/m 2.390
Sup. in vista mm 193

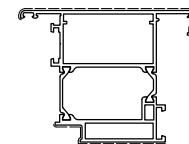

D1210890
Kg/m 2.383
Sup. in vista mm 191



D3290216
Kg/m 0.306
Sup. in vista mm --



D3200035
Kg/m 0.340
Sup. in vista mm --

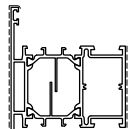

D1210862
Kg/m 1.792
Sup. in vista mm 145

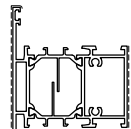

D1210863
Kg/m 1.865
Sup. in vista mm 145

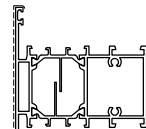

D1210854
Kg/m 1.967
Sup. in vista mm 145

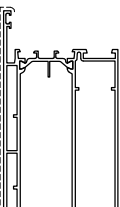

D1210866
Kg/m 3.142
Sup. in vista mm 285

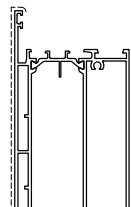

D1210867
Kg/m 3.204
Sup. in vista mm 285

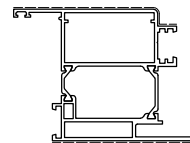

D1210887
Kg/m 2.536
Sup. in vista mm 198
TAPPO EST. D4240304
TAPPO INT. D4240166

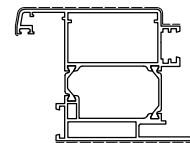

D1210889
Kg/m 2.621
Sup. in vista mm 210
TAPPO EST. D4240304
TAPPO INT. D4240166

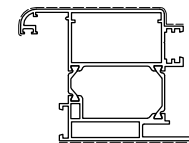

D1210891
Kg/m 2.614
Sup. in vista mm 208
TAPPO EST. D4240304
TAPPO INT. D4240166



D3290217
Kg/m 0.302
Sup. in vista mm 22
TAPPO D4240168



D3290218
Kg/m 0.442
Sup. in vista mm 34
TAPPO D4240168

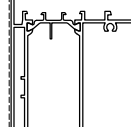

D1210860
Kg/m 2.702
Sup. in vista mm 225

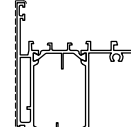

D1210857
Kg/m 2.018
Sup. in vista mm 168

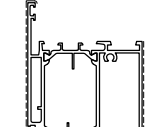

D1210859
Kg/m 1.935
Sup. in vista mm 168

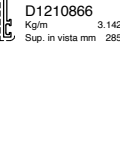

D1210868
Kg/m 3.295
Sup. in vista mm 335

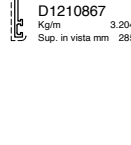

D1210870
Kg/m 2.736
Sup. in vista mm 255

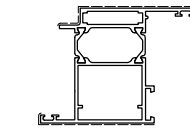

D1210901
Kg/m 1.803
Sup. in vista mm 159
TAPPO D4240266

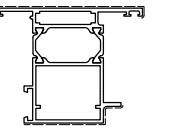

D1210902
Kg/m 1.853
Sup. in vista mm 163
TAPPO D4240266

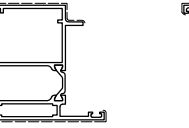

D1210903
Kg/m 2.049
Sup. in vista mm 177
TAPPO D4240266

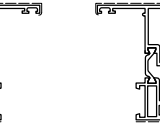

D1210904
Kg/m 2.004
Sup. in vista mm 102
TAPPO D4240266

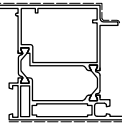

D1001000
Kg/m 2.045
Sup. in vista mm 164
TAPPO D4240266

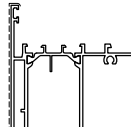

D1210861
Kg/m 3.293
Sup. in vista mm 285

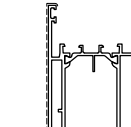

D1210869
Kg/m 3.385
Sup. in vista mm 335

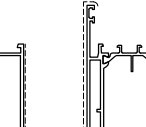

D1210868
Kg/m 3.295
Sup. in vista mm 335

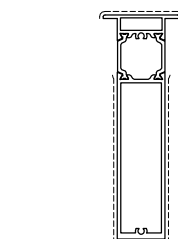

D1211027
Kg/m 2.060
Sup. in vista mm 261

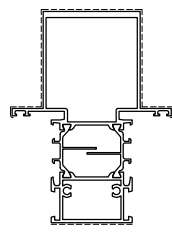

D1210871
Kg/m 2.030
Sup. in vista mm 141

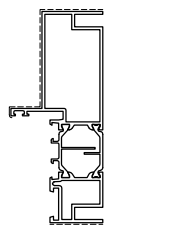

D1210892
Kg/m 1.532
Sup. in vista mm 89
TAPPO D4260167

D4240167

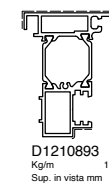

D1210893
Kg/m 1.478
Sup. in vista mm 78
TAPPO D4260167

D4240167

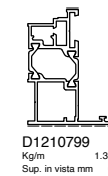

D1210799
Kg/m 1.336
Sup. in vista mm 62



D3091045
Kg/m 0.206
Sup. in vista mm 24
TAPPO SX D4040029
TAPPO DX D4040030



D3220128
Kg/m 0.494
Sup. in vista mm 87



D3220126
Kg/m 0.226
Sup. in vista mm 52

D1060000 Kg/m 1.384 Sup. in vista mm 109	D1060001 Kg/m 1.384 Sup. in vista mm 110	D1060002 Kg/m 1.25 Sup. in vista mm 82	D1060003 Kg/m 1.502 Sup. in vista mm 137	D1060004 Kg/m 1.423 Sup. in vista mm 116	D1060005 Kg/m 1.542 Sup. in vista mm 122	D1060006 Kg/m 1.343 Sup. in vista mm 89	D1060007 Kg/m 1.335 Sup. in vista mm 108	D1060008 Kg/m 1.47 Sup. in vista mm 126	D1060067 Kg/m 1.699 Sup. in vista mm 155	D1060016 Kg/m 1.537 Sup. in vista mm 113	D1060017 Kg/m 1.403 Sup. in vista mm 86	D1060018 Kg/m 1.537 Sup. in vista mm 113	D1060019 Kg/m 1.403 Sup. in vista mm 87	D1060009 Kg/m 1.316 Sup. in vista mm 82

Nuovi profili Maggio 2019

D1060071 Kg/m 1.368 Sup. in vista mm 109	D1060072 Kg/m 1.234 Sup. in vista mm 82	D1060020 Kg/m 1.657 Sup. in vista mm 134	D1060021 Kg/m 1.523 Sup. in vista mm 107	D1060010 Kg/m 1.789 Sup. in vista mm 154	D1060011 Kg/m 1.694 Sup. in vista mm 131	D1060012 Kg/m 1.827 Sup. in vista mm 154	D1060015 Kg/m 1.55 Sup. in vista mm 76	D1060022 Kg/m 1.356 Sup. in vista mm 89	D1060023 Kg/m 1.602 Sup. in vista mm 129	D1060061 Kg/m 1.52 Sup. in vista mm 109

D1060025 Kg/m 1.431 Sup. in vista mm 103	D1060026 Kg/m 1.707 Sup. in vista mm 139 TAPPO EST. D4060006 TAPPO INT. D4240304	D1060027 Kg/m 1.881 Sup. in vista mm 146	D1060028 Kg/m 1.498 Sup. in vista mm 108	D1060029 Kg/m 1.771 Sup. in vista mm 145 TAPPO EST. D4060006 TAPPO INT. D4240304	D1060030 Kg/m 1.943 Sup. in vista mm 151	D1060031 Kg/m 2.218 Sup. in vista mm 188 TAPPO EST. D4060006 TAPPO INT. D4240304	D1060032 Kg/m 1.495 Sup. in vista mm 108	D1060033 Kg/m 1.943 Sup. in vista mm 151	D1060034 Kg/m 1.508 Sup. in vista mm 85 TAPPO D4060005	D1060035 Kg/m 1.546 Sup. in vista mm 85 TAPPO D4060005	D1060068 Kg/m 1.453 Sup. in vista mm 112	D1210477 Kg/m 1.491 Sup. in vista mm 67	D3210020 Kg/m 0.503 Sup. in vista mm 41

D1060036 Kg/m 1.582 Sup. in vista mm 118	D1060037 Kg/m 1.718 Sup. in vista mm 124	D1060038 Kg/m 2.156 Sup. in vista mm 167	D1060039 Kg/m 1.511 Sup. in vista mm 85 TAPPO D4060007	D1060103 Kg/m 1.473 Sup. in vista mm 85 TAPPO D4060007	D1060024 Kg/m 1.333 Sup. in vista mm 63	D1060066 Kg/m 1.405 Sup. in vista mm 62	D1060040 Kg/m 2.068 Sup. in vista mm 157	D1060062 Kg/m 1.412 Sup. in vista mm 92	D1060063 Kg/m 2.195 Sup. in vista mm 178	D1060102 Kg/m 1.738 Sup. in vista mm 117	D1060101 Kg/m 1.729 Sup. in vista mm 147 TAPPO EST. D4060006 TAPPO INT. D4240304

D1060013 Kg/m 3.003 Sup. in vista mm 215	D3210017 Kg/m 0.118 Sup. in vista mm 32	D1060060 Kg/m 1.749 Sup. in vista mm 103	D1060065 Kg/m 2.28 Sup. in vista mm 235	D3057012 Kg/m 0.752 Sup. in vista mm 98 COPPIA TAPPI D4057013	D3210016 Kg/m 0.379 Sup. in vista mm 55	D1060059 Kg/m 0.828 Sup. in vista mm 13	D1060069 Kg/m 0.84 Sup. in vista mm 42

D3210018 Kg/m 0.142 Sup. in vista mm 38	D1060014 Kg/m 2.365 Sup. in vista mm 152 TAPPO D4240117	D3290066 Kg/m 1.290 Sup. in vista mm 222	D3220113 Kg/m 0.699 Sup. in vista mm 79	D3076021 Kg/m 0.176 Sup. in vista mm ---	D3091045 Kg/m 0.206 Sup. in vista mm 24 TAPPO SX D4040029 TAPPO DX D4040030	D3290136 Kg/m 0.184 Sup. in vista mm 33	D3290137 Kg/m 0.178 Sup. in vista mm 31	D3290001 Kg/m 0.144 Sup. in vista mm 14

1 4 2 3 4 5 6 7 8 9 10 11 12 13 14 15 16 17 18 19 20 21 22 23 24 25 26 27 28 29 30 31 32 33 34 35 36 37 38 39 40 41 42 43 44 45 46 47 48 49 50 51 52 53 54 55 56 57 58 59 60 61 62 63 64 65 66 67 68 69 70 71 72 73 74 75 76 77 78 79 80 81 82 83 84 85 86 87 88 89 90 91 92 93 94 95 96 97 98 99 100

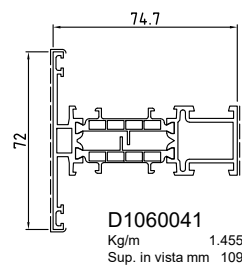

D1060041
Kg/m 1.455
Sup. in vista mm 109

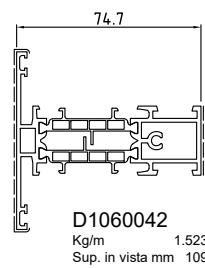

D1060042
Kg/m 1.523
Sup. in vista mm 109

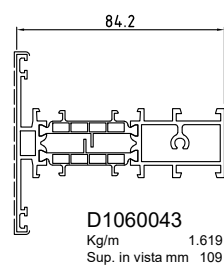

D1060043
Kg/m 1.619
Sup. in vista mm 109

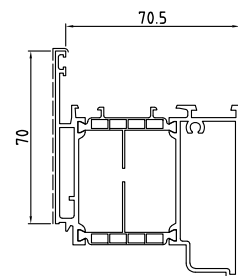

D1060046
Kg/m 1.935
Sup. in vista mm 144

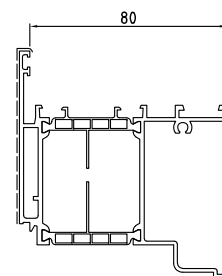

D1060045
Kg/m 2.101
Sup. in vista mm 144

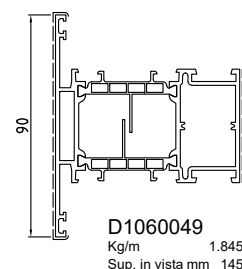

D1060049
Kg/m 1.845
Sup. in vista mm 145

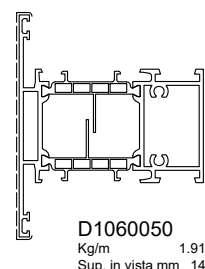

D1060050
Kg/m 1.918
Sup. in vista mm 145

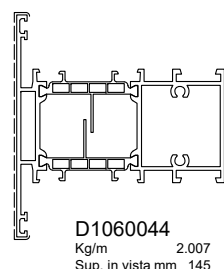

D1060044
Kg/m 2.007
Sup. in vista mm 145

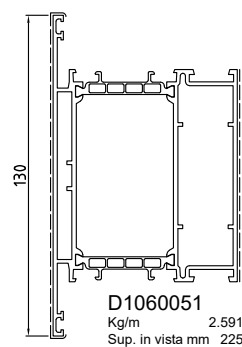

D1060051
Kg/m 2.591
Sup. in vista mm 225

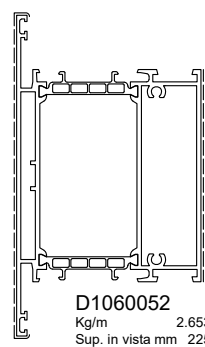

D1060052
Kg/m 2.653
Sup. in vista mm 225

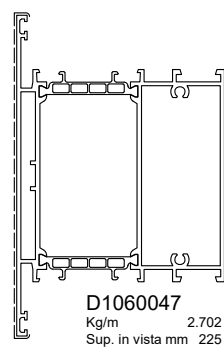

D1060047
Kg/m 2.702
Sup. in vista mm 225

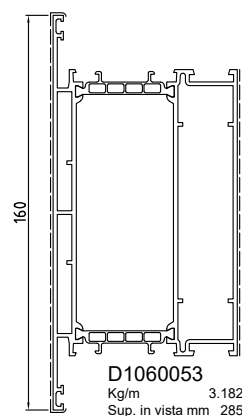

D1060053
Kg/m 3.182
Sup. in vista mm 285

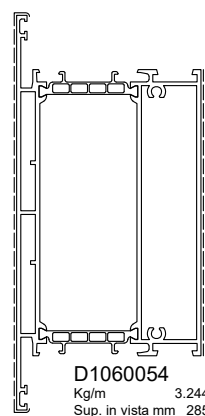

D1060054
Kg/m 3.244
Sup. in vista mm 285

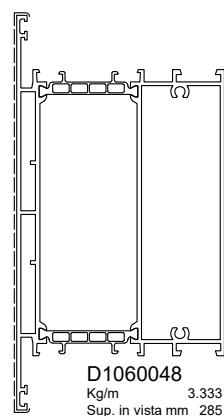

D1060048
Kg/m 3.333
Sup. in vista mm 285

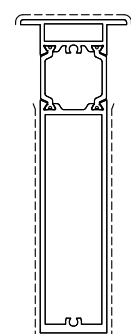

D1211027
Kg/m 2.060
Sup. in vista mm 261

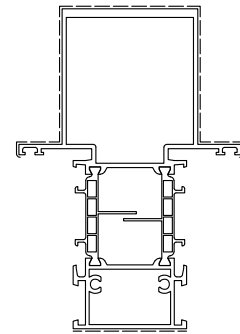

D1060057
Kg/m 2.789
Sup. in vista mm 255

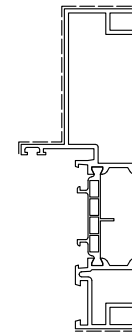

D1060058
Kg/m 2.051
Sup. in vista mm 141

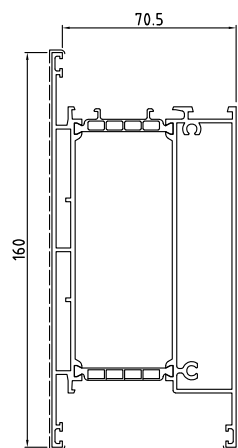

D1060055
Kg/m 3.336
Sup. in vista mm 311

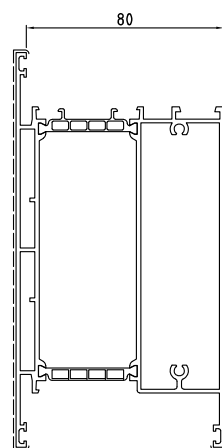

D1060056
Kg/m 3.425
Sup. in vista mm 311

Profili per ristrutturazione su telai in legno



W4000187
Profilo preforato

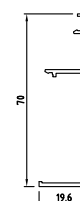

W3090136



W3090137



D3076021
Kg/m 0.176
Sup. in vista mm ---

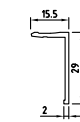

W3090121

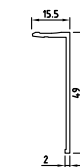

W3090122

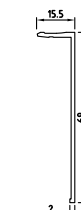

W3090221

Alette di battuta riportate

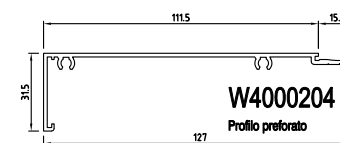

W4000204
Profilo preforato

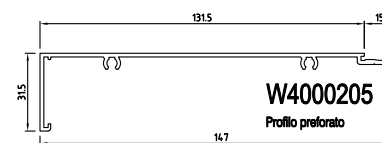

W4000205
Profilo preforato

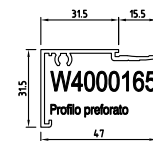

W4000165
Profilo preforato



W4000166
Profilo preforato

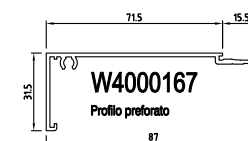

W4000167
Profilo preforato

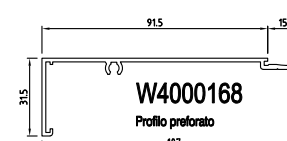

W4000168
Profilo preforato

Coprifilo per soglia avanzale

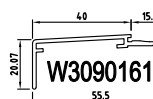

W3090161

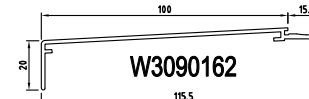

W3090162

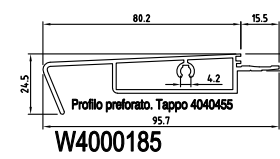

W4000185

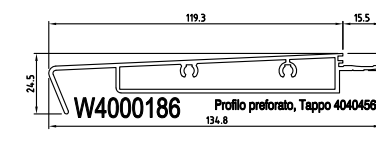

W4000186

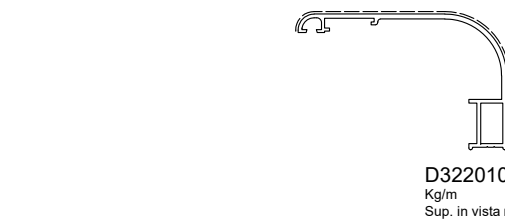

D3220109
Kg/m 0.876
Sup. in vista mm 132

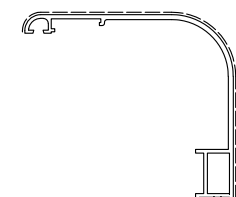

D3220110
Kg/m 0.984
Sup. in vista mm 152

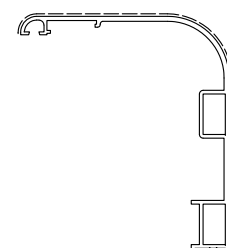

D3220111
Kg/m 1.215
Sup. in vista mm 172

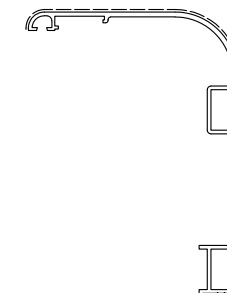

D3220112
Kg/m 1.323
Sup. in vista mm 192

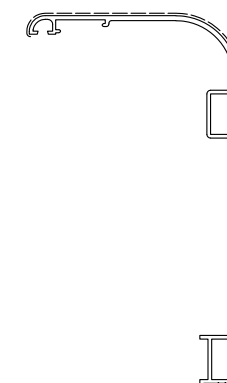

D3220141
Kg/m 1.538
Sup. in vista mm 536



D0034761
Kg/m 1.703
Sup. in vista mm 597

1 2 3 4 5 6 7 8 9 10 11 12 13 14 15 16 17 18 19 20 21 22 23 24 25 26 27 28 29 30 31 32 33 34 35 36 37 38 39 40 41 42 43 44 45 46 47 48 49 50 51 52 53 54 55 56 57 58 59 60 61 62 63 64 65 66 67 68 69 70 71 72 73 74 75 76 77 78 79 80 81 82 83 84 85 86 87 88 89 90 91 92 93 94 95 96 97 98 99 100

Tabellone 1-1

 D1060012 Kg/m 1.827 Sup. in vista mm 154	 D1060011 Kg/m 1.694 Sup. in vista mm 131	 D1060073 Kg/m 1.924 Sup. in vista mm 169	 D1060074 Kg/m 1.924 Sup. in vista mm 169	 D1060075 Kg/m 2.334 Sup. in vista mm 186	 D1060076 Kg/m 2.421 Sup. in vista mm 192	 D1060077 Kg/m 2.414 Sup. in vista mm 191	 D1060078 Kg/m 2.565 Sup. in vista mm 202	 D1060079 Kg/m 2.652 Sup. in vista mm 210	 D1060080 Kg/m 2.645 Sup. in vista mm 208
 D1060049 Kg/m 1.845 Sup. in vista mm 145	 D1060050 Kg/m 1.918 Sup. in vista mm 145	 D1060044 Kg/m 2.007 Sup. in vista mm 145		 D1060081 Kg/m 2.405 Sup. in vista mm 181	 D1060082 Kg/m 2.490 Sup. in vista mm 193	 D1060083 Kg/m 2.483 Sup. in vista mm 191	 D1060084 Kg/m 2.636 Sup. in vista mm 198 TAPPO EST. D4240304 TAPPO INT. D4240166	 D1060085 Kg/m 2.721 Sup. in vista mm 210 TAPPO EST. D4240304 TAPPO INT. D4240166	 D1060086 Kg/m 2.713 Sup. in vista mm 208 TAPPO EST. D4240304 TAPPO INT. D4240166
 D1060051 Kg/m 2.591 Sup. in vista mm 225	 D1060052 Kg/m 2.653 Sup. in vista mm 225	 D1060047 Kg/m 2.702 Sup. in vista mm 225	 D1060046 Kg/m 1.935 Sup. in vista mm 144	 D1060045 Kg/m 2.101 Sup. in vista mm 144	 D1060087 Kg/m 1.896 Sup. in vista mm 159 TAPPO D4240266	 D1060088 Kg/m 1.942 Sup. in vista mm 163 TAPPO D4240266	 D1060089 Kg/m 2.154 Sup. in vista mm 175 TAPPO D4240266	 D1060090 Kg/m 2.109 Sup. in vista mm 172 TAPPO D4240266	 D1060091 Kg/m 2.134 Sup. in vista mm 164 TAPPO D4240266
 D1060053 Kg/m 3.182 Sup. in vista mm 285	 D1060054 Kg/m 3.244 Sup. in vista mm 285	 D1060048 Kg/m 3.333 Sup. in vista mm 285	 D1060055 Kg/m 3.336 Sup. in vista mm 311	 D1060056 Kg/m 3.425 Sup. in vista mm 311	 D1060092 Kg/m 1.601 Sup. in vista mm 89 TAPPO D4060010	 D1060093 Kg/m 1.547 Sup. in vista mm 80 TAPPO D4060010	 D1060095 Kg/m 0.720 Sup. in vista mm 20	 D1060096 Kg/m 0.763 Sup. in vista mm 20	 D1060097 Kg/m 1.167 Sup. in vista mm 64 TAPPO D4060011 TAPPO D4060012
 D1211027 Kg/m 2.060 Sup. in vista mm 261	 D1060057 Kg/m 2.789 Sup. in vista mm 255	 D1060058 Kg/m 2.051 Sup. in vista mm 141	 D1060099 Kg/m 0.663 Sup. in vista mm 76	 D1060094 Kg/m 1.022 Sup. in vista mm 45	 D3220126 Kg/m 0.226 Sup. in vista mm ---	 D3290216 Kg/m 0.306 Sup. in vista mm ---	 D3200035 Kg/m 0.340 Sup. in vista mm ---	 D3290217 Kg/m 0.302 Sup. in vista mm 22 TAPPO D4240168	 D3290218 Kg/m 0.422 Sup. in vista mm 34 TAPPO D4240168
					 D3290449 Kg/m 0.269 Sup. in vista mm 17	 D3091045 Kg/m 0.206 Sup. in vista mm 24 TAPPO SX D4040029 TAPPO DX D4040030	 D3290001 Kg/m 0.144 Sup. in vista mm 14		

Data: LUGLIO 2018

Domal TOP TB55

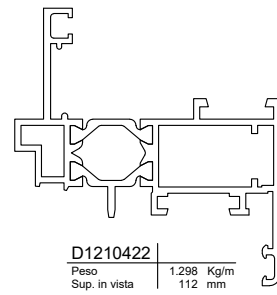

Domal TOP TB65

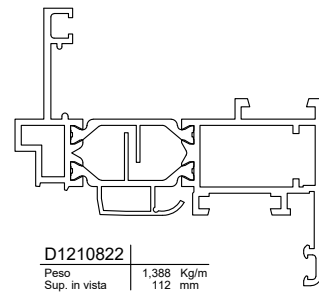

Domal TOP TB75

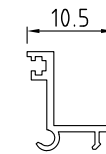
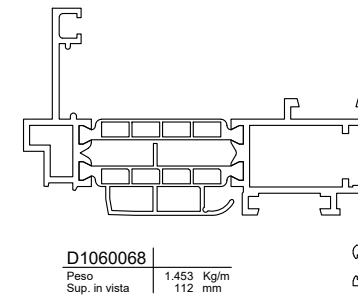

D3076019	
Peso	0.229 Kg/m
Sup. in vista	41 mm

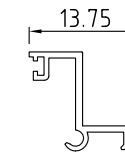
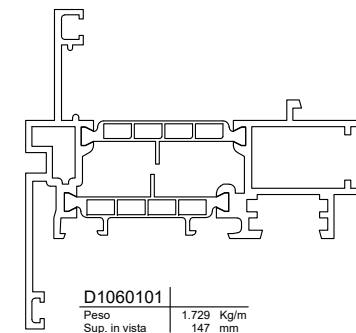
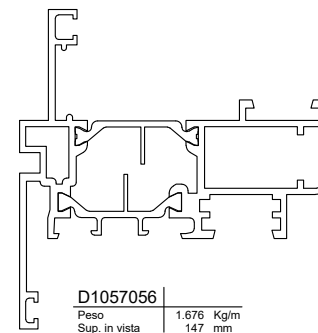
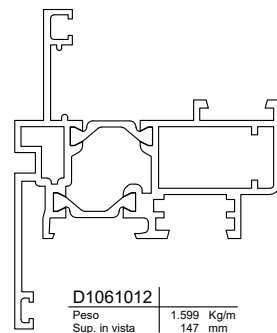

D3076020	
Peso	0.261 Kg/m
Sup. in vista	47 mm

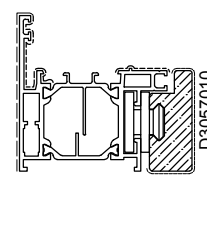

D1057044
Kg/m 1.355
Sup. in vista mm 67

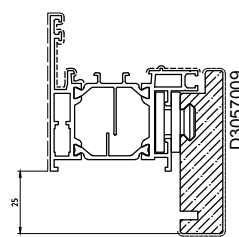

D1057044
Kg/m 1.355
Sup. in vista mm 67

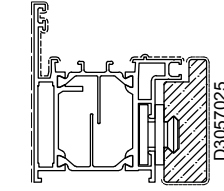

D1057053
Kg/m 1.564
Sup. in vista mm 76

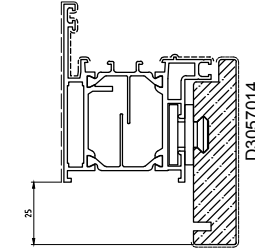

D1057053
Kg/m 1.564
Sup. in vista mm 76

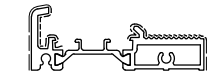

D1057052
Kg/m 0.966
Sup. in vista mm 42

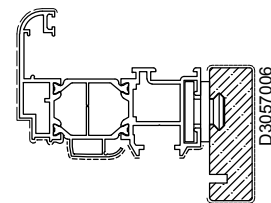

D1057045
Kg/m 1.533
Sup. in vista mm 67

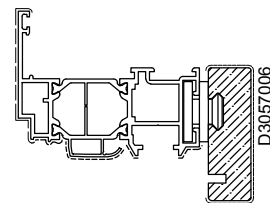

D1057046
Kg/m 1.469
Sup. in vista mm 62

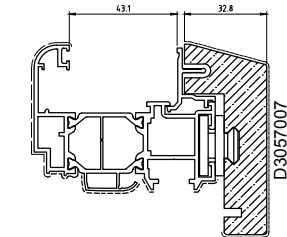

D1057045
Kg/m 1.533
Sup. in vista mm 67

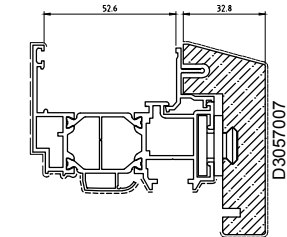

D1057046
Kg/m 1.469
Sup. in vista mm 62

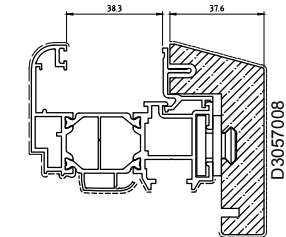

D1057045
Kg/m 1.533
Sup. in vista mm 67

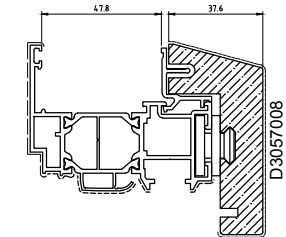

D1057046
Kg/m 1.469
Sup. in vista mm 62

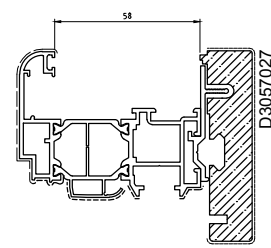

D1057045
Kg/m 1.533
Sup. in vista mm 67

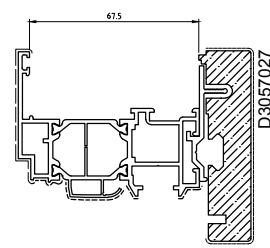

D1057046
Kg/m 1.469
Sup. in vista mm 62

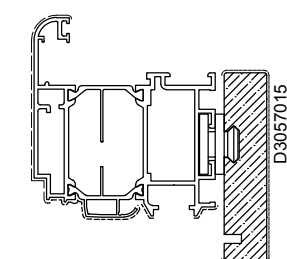

D1057050
Kg/m 2.064
Sup. in vista mm 89

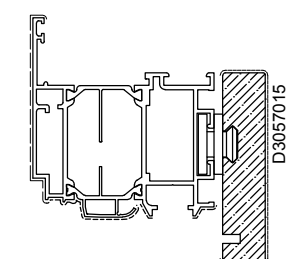

D1057051
Kg/m 2.002
Sup. in vista mm 83

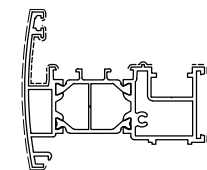

D1057048
Kg/m 1.484
Sup. in vista mm 77
TAPPO D4057014

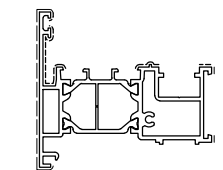

D1057049
Kg/m 1.448
Sup. in vista mm 77
TAPPO D4057014

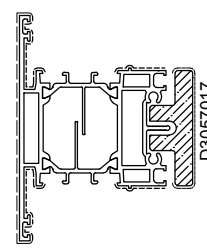

D1057054
Kg/m 1.861
Sup. in vista mm 99

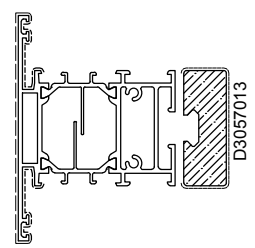

D1057055
Kg/m 1.884
Sup. in vista mm 99



D3290205
Kg/m 0.282
Sup. in vista mm --



D3290204
Kg/m 0.255
Sup. in vista mm --



D3290179
Kg/m 0.211
Sup. in vista mm --



D3290201
Kg/m 0.173
Sup. in vista mm --



D3290209
Kg/m 0.214
Sup. in vista mm --



D3290206
Kg/m 0.231
Sup. in vista mm --



D3290203
Kg/m 0.25
Sup. in vista mm --



D3057016
Kg/m 0.305
Sup. in vista mm --



D3057026
Kg/m 0.298
Sup. in vista mm --
IN BARRE



D4057017
ACCESSORIO

Legni

TELAJ

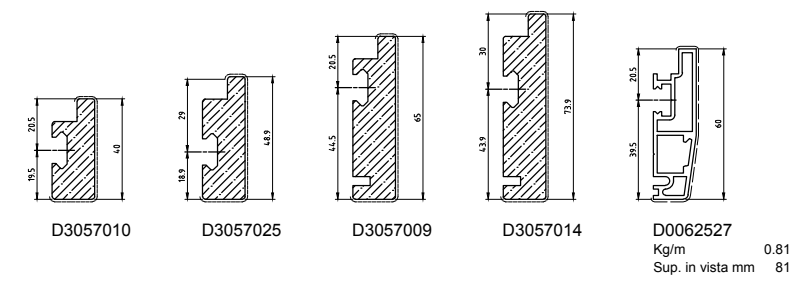

ANTE

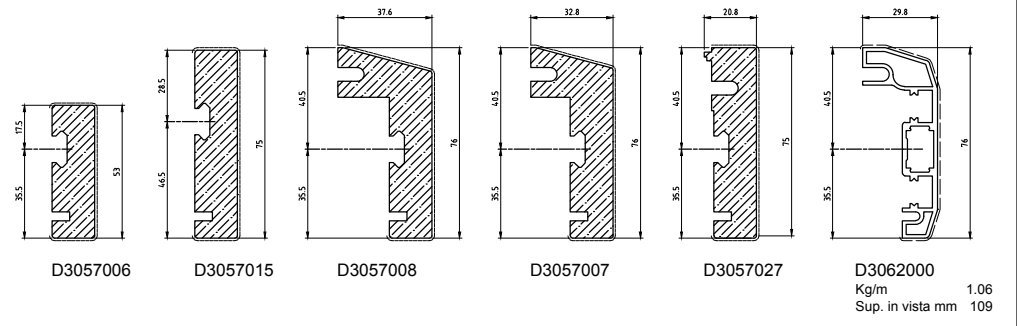

TRAVERSI

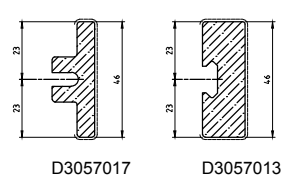

FERMAVETRI

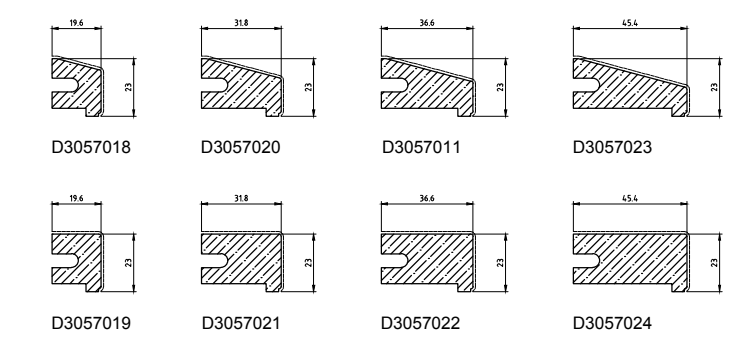

D3290129 Kg/m sup. in vista mm.	0.409 74						D3290122 Kg/m sup. in vista mm.
D3290099 Kg/m sup. in vista mm.	0.383 67.5						D3290121 Kg/m sup. in vista mm.
D0024315 Kg/m sup. in vista mm.	0.359 62						D3290052 Kg/m sup. in vista mm.
D3290023 Kg/m sup. in vista mm.	0.345 58.5						D3290120 Kg/m sup. in vista mm.
D3290026 Kg/m sup. in vista mm.	0.332 55	● D3290033 Kg/m sup. in vista mm.	0.293 55	D3290034 Kg/m sup. in vista mm.	0.322 55	D3290047 Kg/m sup. in vista mm.	D3290092 Kg/m sup. in vista mm.
D3290021 Kg/m sup. in vista mm.	0.319 51.5	● D3290035 Kg/m sup. in vista mm.	0.279 49	D3290040 Kg/m sup. in vista mm.	0.308 49	D3290050 Kg/m sup. in vista mm.	D3290119 Kg/m sup. in vista mm.
D3290025 Kg/m sup. in vista mm.	0.301 47.5	● D3290224 Kg/m sup. in vista mm.	0.263 45	D3290030 Kg/m sup. in vista mm.	0.293 45	D3290045 Kg/m sup. in vista mm.	D3290118 Kg/m sup. in vista mm.
D3290024 Kg/m sup. in vista mm.	0.289 44.5	● D3290036 Kg/m sup. in vista mm.	0.251 42	D3290038 Kg/m sup. in vista mm.	0.279 42	D3290043 Kg/m sup. in vista mm.	D3290117 Kg/m sup. in vista mm.
D3290020 Kg/m sup. in vista mm.	0.259 41	● D3290028 Kg/m sup. in vista mm.	0.238 38	D3290037 Kg/m sup. in vista mm.	0.250 38	D3290042 Kg/m sup. in vista mm.	D3290116 Kg/m sup. in vista mm.
D3290019 Kg/m sup. in vista mm.	0.248 37.5	● D3290032 Kg/m sup. in vista mm.	0.222 35	D3290031 Kg/m sup. in vista mm.	0.239 35	D3290041 Kg/m sup. in vista mm.	D3290115 Kg/m sup. in vista mm.
D3290018 Kg/m sup. in vista mm.	0.240 34	● D3290029 Kg/m sup. in vista mm.	0.208 31	D3290039 Kg/m sup. in vista mm.	0.230 34	D3290048 Kg/m sup. in vista mm.	D3290051 Kg/m sup. in vista mm.
D3290017 Kg/m sup. in vista mm.	0.231 30.5	● D3290014 Kg/m sup. in vista mm.	0.194 31	D3290049 Kg/m sup. in vista mm.	0.221 28		D3290114 Kg/m sup. in vista mm.
D3290027 Kg/m sup. in vista mm.	0.219 27						
D3290022 Kg/m sup. in vista mm.	0.181 23.5						

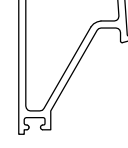
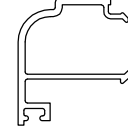
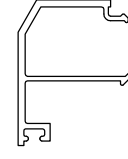
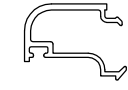
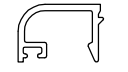
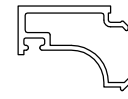

● CLIPS IN PLASTICA D4240039 (UTILIZZARE SOLO SU UNO DEI

NB: PER L'UTILIZZO DEI FERMAVETRI CONSULTARE IL RELATIVO MANUALE DOMAL

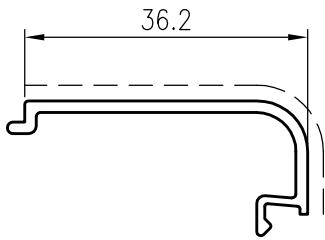

D3290123
sup.vista mm. 48
Kg./m 0.233

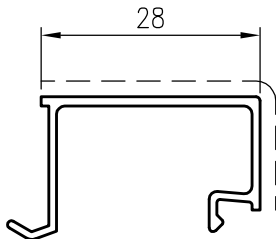

D3290106
sup.vista mm. 42
Kg./m 0.231

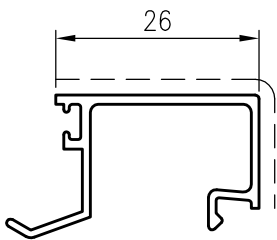

D3290105
sup.vista mm. 40.5
Kg./m 0.231

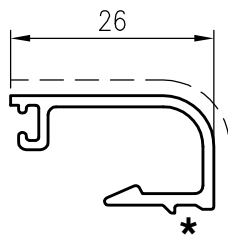

D3290110
sup.vista mm. 38
Kg./m 0.226

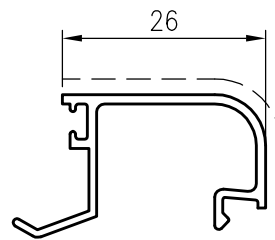

D3290108
sup.vista mm. 38
Kg./m 0.228

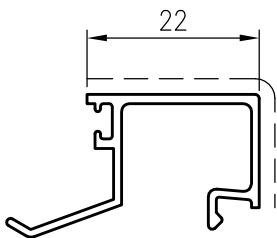

D3290104
sup.vista mm. 36.5
Kg./m 0.225

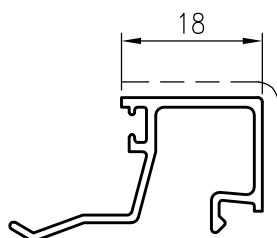

D3290103
sup.vista mm. 32.5
Kg./m 0.221

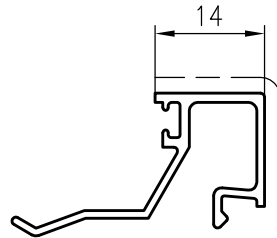

D3290102
sup.vista mm. 28.5
Kg./m 0.215

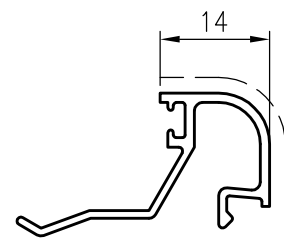

D3290107
sup.vista mm. 26
Kg./m 0.213

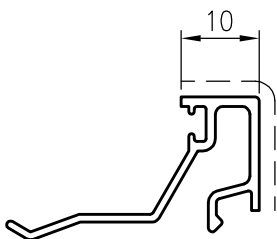

D3290101
sup.vista mm. 24.5
Kg./m 0.210

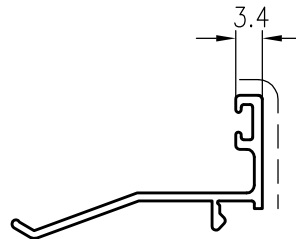

D3290100
sup.vista mm. 18
Kg./m 0.160

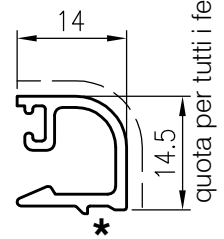

D3290109
sup.vista mm. 25.5
Kg./m 0.181

D3290123

D3290106

D3290105-D3290110-D3290108

D3290104

D3290103

D3290102-D3290107-D3290109

D3290101

D3290100

